



Acuvim II Series Power Meter User's Manual



ACCUEVERGY

Copyright © 2022 V3.00

This manual may not be altered or reproduced in whole or in part by any means without the expressed written consent of Accuenergy.



The information contained in this document is believed to be accurate at the time of publication, however, Accuenergy assumes no responsibility for any errors which may appear here and reserves the right to make changes without notice. Please ask the local representative for latest product specifications before ordering.

Please read this manual carefully before installation, operation and maintenance of the Acuvim II Series Power Meter. The following symbols in this manual are used to provide warning of danger or risk during the installation and operation of the equipment.



Electric Shock Symbol: Carries information about procedures which must be followed to reduce the risk of electric shock and danger to personal health.



Safety Alert Symbol: Carries information about circumstances which if not considered may result in injury or death.

Prior to maintenance and repair, the equipment must be de-energized and grounded. All maintenance work must be performed by qualified, competent accredited professionals who have received formal training and have experience with high voltage and current devices. Accuenergy shall not be responsible or liable for any damages or injuries caused by improper meter installation and/or operation.

Table of Contents

Chapter 1: Introduction	7
1.1 Meter Overview.....	7
1.2 Areas of Application	8
1.3 Functionality.....	9
Chapter 2: Installation.....	14
2.1 Appearance and Dimensions.....	16
2.2 Installation Methods	18
2.3 Wiring.....	22
2.3.1 Power Requirement	22
2.3.2 Voltage Input Wiring.....	23
2.3.3 Current Input Wiring	27
2.3.4 Typical Wiring.....	29
2.3.5 Frequently Used Wiring Methods.....	30
2.3.6 Communication	32
Chapter 3: Meter Display & Parameter Settings.....	34
3.1 Display Panel and Keys	34
3.2 Metering Data	36
3.2.1 Voltage and Current Data.....	36
3.2.2 Power, Power Factor, and Frequency	39
3.2.3 Phase Angles and Unbalance.....	40
3.2.4 Energy	41
3.2.5 TOU Display.....	43
3.3 Statistical Data	45
3.4 Demand Data	46
3.5 Harmonic Data.....	47
3.5.1 Power Quality Data	47
3.5.2 Individual Harmonic Data.....	48
3.6 Expanded I/O Module Data.....	50
3.6.1 Module Selection.....	50
3.7 Meter Setting Mode.....	53
3.7.1 Password Inquiry.....	53
3.7.2 Parameter Selection Mode.....	53

3.7.3 System Settings.....	54
3.7.4 I/O Module Settings.....	57
3.7.5 Communications Module Settings	59
3.7.6 Alarm Settings.....	63
3.8 Page Recovery Function.....	64

Chapter 4: Detailed Functions and Software65

4.1 Acuvue Software	65
4.1.1 Connect using RS485	65
4.2 Basic Analog Measurements.....	68
4.2.1 High Speed Monitoring.....	69
4.3 Demand	70
4.4 Energy	71
4.5 Max/Min.....	72
4.6 Harmonics and Power Quality Analysis.....	73
4.6.1 Harmonics & THD.....	73
4.6.2 Amplitude and Angle.....	74
4.6.3 Phase Angles	75
4.6.4 Sequence Component and Unbalance Analysis.....	76
4.7 Alarm.....	78
4.7.1 Alarm Log	81
4.8 Meter Settings.....	83
4.8.1 Communication	84
4.8.2 Wiring, CT/PT Ratios	84
4.8.3 Demand Settings	86
4.8.4 Energy Reading & Power Factor Settings	86
4.8.5 Load Percentage.....	87
4.9 Time & Date Configuration.....	88
4.10 Data Logging	89
4.10.1 Data Log Setting	89
4.10.2 Retrieving the Data Log	92
4.11 Time-of-Use (TOU).....	93
4.11.1 General TOU Setting	93
4.11.2 Monthly Billing Mode.....	95
4.11.3 TOU Seasons.....	95
4.11.4 TOU Schedule	96

4.11.5 Weekend Settings.....	97
4.11.6 Holiday Settings.....	98
4.11.7 DST Settings	101
4.11.8 Reading the TOU data.....	101
4.12 Power Quality Event Logging and Waveform Capture.....	104
4.12.1 Waveform Capture.....	105
4.12.2 Power Quality Event Logging	107
4.12.3 Waveform Retrieval.....	107
4.13 Dual Source Energy.....	110
4.13.1 Controlling the Energy Direction	111
4.13.2 Bi-Directional Energy Switching Record	112
4.14 Seal Function.....	112
4.14.1 Sealed Nonstandard Parameters.....	114

Chapter 5: Extended Modules 119

5.1 I/O Modules.....	119
5.1.1 Appearance and Dimensions.....	119
5.1.2 I/O Functionality	120
5.1.3 Installation Method	123
5.1.4 I/O Module Wiring	125
5.1.5 IO Module Readings	131
5.1.6 Detection of Remote Signals.....	131
5.1.7 Pulse Counter.....	134
5.1.8 Relay Output	138
5.1.9 Digital Output.....	140
5.1.10 Analog Output	144
5.1.11 Analog Input.....	148
5.2 Profibus Module AXM-PROFI.....	151
5.2.1 Introduction of PROFIBUS Technology	151
5.2.2 PROFIBUS module application notes.....	151
5.2.3 Appearance and Dimensions.....	152
5.2.4 Installation Method	152
5.2.5 Definition of DP Interface.....	153
5.2.6 Cable	153
5.2.7 Bus Terminal	153
5.2.8 Address Setting.....	154

5.2.9 Baud Rate	155
5.2.10 GSD Files.....	155
5.2.11 Information Exchange	155
5.2.12 Format of Function code 01H	156
5.2.13 Format of function code 05H.....	157
5.2.14 Format of function code 02H.....	158
5.2.15 Format of function code 03H.....	159
5.2.16 Format of function code 10H.....	161
5.2.17 32 Word Output Interface	162
5.3 RS485 Module (AXM-485)	163
5.3.1 Communication Parameters Setting.....	163
5.3.2 Function Description of RS485 module.....	163
5.3.3 Appearance and Dimensions.....	164
5.3.4 Installation Method	164
5.3.5 Connection Method	165
5.3.6 Communication Address	166

Chapter 6: Communication Part I 167

6.1 Modbus Protocol Introduction.....	167
6.2 Communication Format.....	169
6.3 Data Address Table and Application Details	173
6.3.1 Data Type.....	173
6.3.2 Relationship between communication value and numerical value	173
6.3.3 System Parameter Setting.....	175
6.3.4 System Status Parameters	178
6.3.5 Date and Time Registers.....	180
6.3.6 100ms Refresh Metering Parameters.....	180
6.3.7 Real Time Metering Parameters	182
6.3.8 Energy Parameters.....	185
6.3.9 TOU (Time-of-Use) Registers	187
6.3.10 Power Quality Parameters	203
6.3.11 Max & Min Values.....	220
6.3.12 Phase Angles.....	226
6.3.13 Sequence Component	226
6.3.14 I/O Module Settings	227
6.3.15 I/O Module Readings Settings.....	233

6.3.16 SunSpec Registers	239
Chapter 6: Communication Part II	244
6.3.17 Over/Under Alarm Setting.....	244
6.3.18 Data Logging	253
6.3.19 Time-of-Use.....	260
Appendix.....	289
Appendix A Technical Data and Specifications	289
Appendix B Ordering Information.....	294

Chapter 1: Introduction

1.1 Meter Overview

Powerful Multi-function Power Meter

The Acuvim II series multi-function digital power meter is designed using MCU (micro controller unit) and DSP (digital signal processing) technology. It integrates three-phase energy measuring and displaying, energy accumulating, power quality analysis, over-under alarming, data logging, and network communication. A vivid LCD with large characters and a time-of-use, programmable backlight provides a clear, real-time data readout.

Ideal for Electric Automation SCADA Systems

The Acuvim II series meter is the ideal choice for replacing traditional analog meters. In addition to providing clear real-time readings on the meter display, it can also be used as a remote terminal unit (RTU) for monitoring and controlling a SCADA system. Users can access all measurement parameters via the standard RS485 communication port (or the optional Ethernet port) with the Modbus protocol.

Energy Management

The Acuvim II series meter is able to measure bidirectional energy as well as four quadrant energy (kWh) and reactive energy (kvarh). It provides maximum/minimum records for power usage and power demand parameters. All power and energy parameters can be viewed remotely via software in order to easily monitor various parameters. In addition, measurement tables can be viewed from our free Acuvim software.

Remote Power Control

This meter is designed to measure and monitor power quality parameters. There are different I/O modules that can be added to the meter. This expands the meters capabilities and provides a very flexible platform for using the meter as a distributed RTU for metering, monitoring, and remote controlling all in one unit.

Power Quality Analysis

By utilizing digital signal processing (DSP) technology, the Acuvim II series meter provides high accuracy power quality analysis and supports remote monitoring via the Ethernet module. The meter continuously updates the metering results and allows users to access the meter online to monitor parameters such as voltage and current harmonics, voltage and current crest factors, voltage and current unbalance factors etc.

Data Logging

The Acuvim IIR meter and Acuvim IIW meter contain 8MB (megabytes) of on-board memory for data logging and historical trending respectively. Since the meters contain real-time clocks, all events and logged data will include a timestamp of when data is recorded.

Time-of-Use

Users can assign up to 4 different tariffs (sharp, peak, valley, normal) to different time periods within a day according to the billing requirements. The meter will calculate and accumulate energy to different tariffs according to the meters internal clock and TOU settings.

Power Quality Event Logging

When a power quality event occurs, such as voltage sag or swell etc, the Acuvim IIW meter will record the timestamp and the triggering condition of the event. It can save up to 50,000 power quality events.

Waveform Capture

The Acuvim IIW contains another 8MB (megabytes) of on-board memory for power quality event logging and waveform capture. The Acuvim IIW can record 100 groups of voltage and current waveform. It logs at 64 points per cycle, and provides the waveform record of 10 cycles before and after the triggering point. It also supports a settable triggering condition.

1.2 Areas of Application

- Power Distribution Automation
- Industry Automation
- Energy Management Systems
- Renewable Energy
- Electric Switch Gear and Control Panels
- Building Automation
- Marine Applications

1.3 Functionality

Multi-function

The Acuvim II meters provide powerful data collection and processing functions. In addition to measuring various parameters, the meter is able to perform demand metering, harmonic analysis, max/min statistic recording, over/under limit alarming, energy accumulating, and data logging.

High Accuracy

The accuracy of voltage and current is 0.1% True-RMS.

The accuracy of power and energy is 0.1% while monitoring all four quadrants.

Compact and Easy to Install

This meter can be installed into a standard ANSI C39.1 (4" round) or an IEC 92mm DIN (square) cutout. With the 51mm depth after mounting, the Acuvim II series meter can be installed in a small cabinet. Mounting clips are used for easy installation and removal.

Easy to Use

All metering data and setting parameters can be accessed by using the keys on the front panel of the meter or by using Modbus via the communication port. Setting parameters are in the EEPROM (Electrical Erasable Programmable Read-Only Memory) so that content will be preserved when the meter is powered off.

Multiple Wiring Modes

The Acuvim II series meter can be used in high voltage, low voltage, three-phase three wires, three-phase four wires and single-phase systems using different wiring mode settings.

High Safety, High Reliability

The Acuvim II series meter was designed according to industrial standards. It can run reliably under high power disturbance conditions. This meter has been fully tested for EMC and safety compliance in accordance with UL and IEC standards.

Function Comparison of Acuvim II Series Meter

Category		Items	Parameters	Acuvim IIR	Acuvim IIW
Metering	Real-Time Metering	Phase Voltage	V1, V2, V3, Vlnavg	•	•
		Line Voltage	V12, V23, V31, Vllavg	•	•
		Current	I1, I2, I3, In, Iavg	•	•
		Power	P1, P2, P3, Psum	•	•
		Reactive Power	Q1, Q2, Q3, Qsum	•	•
		Apparent Power	S1, S2, S3, Ssum	•	•
		Power Factor	PF1, PF2, PF3, PF	•	•
		Frequency	F	•	•
		Load Features	Load Features	•	•
	Four Quadrant Power	Four Quadrant Powers	•	•	
	Energy & Demand	Energy	Ep_imp, Ep_exp, Ep_total, Ep_net, Epa_imp, Epa_exp, Epb_imp, Epb_exp, Eqc_imp, Eqc_exp	•	•
		Reactive Energy	Eq_imp, Eq_exp, Eq_total, Eq_net, Eqa_imp, Eqa_exp, Eqb_imp, Eqb_exp, Eqc_imp, Eqc_exp	•	•
		Apparent Energy	Es, Esa, Esb, Esc	•	•
		Demand	Dmd_P, Dmd_Q, Dmd_S, Dmd_I1, Dmd_I2, Dmd_I3	•	•
TOU	Time-of-Use	Energy/Max Demand	TOU, 4 Tariffs, 12 Seasons, 14 Schedules	•	•
	Daylight Saving Time	Two Formats Adjust	Month/Day/Hour/Minute, Month/Week/First few weeks/Hour/Minute	•	•
	Waveform Capture (Not applicable on 400Hz systems)	Voltage and Current Waveform	Trigger, Manual, DI change, Sag/Dip, Swell, Overcurrent		•

Category		Items	Parameters	Acuvim IIR	Acuvim IIW	
Monitoring	Power Quality	Voltage Unbalance Factor	U_unbl	•	•	
		Current Unbalance Factor	I_unbl	•	•	
		Voltage THD	THD_V1, THD_V2, THD_V3, THD_Vavg	•	•	
		Current THD	THD_I1, THD_I2, THD_I3, THD_Iavg	•	•	
		Individual Harmonics	Harmonics 2nd to 63rd if 400Hz Harmonics 2nd to 15th	•	•	
		Voltage Crest Factor	Crest Factor	•	•	
		TIF	THFF	•	•	
		Current K Factor	K Factor	•	•	
		Statistics	MAX with Timestamp MIN with Timestamp	Each phase of V & I; Total of P, Q, S, PF & F; Each phase THD of V & I; Unbalance factor of V & I	•	•
		Others	Alarm	Over/Under Limit Alarm	V, I, P, Q, S, PF, V_THD & I_THD each phase and total average; Unbalance factor of V & I; Load type; Analog Input of each channel	•
Power Quality Event Logging (N/A on 400Hz systems)	Sag/Dip, Swell		Voltage		•	

Acuvim II Series Power Meter

Category		Items	Parameters	Acuvim IIR	Acuvim IIW
Others	Data Logging	Data Logging 1 Data Logging 2 Data Logging 3	F, V1/2/3/lavg, V12/23/13/lavg, I1/2/3/n/avg, P1/2/3/sum, Q1/2/3/sum, S1/2/3/sum, PF1/2/3, PF, U_unbl, I_unbl, Load Type, Ep_imp, Ep_exp, Ep_total, Ep_net, Eq_imp, Eq_exp, Eq_total, Eq_net, Es, THD_V1/2/3/avg, THD_I1/2/3/avg, Harmonics 2nd to 63rd, Crest Factor, THFF, K Factor, sequence and phase angles, DI counter, AI, AO, Dmd P/Q/S, Dmd I1/2/3Epa_imp; Epa_exp; Epb_imp; Epb_exp; Epc_imp; Epc_exp; Eqa_imp; Eqa_exp; Eqb_imp; Eqb_exp; Eqc_imp; Eqc_exp; Esa; Esb; Esc	•	•
	On-board Memory Size	Memory	Bytes	8MB	16MB
	Communication	RS485 Port, Half Duplex, Optical Isolated	Modbus-RTU/BACnet MSTP	•	•
	Time	Real Time Clock	Year, Month, Date, Hour, Minute, Second	•	•
	400Hz		Only support full-wave energy, support 2nd ~ 15th individual harmonics	•	
Option Module	I/O Option	Switch Status (DI)	Digital Input (Wet)	•	•
		Power Supply for DI	24 Vdc	•	•
		Relay Output (RO)	NO, Form A	•	•
		Digital Output (DO)	Photo-Mos	•	•
		Pulse Output (PO)	By Using DO	•	•
		Analog Input (AI)	0(4)~20mA, 0(1)~5V	•	•
	Communication	Analog Output (AO)	0(4)~20mA, 0(1)~5V	•	•
		Ethernet	Modbus-TCP, HTTP, SNMP, SMTP, SNTIP	•	•
		Profibus-DP	Profibus-DP/V0	•	•
		The second way RS485 Module	Modbus-RTU Protocol	•	•
BACnet	IP	•	•		

• : Function • : Optional Blank: N/A

Chapter 2: Installation

Considerations When Installing Meters

- Installation of the meter must be performed by qualified personnel only, who follows standard safety precautions through the installation procedures. Those personnel should have the appropriate training and experience with high voltage devices. Appropriate safety gloves, safety glasses and protective clothing are recommended.
- During normal operation, dangerous voltage may flow through many parts of the meter including the terminals, any connected Current Transformers (CTs) or Potential Transformers (PTs), all I/O modules and their circuits. All primary and secondary circuits can produce lethal voltages and currents. **AVOID** contact with any current carrying surfaces.
- The meter and its I/O output channels are **NOT** designed as primary protection devices and shall **NOT** be used in primary circuit protection or in an energy limiting capacity. The meter and its I/O output channels can only be used as secondary protection. **AVOID** using the meter under situations where failure of the meter may cause injury or death. **AVOID** using the meter for any application where risk of fire may occur.
- All meter terminals should be inaccessible after installation.
- Do **NOT** perform Dielectric (HIPOT) test to any inputs, outputs, or communications terminals. High voltage testing may damage the meter's electronic components.
- Applying more than the maximum voltage to the meter and/or its modules can withstand will permanently damage the meter and/or its modules. Please refer to the specifications for all devices before applying voltage.
- When removing the meter for service, use shorting blocks and fuses for the voltage leads and power supply to prevent hazardous voltage conditions or damage to CTs. CT grounding is optional.
- Accuenergy recommends using a dry cloth to wipe the meter.



NOTE: IF THE EQUIPMENT IS USED IN A MANNER NOT SPECIFIED BY THE MANUFACTURER, THE PROTECTION PROVIDED BY THE EQUIPMENT MAY BE IMPAIRED.



NOTE: THERE IS NO REQUIRED PREVENTIVE MAINTENANCE OR INSPECTION NECESSARY FOR SAFETY. HOWEVER, ANY REPAIR OR MAINTENANCE SHOULD BE PERFORMED BY THE FACTORY.

DISCONNECT DEVICE: The following part is considered the equipment disconnect device:

A SWITCH OR CIRCUIT-BREAKER SHALL BE INCLUDED IN THE INSTALLATION. THE SWITCH SHALL BE IN CLOSE PROXIMITY TO THE EQUIPMENT AND WITHIN EASY REACH OF THE OPERATOR. THE SWITCH SHALL BE MARKED AS THE DISCONNECT DEVICE FOR THE EQUIPMENT.

FCC Compliance Statement (e.g., products subject to Part 15)

This device complies with Part 15 of the FCC Rules. Operation is subject to the following two conditions:

1. This device may not cause harmful interference, and
2. This device must accept any interference received, including interference that may cause undesired operation.

The installation method is introduced in this chapter. Please read this chapter carefully before beginning installation.

2.1 Appearance and Dimensions

There are two different types of Acuvim II meter design, either panel mount with an LCD display or DIN rail mount with no display. The following figures provide the front view, side view, and rear view of the two different Acuvim II series meters.

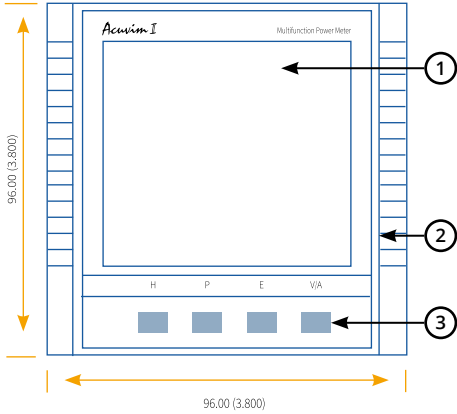

Figure 2-1 Front view of the Meter Display and Remote Display Unit

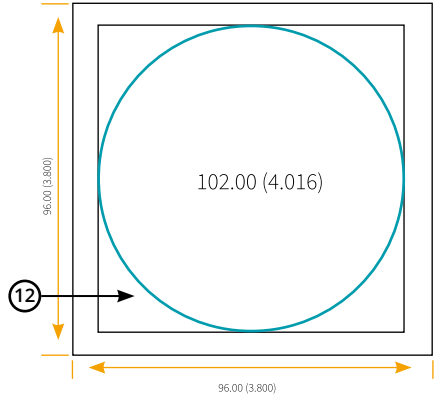

Figure 2-2 Rubber Gasket

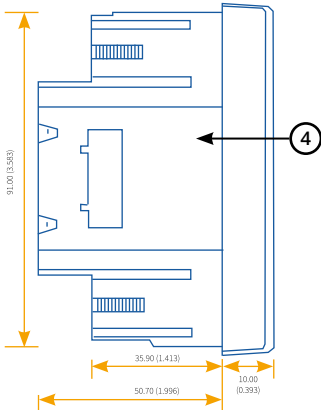

Figure 2-3 Side View of Meter With Display

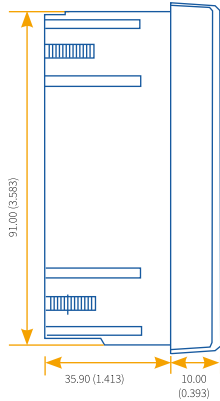

Figure 2-4 Side View of Remote Display Unit

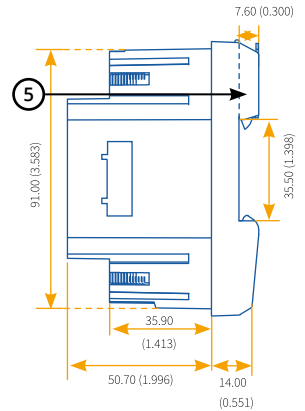

Figure 2-5 Side View of DIN Rail Meter

Unit: mm (inches)

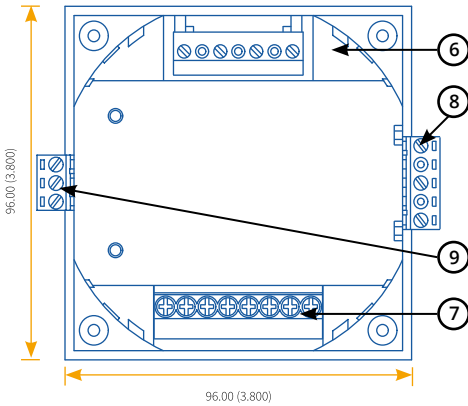

Figure 2-6 Rear View of Acuvim II Meter

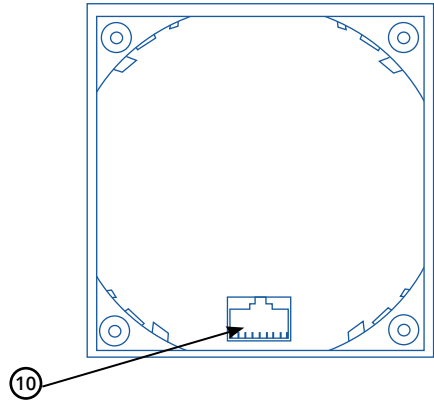

Figure 2-7 Rear View of Remote Display

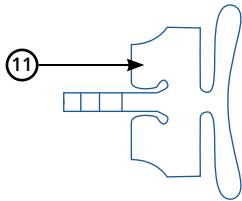

Figure 2-8 Installation Clip

Unit: mm (inches)

The table below specifies the part name and description of the Acuvim II series meter.

Table 2-1 Meter Part Name and Description

Part Name	Description
1) LCD Display	Large bright white backlight LCD display.
2) Front Casing	Visible portion (for display and control) after mounting onto a panel.
3) Key	Four keys are used to navigate through the display and configure settings.
4) Enclosure	The Acuvim II series meter enclosures are made of high strength anti-combustible engineering plastic.
5) DIN rail	Used for installation of 35mm rail of the DIN rail meter.
6) Voltage Input Terminals	Used for voltage input.
7) Current Input Terminals	Used for current input.
8) Power Supply Terminals	The Control Power Input.
9) Communication Terminals	The RS485 communication port on the meter.
10) Interface	Used for linking the remote display unit and the DIN rail meter.
11) Installation Clip	Used for fixing the meter to the panel.
12) Gasket	Rubber gasket inserted between the meter and the cutout to cover up gaps from the round hole.

2.2 Installation Methods

Environmental

Before installation, please check the environment, temperature, and humidity to ensure that the Acuvim II series meter is being placed where optimal performance will occur.

Temperature

- Operation: -25°C to 70°C
- Storage: -40°C to 85°C

Humidity

- 5% to 95% non-condensing

The Acuvim II series meter should be installed in a dry and dust-free environment. Avoid exposing meter to excessive heat, radiation, or high electrical noise source.

Installation Steps

The Acuvim II series meter can be installed into a standard ANSI C39.1 (4-inch round) or an IEC 92mm DIN (square) form.

Panel Mount Installation

1. Cut a square hole or round hole on the panel of the switch gear. The cutting size can be seen in Figure 2-9.

Unit: mm (inches)

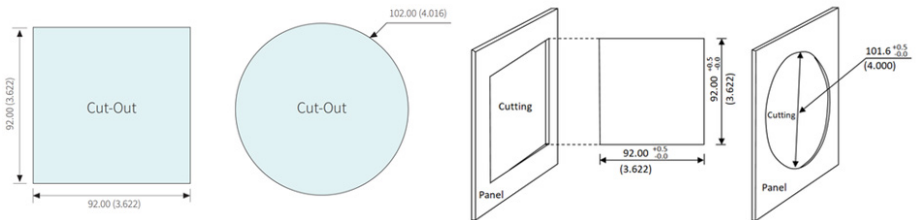

Figure 2-9 - Panel Cutout

2. Remove the clips from the meter and insert the meter into the square hole from the front side.

NOTE: Optional rubber gasket must be installed on the meter before inserting the meter into the cutout.

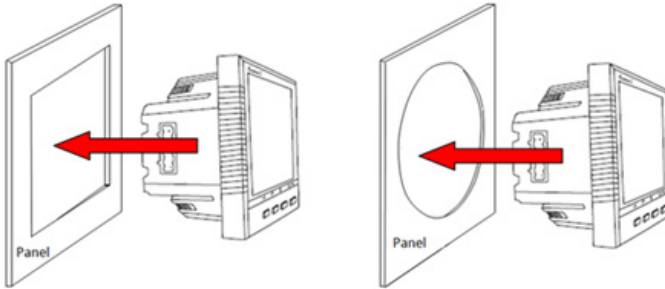

Figure 2-10 - Insert meter into the opening

3. Install the clips on the back side of the meter and secure tightly to ensure that the meter is affixed to the panel.

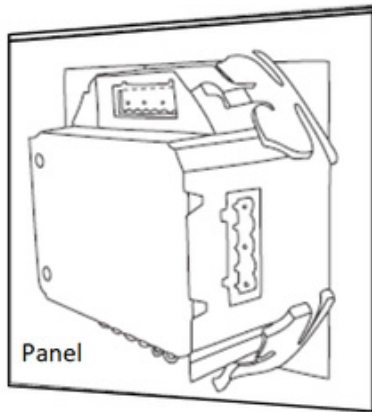

Figure 2-11 - Use the clips to fix the meter to the panel

NOTE: The display of the meter and the remote display unit have the same installation method. The DIN rail meter is simply installed on a 35mm DIN rail.

DIN Rail Installation Method

1. The DIN rail mount option meter is simply installed on a 35mm DIN rail.



AXM-DIN Installation

The AXM-DIN rail adapter provides an easy installation method for panel-mount Acuvim II series meters on DIN rail. Available for all models and I/O options.

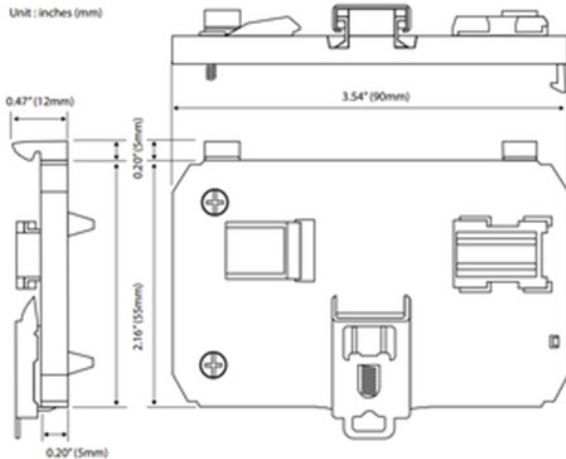

Figure 2-12 - Use the clips to fix the meter to the panel

1. The adapter can be installed directly onto the back of the Acuvim II meter, I/O module, or communications module, if used. Simply hook and screw the ends into the meter base. Once installed, snap the adapter into the 35mm DIN rail.



Figure 2-13 - Install the AXM-DIN rail adapter

2. The AXM-DIN rail adapter can be adjusted for horizontal or vertical DIN rail installations.

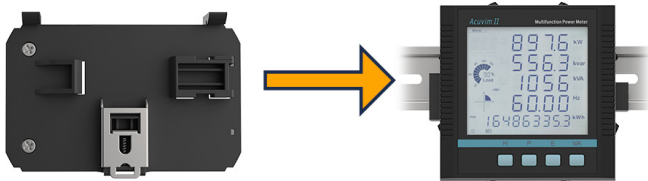

Figure 2-14 - Horizontal DIN rail installation

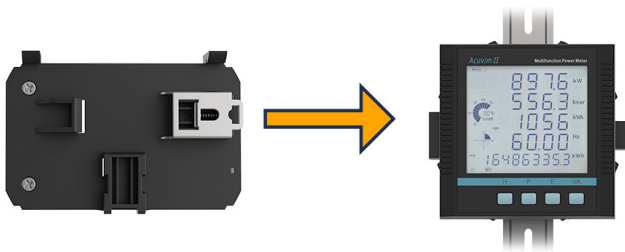

Figure 2-15 - Vertical DIN rail installation

2.3 Wiring

There are four terminal strips at the back of the Acuvim II series meter, they are the voltage input terminal, current input terminal, power supply terminal and the communication port terminal.

The three-phase voltage and current are represented by using 1, 2, and 3 respectively. These numbers have the same meaning as A, B, and C used in other literature.

2.3.1 Power Requirement

Control Power

There are two options for the control power in the Acuvim II series meter:

1. Standard: 100~415Vac (50/60Hz) or 100-300Vdc
2. Low Voltage DC Option: 20-60Vdc

The two options must be chosen according to the application. Please see the ordering information in the appendix for further information.



NOTE: Ensure that the control power terminal of the meter ground is connected to the safety earth of the switch gear.

The meter typically has a low power consumption and can be supplied by an independent source or by the measured load. A regulator or an uninterruptible power supply (UPS) should be used under high power fluctuation conditions. Terminals for the control power supply are 11, 12, and 13 (L, N, and Ground). A switch or circuit breaker shall be included in a building installation. It shall be in close proximity to the equipment, within easy reach of the operator, and shall be marked as the disconnection device for the equipment.

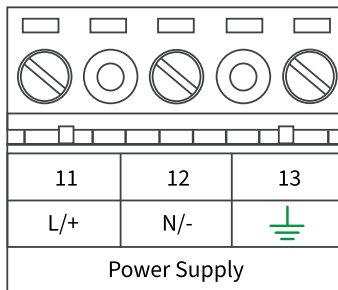

Figure 2-16 - Power Supply Terminal Strip

Choice of wire for the power supply is AWG22-16 or 0.6-1.5mm². Typically, a 1A/250Vac fuse should be used in the auxiliary power supply loop. Terminal 13 must be connected to the ground

terminal of the switch gear. An isolated transformer or EMC filter should be used in the power supply loop if there is a power quality issue with the power supply.

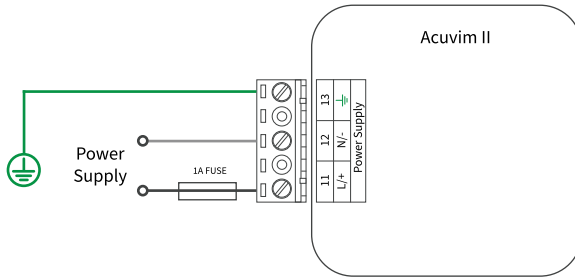

Figure 2-17 - Power Supply

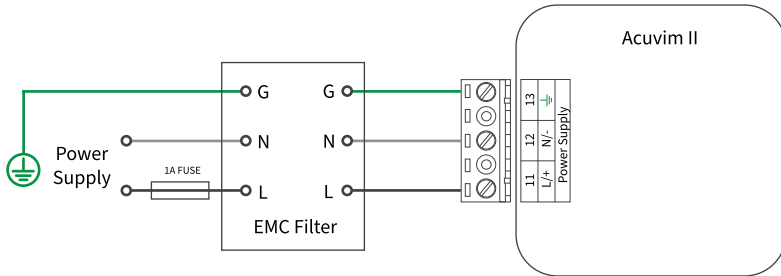

Figure 2-18 - Power Supply with EMC Filter

2.3.2 Voltage Input Wiring

Voltage Input Terminal

The voltage input terminal strip consists of 4 input terminals: V1 (7), V2 (8), V3 (9), and VN (10).

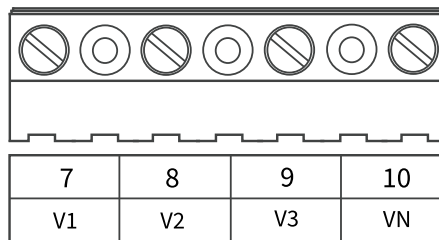

Figure 2-19 - Voltage Input

Acuvim II Series Power Meter

The maximum voltage input for the Acuvim II series meter shall not exceed 400LN/690LL Vac RMS for three-phase or 400LN Vac RMS for single-phase.

In high voltage systems a Potential Transformer (PT) must be used. The typical secondary output for PTs shall be over 100V or 120V. Ensure to select an appropriate PT to maintain the measurement accuracy of the meter. When connecting using the wye configuration wiring method, the PTs primary side rated voltage should be equal to or close to the phase voltage of the system in order to utilize the full range of the PT. When connecting using the delta configuration wiring method, the PTs primary side rated voltage should be equal to or close to the line voltage of the system. A fuse (typically 1A/250Vac) should be used in the voltage input loop. The wire for voltage input is AWG16-12 or 1.3-2.0mm².



NOTE: In no circumstance should the secondary of the PT be shorted. The secondary of the PT should be grounded at one end. Please refer to the wiring diagram section for further details.

Voltage Input Wiring Methods

3-Phase 4-Wire Wye Mode (3LN)

3-Phase 4-Wire wye mode is commonly used in low voltage electric distribution systems. For voltages lower than 400LN/690LL, the voltage lines can be connected directly to the meters voltage input terminal as shown in Figure 2-20a.

For high voltage systems (over 400LN/690LL), PTs (Potential Transformers) are required as shown in Figure 2-20b.

For both scenarios the meter should be set to 3LN.

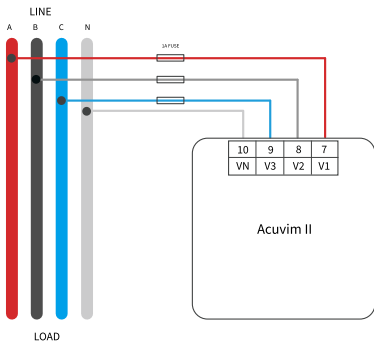

Figure 2-20a - 3LN Direct Connection

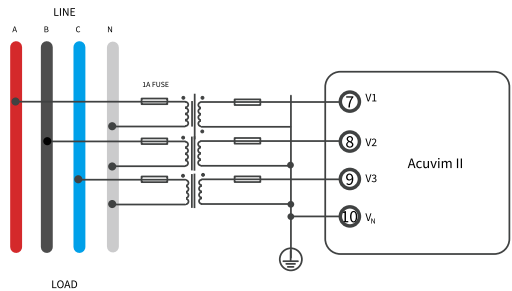

Figure 2-20b - 3LN with 3PTs

3-Phase 3-Wire Delta Mode (3LL)

3-Phase 3-Wire Delta mode is commonly used in low voltage electric distribution systems. For voltages lower than 400LN/690LL, the voltage lines can be connected directly to the meters voltage input terminal as shown in Figure 2-20c.

For high voltage systems (over 400LN/690LL), PTs (Potential Transformers) are required as shown in Figure 2-20d.

For both scenarios the meter should be set to 3LL. Common system voltage for 3-phase delta systems are 480V.

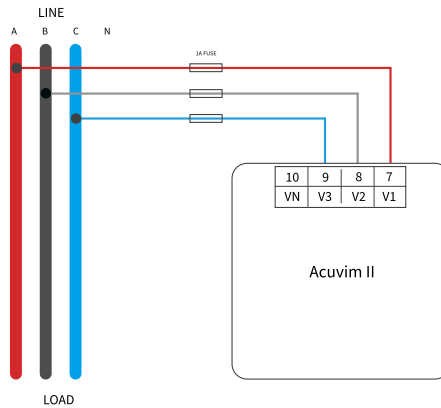

Figure 2-20c - 3LL Direct Connection

3-Phase 3-Wire Open-Phase Delta (2LL)

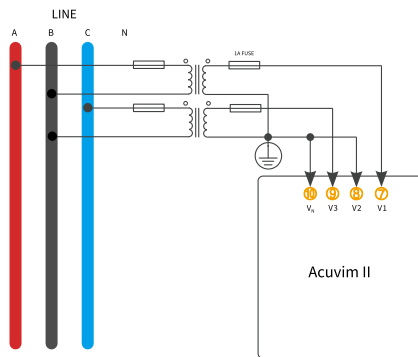

Figure 2-20d - 2LL with 2PTs

2-Phase 3-Wire Split Phase (1LL)

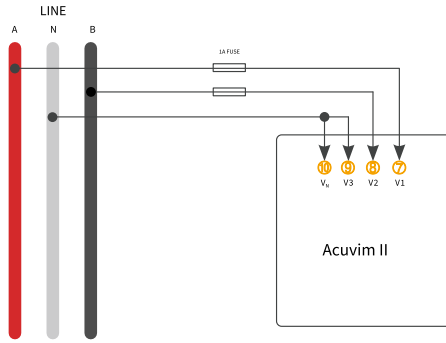

Figure 2-20e - 1LL Direct Connection

1-Phase 1-Wire Single Phase (1LN)

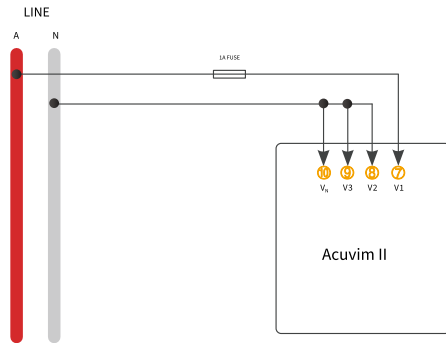

Figure 2-20f - 1LN Direct Connection

Vn Connection

Vn is the reference point of the Acuvim II series meter voltage input. Low wire resistance helps improve the measurement accuracy. Different system wiring modes require Vn connection methods. Please refer to the wire diagram section for more details.

2.3.3 Current Input Wiring

Current Input Terminal

Current Transformers (CTs) are required for most engineering applications. Typical current rating for the secondary side of the CT shall be 5A (standard) or 1A (optional); please refer to the ordering information appendix for further details. CTs must be used if the system's rated current is over 5A. The recommended accuracy of the CT should be better than 0.5% with a rating over 3VA to preserve the meter's accuracy. The wire between the CT and the meter shall be as short as possible. The length of the wire effects measurement accuracy.

The wire size of the current input is AWG15-10 or 1.5-2.5mm².

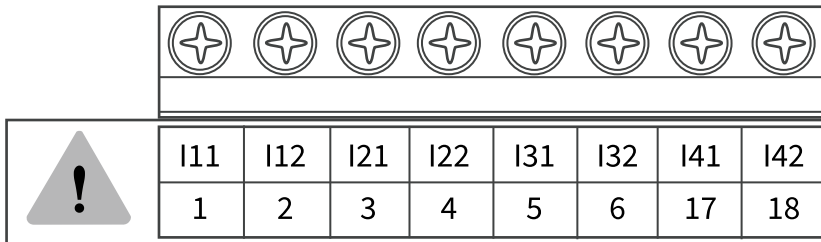

Figure 2-21 - Current Input Terminal

On the current input terminal of the Acuvim II, there are 8 current input channels for 4 CTs.

- Terminal 1 (I11) and 2 (I12) are for the phase A current transformer, where the positive lead of the CT is terminated to I11 and the negative lead is terminated to I12.
- Terminal 3 (I21) and 4 (I22) are for the phase B current transformer, where the positive lead of the CT is terminated to I21 and the negative lead is terminated to I22.
- Terminal 5 (I31) and 6 (I32) are for the phase C current transformer, where the positive lead of the CT is terminated to I31 and the negative lead is terminated to I32.
- Terminal 17 (I41) and 18 (I42) are for the neutral current transformer, where the positive lead of the CT is terminated to I41 and the negative lead is terminated to I42.

NOTE: The secondary side of the CT should not be open circuit in any circumstance when the power is on. There should not be any fuse or switch in the CT loop. One end of the CT loop should be connected to ground if using 5A/1A Current Transformers. If using 333mV/mA/Rogowski coil current transformers a ground connection is not required.

3CT

The 3CT current wiring configuration can be used when either 3CTs are connected (as shown in Figure 2-22) or when 2 CTs are connected (as shown in Figure 2-23). In either case, there is current flowing through all three circuit terminals.

For any RCT/mV/mA CT, do NOT ground the CTs. The figures below have the current input wiring for both 5A/1A CTs as well as RCT/mV/mA CTs.

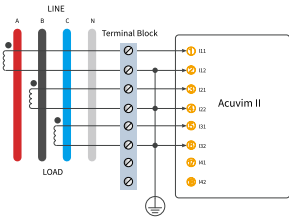

Figure 2-22a - 3 CT 5A/1A

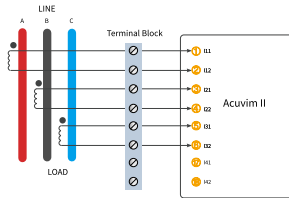

Figure 2-22b - 3 CT 333mV/mA

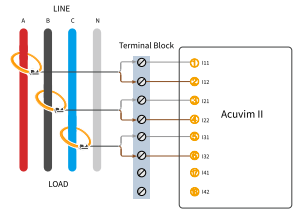

Figure 2-22c - 3CT Rogowski Coil (RCT)

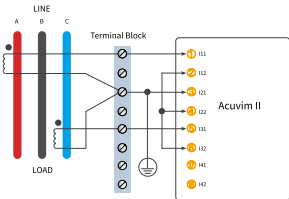

Figure 2-23a - 3CT wiring for 5A/1A CTs with 2CT in open-phase delta systems

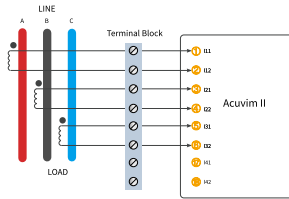

Figure 2-23b - 3CT wiring for 333mV/mA CTs in open-phase delta systems

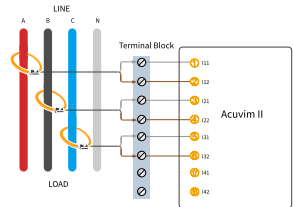

Figure 2-23c - 3CT wiring for Rogowski Coil (RCT) in open-phase delta systems

2 CT

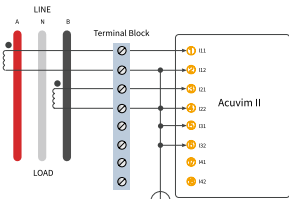

Figure 2-24a - 2CT wiring for 5A/1A CTs in 1LL split-phase systems

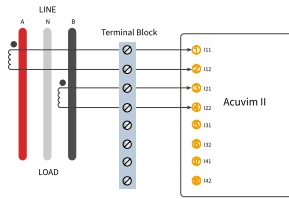

Figure 2-24b - 2CT wiring for 333mV/mA CTs in 1LL split-phase systems

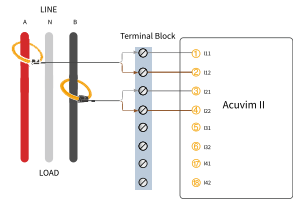

Figure 2-24c - 2CT wiring for Rogowski Coil (RCT) in 1LL split-phase systems

1 CT

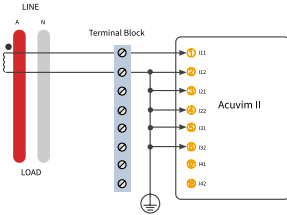

Figure 2-25a - 1CT wiring for 5A/1A CTs in 1LN single phase systems

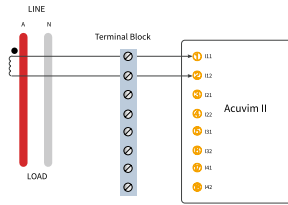

Figure 2-25b - 1CT wiring for 333mV/mA CTs in 1LN single phase systems

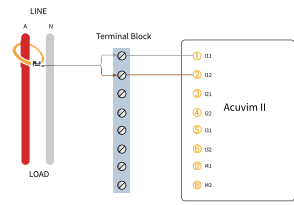

Figure 2-25c - 1CT wiring for Rogowski Coil (RCT) in 1LN single phase systems

2.3.4 Typical Wiring

Wiring Modes

This meter can satisfy almost any kind of three-phase wiring scenario. Please read this section carefully before choosing the suitable wiring method for your power system.

Voltage and current input wiring mode can be set separately in the meters parameter settings:

- The voltage wiring mode can be set as 3-phase 4-line Wye (3LN), 3-phase 3-line direct connection (3LL), 3-phase 3-line open delta (2LL), single phase 2-line(1LN), and single phase 3-line(1LL).
- The current input wiring mode can be set as 3CT, 2CT, and 1CT. The voltage mode can be grouped with the current mode as 3LN-3CT (3CT or 2CT, 3LL-3CT, 2LL-3CT, 2LL-2CT, 1LL-2CT, 1LN-1CT).

2.3.5 Frequently Used Wiring Methods

In this section, the most common voltage and current wiring combinations are shown in different diagrams. In order to display measurement readings correctly, please select the appropriate wiring diagram for your setup and application.

Typical Wiring Diagrams

1. 3LN-3CT with 3 CTs

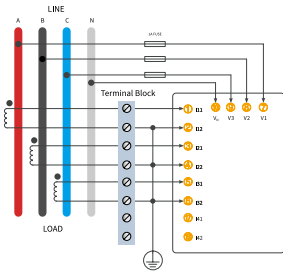

Figure 2-26a 3LN-3CT wiring using 5A/1A CTs

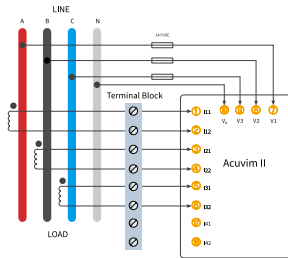

Figure 2-26b 3LN-3CT wiring using RCT/333mV/mA CTs

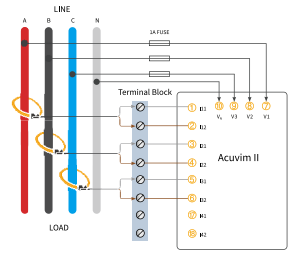

Figure 2-26c 3LN-3CT wiring using Rogowski Coils

2. 3LN-3CT using PTs

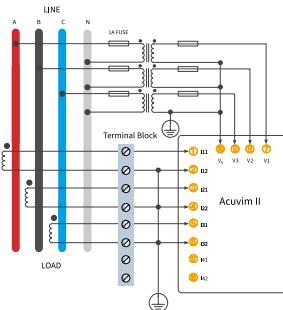

Figure 2-27a 3LN-3CT configuration with PTs using 5A/1A CTs

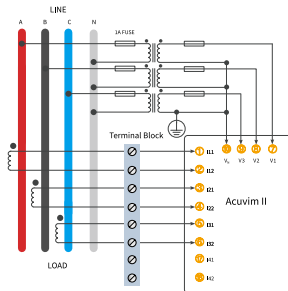

Figure 2-27b 3LN-3CT configuration with PTs using 333mV/mA CTs

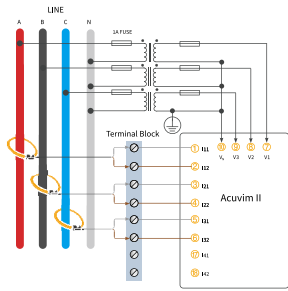

Figure 2-27c 3LN-3CT configuration with PTs using Rogowski Coils

3. 3LL-3CT

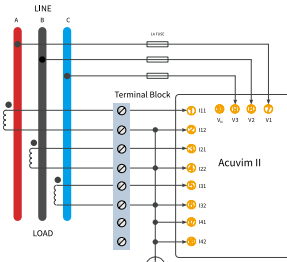

Figure 2-28a 3LL-3CT configuration using 5A/1A CTs

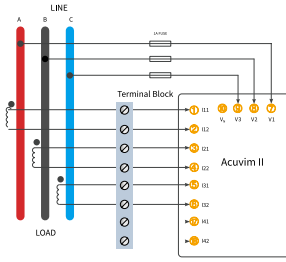

Figure 2-28b 3LL-3CT configuration using 333mV/mA CTs

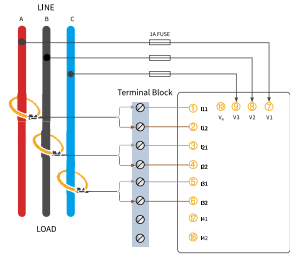

Figure 2-28c 3LL-3CT configuration using Rogowski Coils

4. 2LL-3CT

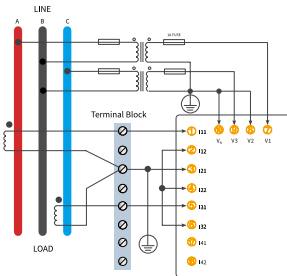

Figure 2-29a 2LL-3CT wiring with PTs using 5A/1A CTs

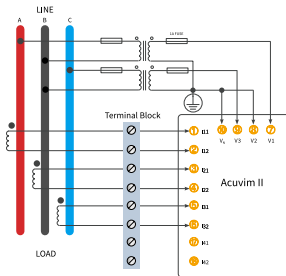

Figure 2-29b 2LL-3CT wiring with PTs using 333mV/mA CTs

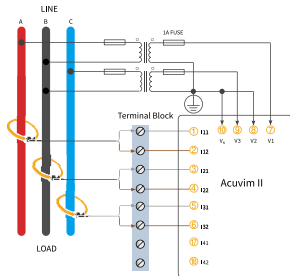

Figure 2-29c 2LL-3CT wiring with PTs using Rogowski Coils

5. 1LN-1CT

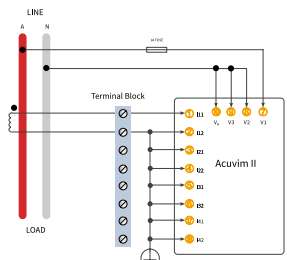

Figure 2-30a 1LN-1CT configuration using 5A/1A CTs

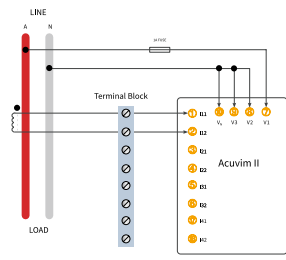

Figure 2-30b 1LN-1CT configuration using 333mV/mA CTs

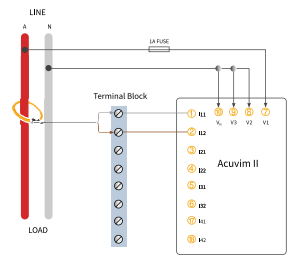

Figure 2-30c 1LN-1CT configuration using Rogowski Coils

6. 1LL-2CT

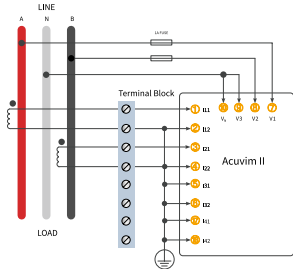

Figure 2-31a 1LL-2CT configuration using 5A/1A CTs

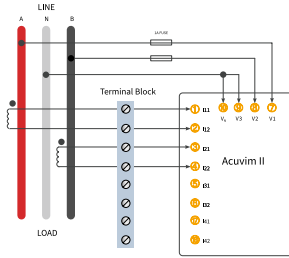

Figure 2-31b 1LL-2CT configuration using 333mV/mA CTs

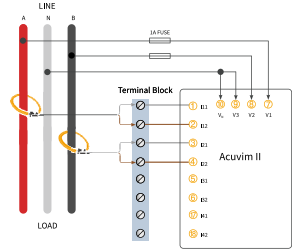

Figure 2-31c 1LL-2CT configuration using Rogowski Coils

2.3.6 Communication

The Acuvim II series meter uses RS485 serial communication and the Modbus RTU protocol. The terminals of communication are A, B, and S (14,15,16).

- **A** is the positive differential signal
- **B** is the negative differential signal
- **S** is connected to the shield of the twisted pair cables

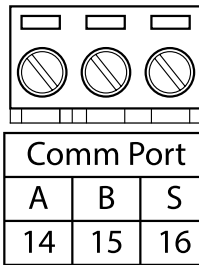

Figure 2-32 Communication Port

Figure 2-33 shows the wiring of the RS485-USB converter to the meter’s communication port terminals. There can be a maximum of 32 devices that can be connected on a RS485 bus.

For the wiring, use a good quality, shielded twisted pair cable, AWG22 (0.5mm²) or higher. The overall length of the RS485 cable connecting all devices should not exceed 1200m (4000ft).

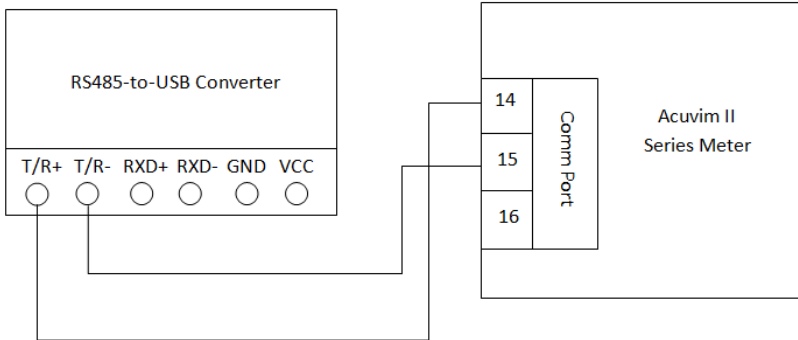

Figure 2-33 RS485-USB connection to Acuvim II series meter

The Acuvim II series meter is used as the slave device of masters such as a PC, PLC, Data Collector or RTU. If the master does not have a RS485 communication port, a converter (such as a RS232/RS485 or a USB/RS485 converter) will be required. Typical RS485 network topologies includes line, circle, and star (wye). The shield of each segment of the RS485 cable must be connected to the ground at one end only.

Every A(+) should be connected to A(+), B(-) to B(-), or it will influence the network, or even damage the communication interface.

The connection topology should avoid "T" type topology, meaning there is a new branch and it does not begin at the beginning point.

Keep communication cables away from sources of electrical noise whenever possible.

When using long communication cables to connect several devices, an anti reflecting resistor (typical value 120Ω-300Ω/0.25W) is normally added to the end of the cable beside the last meter if the communication quality is distorted.

Use RS232/RS485 or a USB/RS485 converter with an optical isolated output and surge protection.

Chapter 3: Meter Display & Parameter Settings

This chapter describes how to view real time metering data and setting parameters using different key combinations on the meter.

3.1 Display Panel and Keys

The front of the Acuvim II series meter consists of an LCD screen and four control keys. All the display segments are illustrated in Figure 3-1. Users should note that all the segments will not display in a single page under normal conditions.

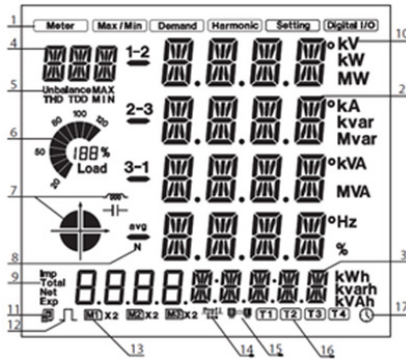















Figure 3-1 All display segments

The icons displayed in figure 3-1 can be explained in the following table:

Table 3-1 All display segments

SN	Display	Description
1	Display Mode	Shows different modes on the display area. <i>Meter</i> : real-time measurement <i>Max/Min</i> : Statistical data <i>Demand</i> : Power demand data <i>Harmonic</i> : Harmonic data <i>Setting</i> : Parameter/meter settings <i>Digital I/O</i> : Viewing I/O module data.
2	Four lines of "7" digits in the metering area	The numeric metering data will be displayed here.
3	Four "8" and five "8" digits	Display energy data and real-time clock. Also used for the setting mode and digital I/O mode display.

SN	Display	Description
4	Three "8" digits 	Item Icons: <i>U</i> for voltage <i>I</i> for current <i>P</i> for active power <i>Q</i> for reactive power <i>S</i> for apparent power <i>PF</i> for power factor <i>F</i> for frequency  for phase angles <i>DMD</i> for demand <i>Mxx</i> for expanded I/O module type and display setting page number.
5	Unbalance, THD, TDD, MAX, MIN	Item Icons: <i>Unbalance</i> for unbalance of the voltage and current; <i>THD</i> for total harmonics distortion; <i>TDD</i> for total demand distortion; <i>MAX</i> for maximum and <i>MIN</i> for minimum.
6	Load Rate - 	Displays the percentage of load to the rated current or power.
7	Four Quadrant Icon:  Load Type Icon: 	 : Quadrant of the system power  : Inductive Load  : Capacitive Load
8	1-2, 2-3, 3-1, avg, N	<i>1, 2, 3</i> : Represents 3 phases <i>A, B, C</i> <i>1-2, 2-3, 3-1</i> : Represents 3 phase line to line <i>AB, BC, CA</i> <i>avg</i> : Represents the average <i>N</i> : stands for neutral
9	Energy icon: Imp, Total, Net, Exp	<i>Imp</i> : Import Energy <i>Total</i> : Absolute sum of Import and Export energy <i>Net</i> : Algebraic sum of Import and Export energy <i>Exp</i> : Export Energy
10	Units Measured	Voltage: <i>V, kV</i> Current: <i>A, kA</i> Active Power: <i>kW, MW</i> Reactive Power: <i>kvar, Mvar</i> Apparent Power: <i>kVA, MVA</i> Frequency: <i>Hz</i> Active Energy: <i>kWh</i> Reactive Energy: <i>kvarh</i> Apparent Energy: <i>kVAh</i> Percentage: % Phase Angle: °
11	Communication Icon 	No Icon: no communication One Icon: query sent Two Icons: query sent and response received

SN	Display	Description
12	Energy pulse output indicator 	No Icon: no pulse output With Icon: icon blinks when sending pulse output
13	Expanded I/O module indicator M1 x2 M2 x2 M3 x2	<i>M1</i> : one AXM-IO1 connected <i>M1x2</i> : two AXM-IO1 connected <i>None</i> : no AXM-IO1 connected <i>M2</i> : one AXM-IO2 connected <i>M2x2</i> : two AXM-IO2 connected <i>None</i> : no AXM-IO2 connected <i>M3</i> : one AXM-IO3 connected <i>M3x2</i> : two AXM-IO3 connected <i>None</i> : no AXM-IO3 connected
14	Profibus Module Indicator 	Icon: Profibus module connected No Icon: Profibus module not connected
15	Ethernet Module Indicator 	No Icon: Ethernet module not connected With Icon: Ethernet module connected when the Second Communication Protocol is set as Other, Wi-Fi module connected when the Second Communication Protocol is set to Wi-Fi, BACnet module connected when the Second Communication Protocol is set to BACnet, Mesh module connected when the Second Communication Protocol is set to Mesh.
16	T1 T2 T3 T4	Current Tariff
17	Time Icon 	Time Display

There are four keys on the front panel of the meter, labeled **H, P, E, V/A** from left to right. These four keys are used to read the real-time metering data, set parameters, and navigate the meter.

3.2 Metering Data

To view the metering data, press **H** and **V/A** simultaneously for about one second then release; this will activate the display mode selection and the cursor will begin flashing. Press **P** or **E** to move the flashing cursor right or left. To enter the metering mode, move the cursor to **Meter** then press **V/A**. In the metering mode, the meter displays measurements such as voltage, current, power, power factor, phase angle, unbalance, etc.

3.2.1 Voltage and Current Data

To view the voltage and current, press **V/A** while in metering mode.

The screen will roll to the next page when **V/A** is pressed again. It will go back to the first screen if you press **V/A** at the last screen. The following figure shows the screen sequence:

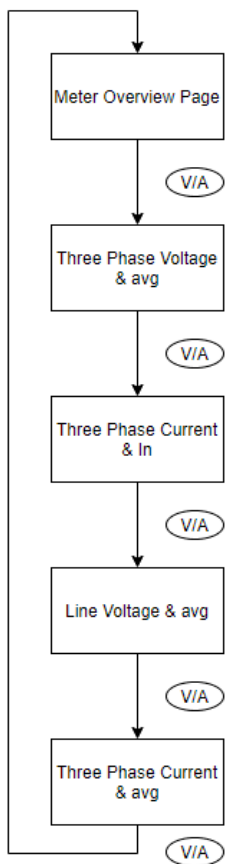

Figure 3-2 - Voltage and Current screen sequence

NOTE: When the meter is set to 2LL or 3LL, there is no phase voltage or neutral current displayed. Therefore, only the third screen (line voltage & avg) and the fourth screen (three-phase current & avg) will be displayed. When the meter is set to 1LN, only phase A voltage and phase A current will be displayed; no other screens will be displayed. When the meter is set to 1LL, no phase C voltage or phase C current will be displayed.

Acuvim II Series Power Meter

Figure 3-3 shows an image of the three-phase voltage reading, where **1** represents phase A, **2** represents phase B, **3** represents phase C, and **avg** represents the average phase voltage.

Similarly in Figure 3-4, the three-phase current and average can be seen in the same representation.

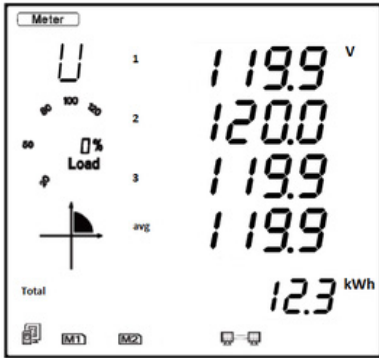

Figure 3-3 - Three-Phase Voltage Page

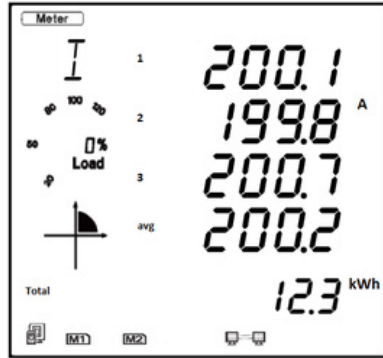

Figure 3-4 -Three-Phase Current Page

In the voltage and current screen sequence the very first page provides users with an overall summary of the metering values for the Acuvim II meter. Figure 3-5 shows the main summary page of the Acuvim II where the top line of data refers to the average line-to-line voltage, the second refers to the total power of the system, the third line refers to the average current, the fourth line refers to the total system power factor, and the very last line refers to the total energy.

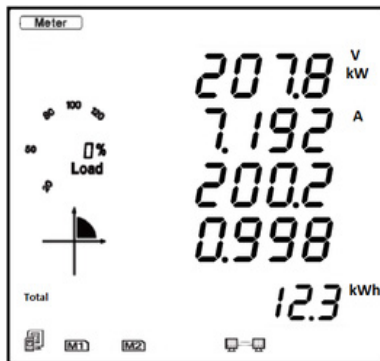

Figure 3-5 Meter Summary Page

3.2.2 Power, Power Factor, and Frequency

To view all power related data, press **P** while in metering mode.

The screen will roll to the next page when **P** is pressed again. It will go back to the first screen if you press **P** at the last screen. The following figure shows the screen sequence:

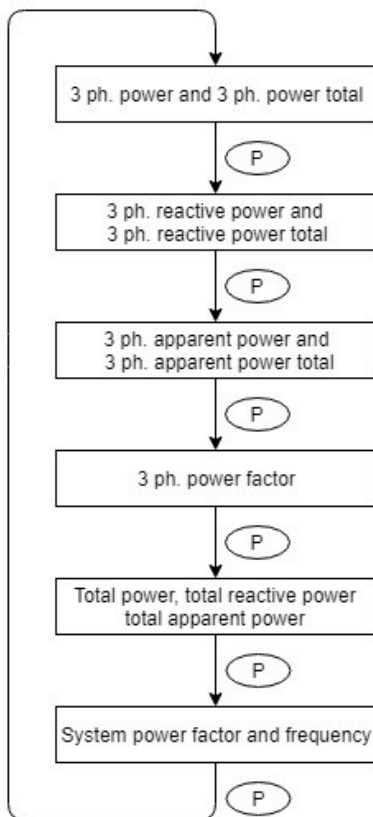

Figure 3-6 - Power, Power Factor, and Frequency screen sequence

NOTE: When the meter is set to 2LL or 3LL, only the fifth screen (system power) and the sixth screen (system power factor & frequency) will be displayed. When the meter is set to 1LN only phase A power and phase A power factor will be displayed. When the meter is set to 1LL, no phase C power and phase C power factor will be displayed.

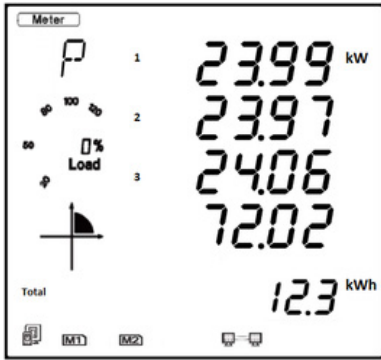

Figure 3-7 - Three-Phase Power Page

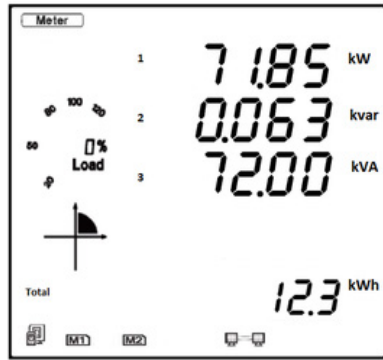

Figure 3-8 - Total System Power Page

3.2.3 Phase Angles and Unbalance

To view the phase angle and unbalance data, press **H** while in metering mode.

The screen will roll to the next page when **H** is pressed again. It will go back to the first screen if you press **H** on the last screen. The following figure shows the screen sequence:

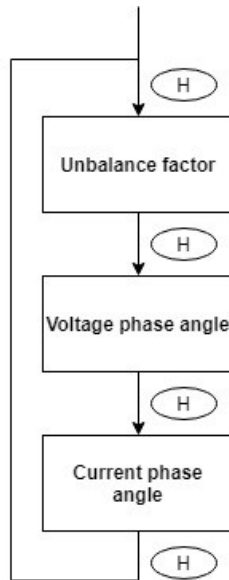

Figure 3-9 - Phase Angle and Unbalance screen sequence

NOTE: When using 2LL or 3LL wiring modes, the voltage here stands for line-to-line voltage. Otherwise, the voltage stands for line-to-neutral voltage. When the meter is set to 1LN, only phase A current to phase A voltage angle will be displayed. When the meter is set to 1LL, no phase C voltage or current to phase A voltage angle will be displayed.

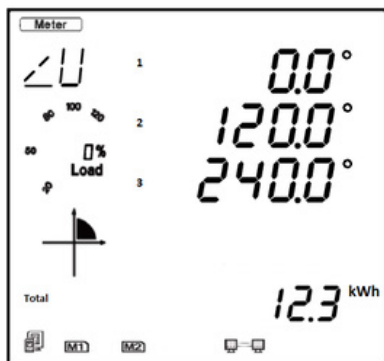

Figure 3-10 - Voltage Phase Angle Page

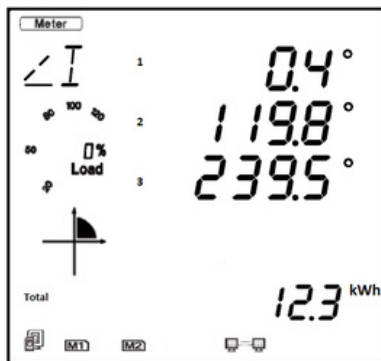

Figure 3-11 Current Phase Angle Page

3.2.4 Energy

To view the energy and real time clock on the meter, press the **E** button. The screen will roll to the next page when **E** is pressed again. It will go back to the first screen if you press **E** at the last screen.

The Accuim II series meter can be set to record either primary or secondary energy. The unit of energy is kWh for active energy, kvarh for reactive energy, and kVAh for apparent energy. The running time has a resolution of 0.01h. The meter begins accumulating time when it is initially powered up. The accumulated time is stored in the non-volatile memory and can be reset via communication or from the meter's display.

The energy reading on the Accuim II meter can be read at the bottom of the display, where users can cycle between different types of energy on any metering page on the meter except for the Meter Summary page. The metering summary page only displays the total energy (kWh). The following flow chart shows the screen sequence for the energy readings.

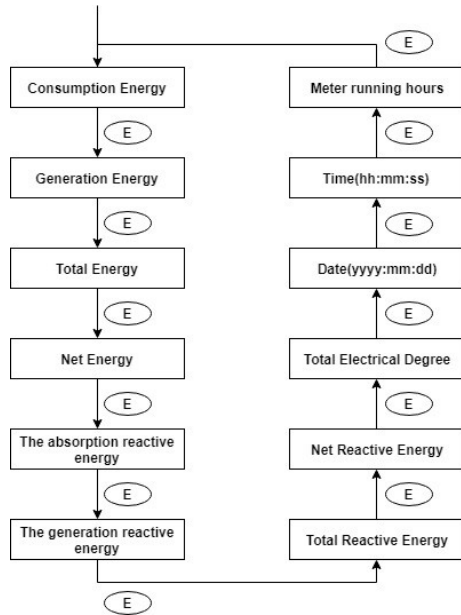

Figure 3-12 - Energy and Real Time Clock screen sequence

There are different types of energy that the Acuvim II meter can measure, Figure 3-13 shows the Import Active Energy represented by the *IMP* icon and the *kWh* unit.

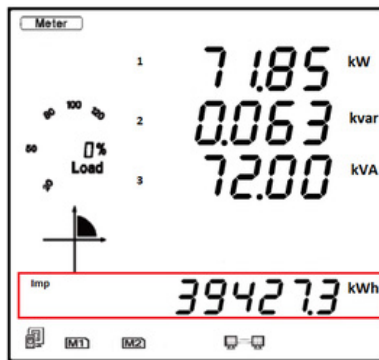

Figure 3-13 - Import Active Energy

Table 3-2 shows the different icons and units for all the energy measurements in the Acuvim II meter.

Table 3-2 Energy Parameter Table

SN	Parameter	Unit
Imp	Import Energy	kWh
Exp	Export Energy	kWh
Net	Net Energy	kWh
Total	Total Energy	kWh
Imp	Import Reactive Energy	kvarh
Exp	Export Reactive Energy	kvarh
Net	Net Reactive Energy	kvarh
Total	Total Reactive Energy	kvarh
	Apparent Energy	kVAh

The meter’s time can also be found in the energy screen sequence. Figure 3-14 shows the date displayed on the meter screen. The date is read as YYYY.MM.DD; the figure below shows the date as April 28, 2020. In addition, when viewing the time/date on the meter display, the time icon will be displayed on the bottom right corner of the meter screen.

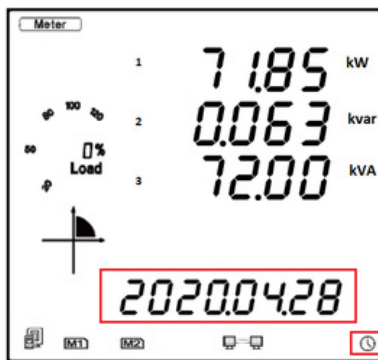

Figure 3-14 - Time & Date Reading

3.2.5 TOU Display

In the metering mode, press **P** and **E** simultaneously to enter the TOU (Time-of-Use) mode. In the TOU mode, the meter displays the energy, maximum demand, and its time in different tariffs.

The screen sequence for the TOU data can be seen in Figure 3-15:

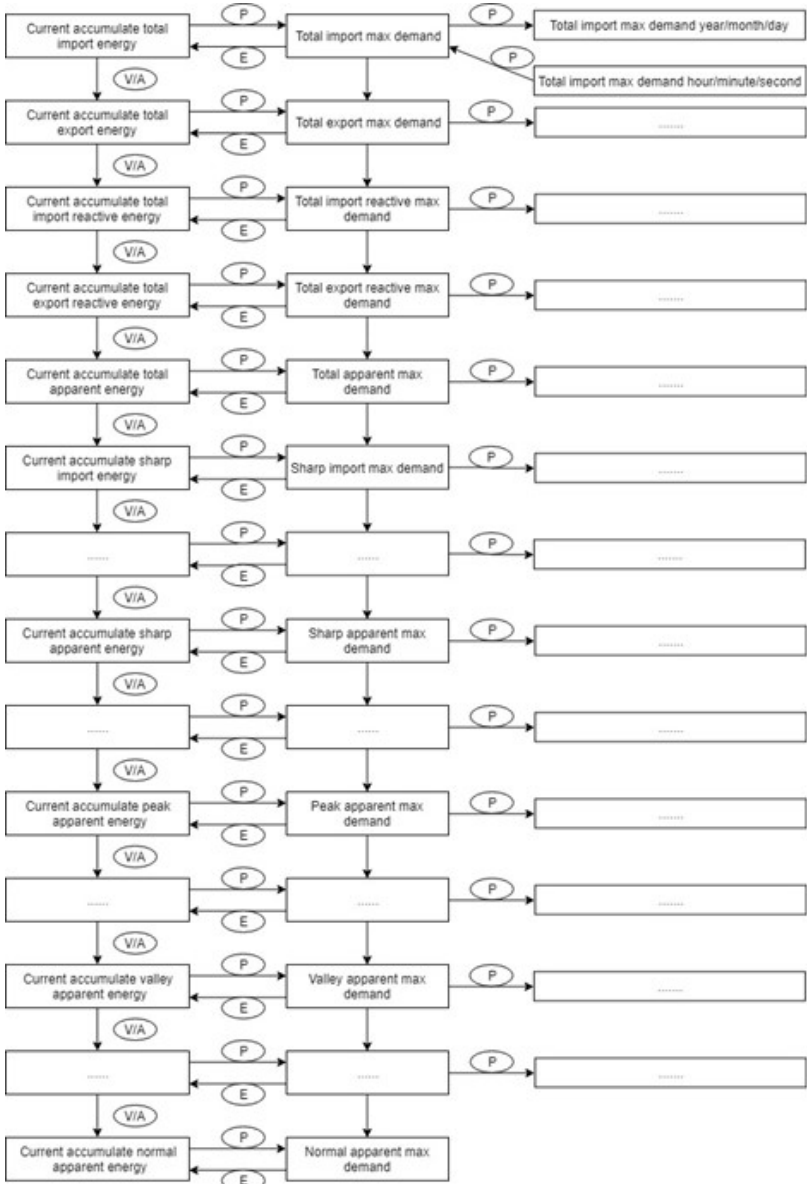

Figure 3-15 - TOU screen sequence

3.3 Statistical Data

In the statistical data mode, the meter displays the maximum and minimum values for voltage, current, power, power factor, unbalance, demand, THD, etc. To change the mode of the Acuvim II meter to view statistical data, press **H** and **V/A** simultaneously for about one second then release; the screen will go blank and the cursor will begin flashing. Press either **P** or **E** to move the flashing cursor over to **Max/Min** and press **V/A** to enter and view the statistical data.

When **P** is pressed, the screen will roll to the next page, and will roll back to the first screen when pressed at the last page. When **E** is pressed, the screen will roll back to the previous page, and will roll back to the last screen when pressed at the first page.

Press **V/A** to switch the view between maximum and minimum. For example, if the current display is showing the maximum phase voltage value, then **V/A** is pressed, the display will show the minimum phase voltage value. If **V/A** is pressed again, the display will switch back to show the maximum phase voltage value. The following figure shows the screen sequence:

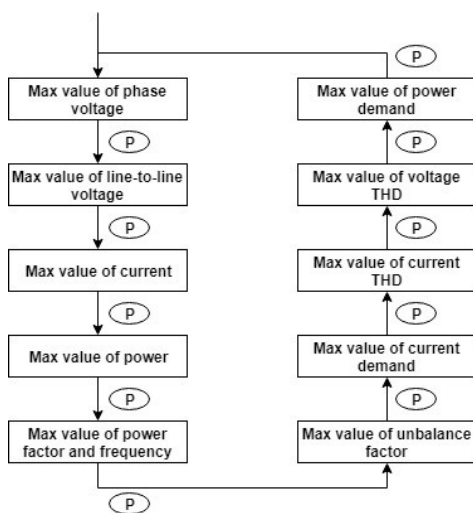

Figure 3-16 - Max/Min screen sequence

NOTE: The figure shows the rolling sequence when **P** is pressed. The sequence would be reversed if users press **E** to roll between screens. When the meter is set to 2LL or 3LL, the first screen (max value of phase voltage) will not be displayed. When the meter is set to 1LL, there are no such displays as phase C voltage, Ubc and Uca line voltage, phase C current, three-phase voltage and current unbalance factor, Uc and Ic THD, phase C current demand, etc.

NOTE: The timestamp for the max/min parameters can be viewed only from the Acuvim software or through Modbus communication. There are no commands associated with the H button in the Max/Min display mode.

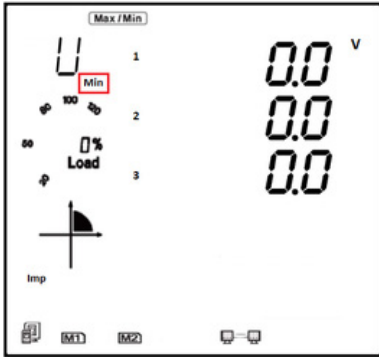

Figure 3-17 Acuvim II Minimum Readings

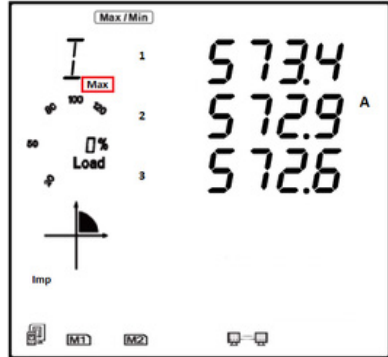

Figure 3-18 Acuvim II Maximum Readings

3.4 Demand Data

To view the demand data, press **H** and **V/A** simultaneously for about one second then release; the screen will go blank and the cursor will begin flashing. Press either **P** or **E** to move the flashing cursor over to **Demand** and press **V/A** to view the meters demand data. The first screen that is shown is the demand of active power, reactive power, and apparent power. Press either **P** or **E** to view the current demand of phase A, phase B, and phase C. The power demand and current demand are the only two screens that can be read in the demand mode.

NOTE: When the meter is set to 1LL, there is no phase C current demand displayed. When the meter is set to 1LN, no phase B and C current demand will be displayed.

NOTE: There are no commands associated with the V/A and H button in the demand readings page.

Figure 3-19 shows the power demand screen that has a system active power demand of 112.7 kW, system reactive power demand of 0.063 kvar, and a system power demand of 115.1 kVA.

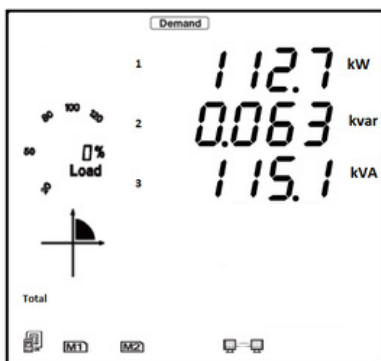

Figure 3-19 Power Demand Screen

3.5 Harmonic Data

In the Harmonic data mode, the meter displays the individual harmonic data for voltage and current, Total Harmonic Distortion, odd Harmonic Distortion, even Harmonic Distortion, Crest Factor, and K Factor. To view the Harmonic data, press **H** and **V/A** simultaneously for about one second then release; the screen will go blank the cursor will begin flashing. Press either **P** or **E** to move the flashing cursor over to **Harmonic** and press **V/A** to view the Harmonic data of the meter.

3.5.1 Power Quality Data

While in the Harmonic data mode, press **H** to display the power quality data. By pressing **H** again, the screen will roll to the next page and will roll back to the first screen when **H** is pressed at the last page. Figure 3-20 shows the screen sequence for the power quality parameters.

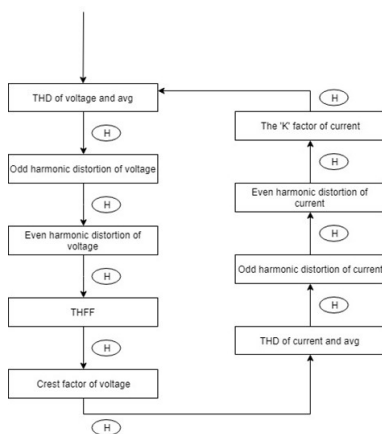

Figure 3-20 - Power Quality Screen Sequence

NOTE: When the meter is set to 1LN, only phase A is displayed for voltage THD, voltage odd harmonic distortion, voltage even harmonic distortion, THFF, voltage crest, current THD, current odd harmonic distortion, current even harmonic distortion, and current K factor. When the meter is set to 1LL phase C is not displayed.

Figure 3-21 below shows the Total Harmonic Distortion for Voltage, where Phase A THD is 2.050%, Phase B THD is 1.990%, Phase C THD is 1.920%, and the Average Phase Voltage THD is 1.986%.

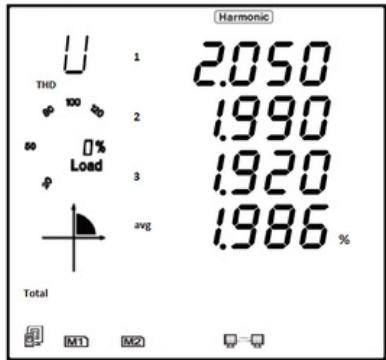

Figure 3-21 - Harmonic Distortion Reading

3.5.2 Individual Harmonic Data

While in harmonic mode, press **V/A** to switch from the THD parameters to the individual harmonic data display.

In the harmonic data display, the harmonic order will increase by one each time **P** is pressed and will return to the 2nd Harmonic when **P** is pressed at the 63rd harmonic. The harmonic order will decrease by one each time **E** is pressed and will return to the 63rd when **E** is pressed at the 2nd harmonic.

Press **V/A** to switch the display between voltage harmonics and current harmonics.

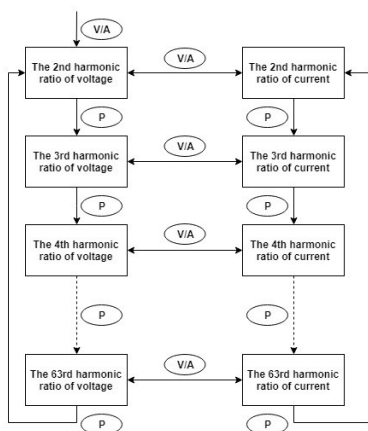

Figure 3-22 - Individual Harmonic data screen sequence

NOTE: The figure shows the rolling sequence when pressing P. If the E button is pressed, the sequence will be reversed. When the meter is set to 1LN, only phase A is displayed for voltage and current harmonic magnitudes. When the meter is set to 1LL, phase C is not displayed for voltage and current harmonic magnitudes.

Figure 3-23 shows the 5th order harmonic readings for current: Phase A is 12.35%, Phase B is 4.940%, and Phase C is 7.541%.



Figure 3-23 - Individual Harmonic Reading

3.6 Expanded I/O Module Data

To view the data from the expanded I/O modules, press **H** and **V/A** simultaneously for about one second then release; the screen will go blank, and the cursor will begin flashing. Press either **P** or **E** to move the cursor right or left until it is on **Digital I/O**, then press **V/A** to view the I/O data.

In the expanded I/O module data mode, the meter displays the data from the expanded I/O modules such as the DI status, DI pulse counter, relay status, analog input, analog output etc.

In this mode the first page is the module selection. You can choose to view the available modules that are attached to the meter. If no expanded I/O modules are connected, the screen will display **NO IO**.

3.6.1 Module Selection:

In the module selection screen press **P** to move the cursor downwards, the cursor will move to the top when it reaches the bottom. If only one module is connected, pressing **P** will have no effect.

Press **E** to move the cursor upwards, the cursor will move to the bottom when it reaches the top. If only one module is connected, pressing **E** will have no effect.

Press **V/A** to select the module and enter the I/O module data selection mode.

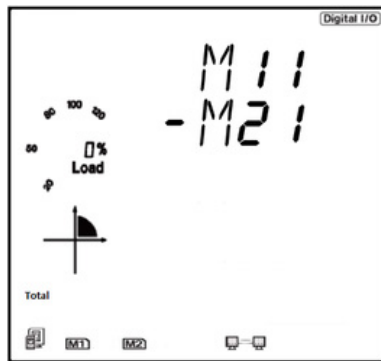

Figure 3-24 - Module Selection Screen

As shown in the figure, two modules are connected, AXM-IO11, AXM-IO21 which are indicated by M11, and M21, respectively. The cursor in the figure points to M21. The following table lists all I/O modules and codes they are associated with.

Table 3-3 I/O Module Representation

Code	Module
M11	AXM-IO1-1
M12	AXM-IO1-2
M21	AXM-IO2-1
M22	AXM-IO2-2
M31	AXM-IO3-1
M32	AXM-IO3-2

I/O Module Data Display

In the I/O Module Data selection screen, press **P** to move the cursor downwards; the cursor will move to the top when it reaches the bottom. Please note that there are 3 parameters for the AXM-IO1, 3 parameters for the AXM-IO2, and 4 parameters for the AXM-IO3.

Press **E** to move the cursor upwards; the cursor will move to the bottom when it reaches the top.

Press **V/A** to select the parameter and enter the display of the data.

Press **H** to return to the module selection screen.

The following figures display the screen sequence for each I/O module supported on the Acuvim II.

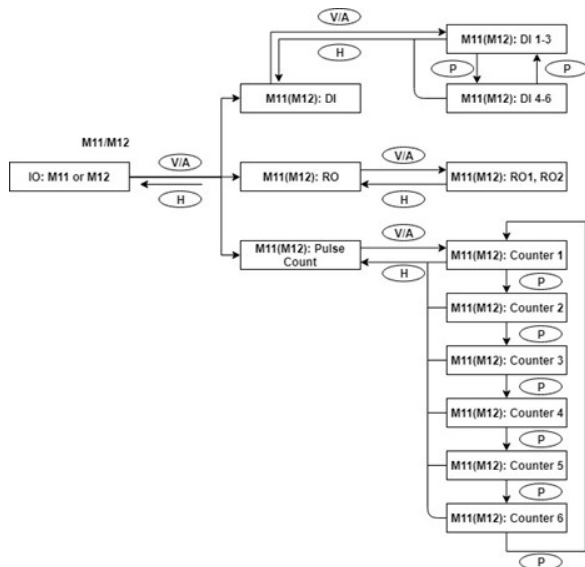

Figure 3-25 - AXM-IO1 data display screen sequence

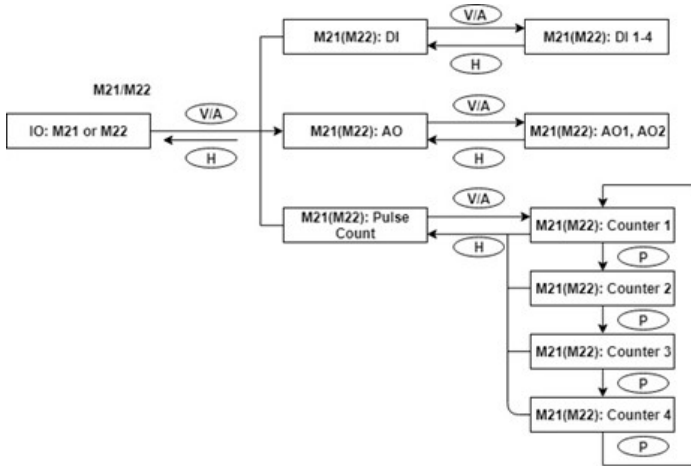

Figure 3-26 - AXM-IO2 data display screen sequence

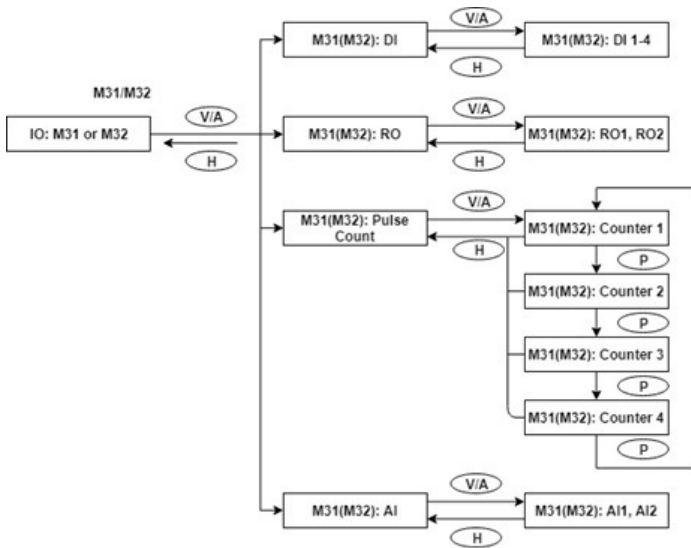

Figure 3-27 - AXM-IO3 data display screen sequence

3.7 Meter Setting Mode

In the settings mode, the system parameters, expanded I/O module parameters, alarm parameters, and communications module parameters can be read and modified. To access the settings mode, press **H** and **V/A** simultaneously for about one second then release; the screen will go blank, and the cursor will begin flashing. Press either **P** or **E** to move the flashing cursor over to **Setting** and press **V/A** to enter the meter settings.

3.7.1 Password Inquiry

In order to access the meter's settings, the meter's password must be entered. By default, the meter password is **0000**. The following figure shows the password screen.



Figure 3-28 - Password Inquiry Page

To enter a password:

- Press **H** to move the flashing cursor to the next position.
- Press **P** to increase the number by 1.
- Press **E** to decrease the number by 1.
- Press **V/A** to confirm the password.

NOTE: If the meter's password is unknown or forgotten, please contact Accuenergy Technical Support.

3.7.2 Parameter Selection Mode

Once the password has been entered correctly, there are four options to choose from in the parameter selection mode:

- System

- I/O
- NET (Depending on the type of communications module and protocol selected, this may say MESH or BACNET)
- Alarm

To navigate in the parameter selection mode, press **P** to move the cursor downwards; the cursor will move to the top when it reaches the bottom. Press **E** to move the cursor upwards; the cursor will move to the bottom when it reaches the top. Press **V/A** to select and enter the setting.



Figure 3-29 - Parameter Selection Page

3.7.3 System Settings

Users can select and modify system parameters in the system parameter setting mode.

Key functions for selecting a parameter:

- Pressing **P** will roll to the next screen and will return to the first page when **P** is pressed at the last page.
- The screen will roll to the last page each time **E** is pressed and will return to the last page when **E** is pressed at the first page.
- Press **V/A** to modify the selected parameter.
- Press **H** to return to the parameter selection mode.

Key functions for modifying the parameter:

- Press **H** to move the flashing cursor to the next position.
- Press **P** to increase the number by 1.
- Press **E** to decrease the number by 1.
- Press **V/A** to confirm the modification and return to parameter selection mode.

Figure 3-30 - System Parameters page sequence

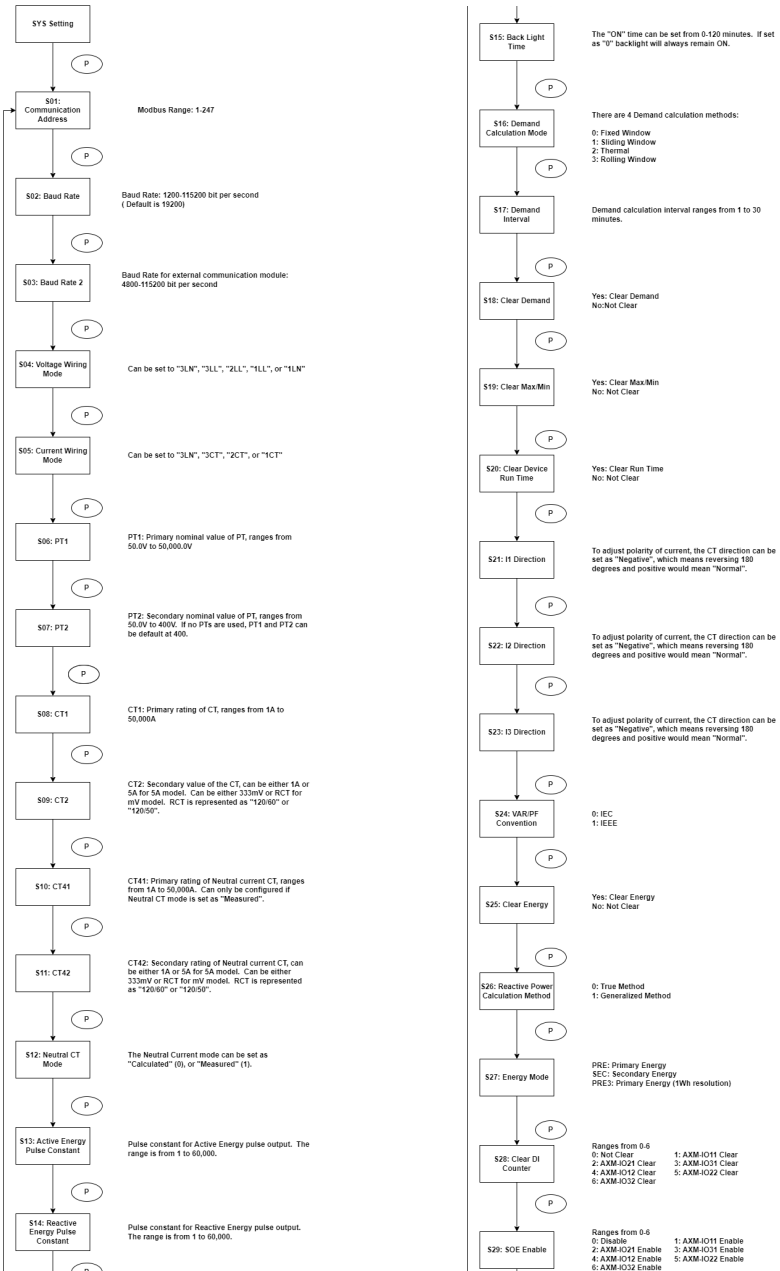

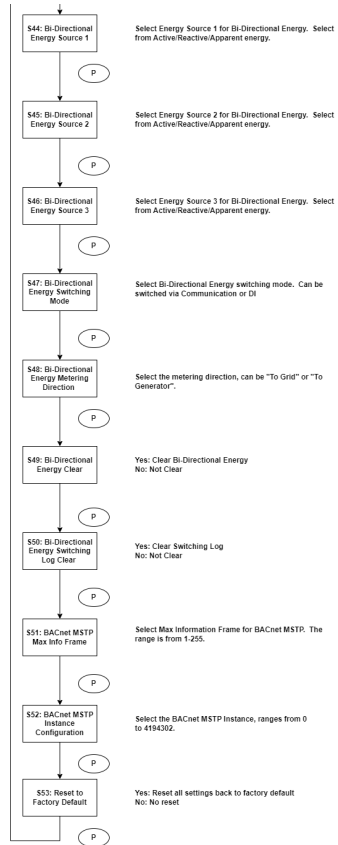
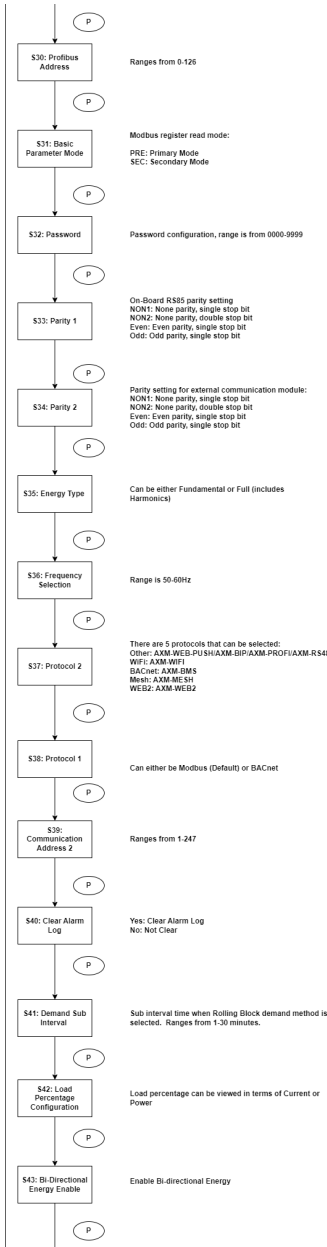

3.7.4 I/O Module Settings

In the expanded I/O module parameter mode, users can choose to view the available modules that are attached to the meter and modify their parameters. If no expanded I/O modules are connected, the screen will display **NO IO**. To return to the system parameter setting menu, press **H**.

Key functions for I/O module selection:

- Press **H** to return to parameter selection mode.
- Press **P** to move the cursor downwards. The cursor will move to the top when it reaches the bottom. If there is only one module connected, pressing **P** will have no effect.
- Press **E** to move the cursor upwards, the cursor will move to the bottom when it reaches the top. If there is only one module connected, pressing **E** will have no effect.
- Press **V/A** to select the module and enter the I/O module parameter setting mode.

Key functions for modifying the parameter:

- Press **H** to move the flashing cursor to the next position.
- Press **P** to increase the number by 1.
- Press **E** to decrease the number by 1.
- Press **V/A** to confirm the modification and return to parameter selection mode.

NOTE: Figures 3-30 to 3-33 show the rolling sequence using the P key. If you are using the E key for scrolling across the pages, the sequence will be reversed.

The following figures show the sequence for the I/O module settings:

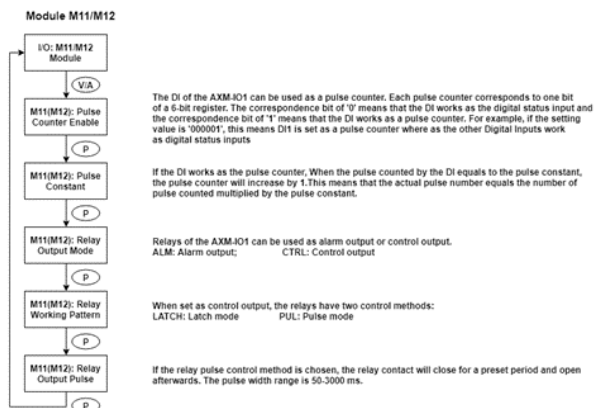

Figure 3-31 - Screen sequence for AXM-IO11/IO12

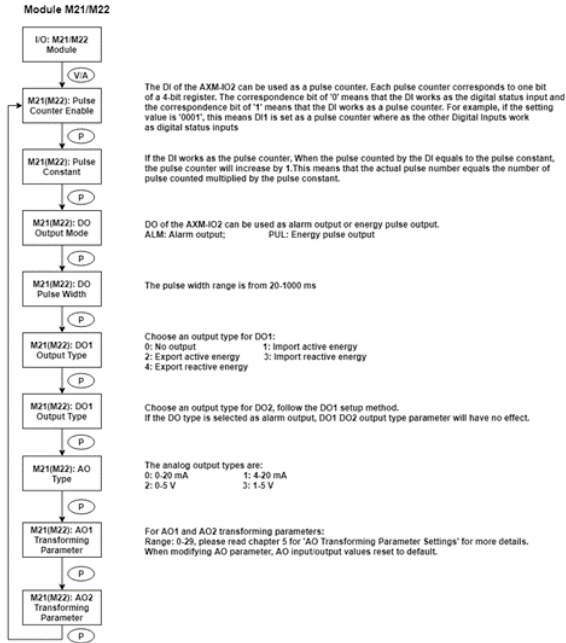

Figure 3-32 - Screen sequence for AXM-IO21/IO22

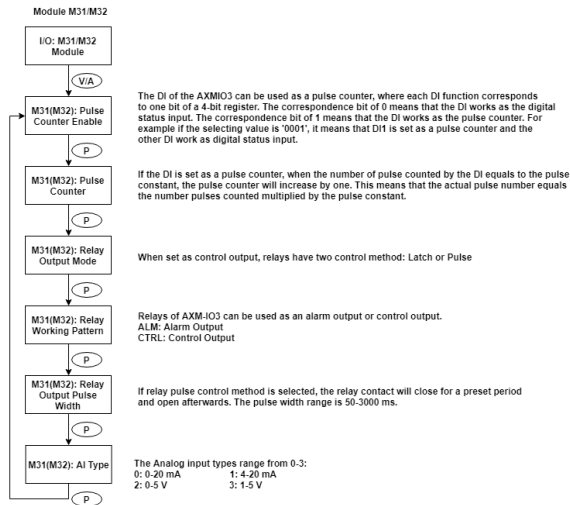

Figure 3-33 - Screen sequence for AXM-IO31/IO32

3.7.5 Communications Module Settings

When the second communication protocol is set to **BACnet**, there are certain pages that will be displayed related to BACnet. These pages will only be shown when the module is successfully connected to the meter; if the meter does not detect any module, it will display a **LOADING** page.

When the second communication protocol is set to **MESH**, the meter will display parameters related to the AXM-MESH module.

When the second communication protocol is set to **OTHER**, there will be parameters displayed related to the AXM-WEB-PUSH module.

When the second communication protocol is set to **WIFI**, there will be parameters displayed related to the AXM-WIFI module.

When the second communication protocol is set to **WEB2**, there will be parameters displayed related to the AXM-WEB2 module.

Key functions for finding the IO module parameters:

- Press **H** to return to parameter selection mode.
- The screen will roll to the next page each time **P** is pressed and will return to the first page when **P** is pressed on the last page.
- The screen will roll to the last page each time **E** is pressed and will return to the last page when **E** is pressed at the first page.
- Press **V/A** to modify the selected parameter.

Key functions for modifying the module parameters:

- Press **H** to move the flashing cursor to the next position.
- Press **P** to increase the number by 1.
- Press **E** to decrease the number by 1.
- Press **V/A** to confirm the modification and return to parameter selection mode.

The following figures show the screen sequence for the supported communication protocols:

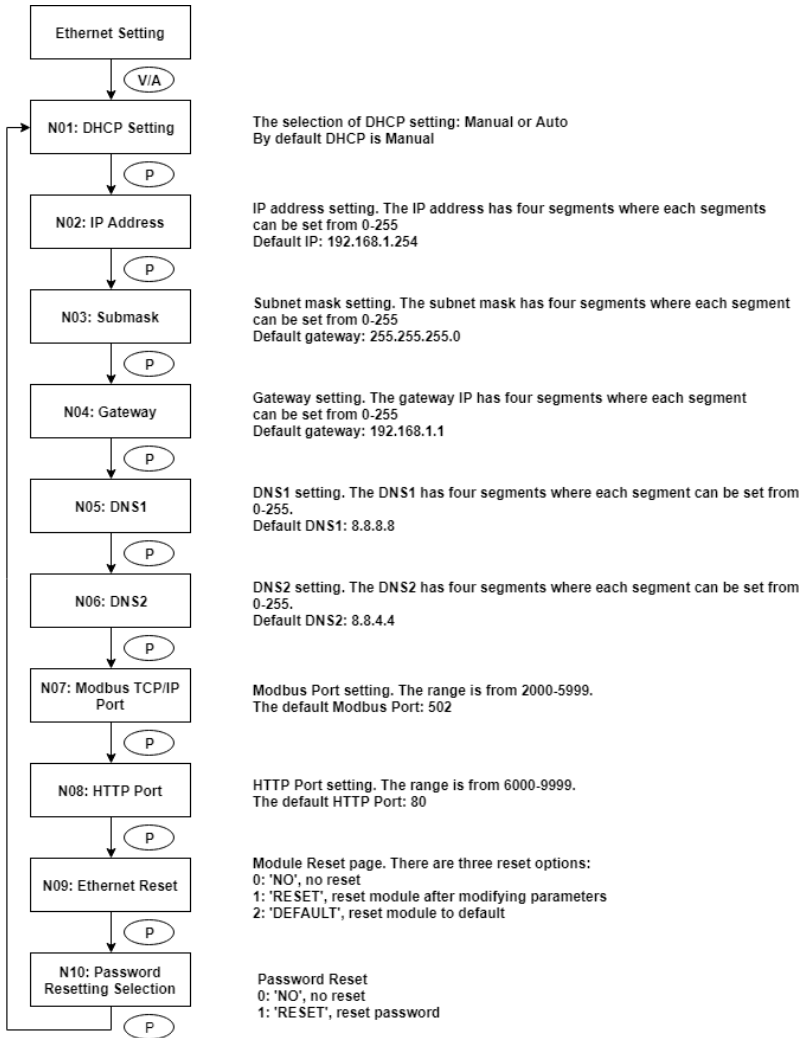

Figure 3-34 - Ethernet module net settings screen sequence

NOTE: This figure shows the rolling screen sequence using the P key. If using the E key for rolling to the next page the sequence will be reversed.

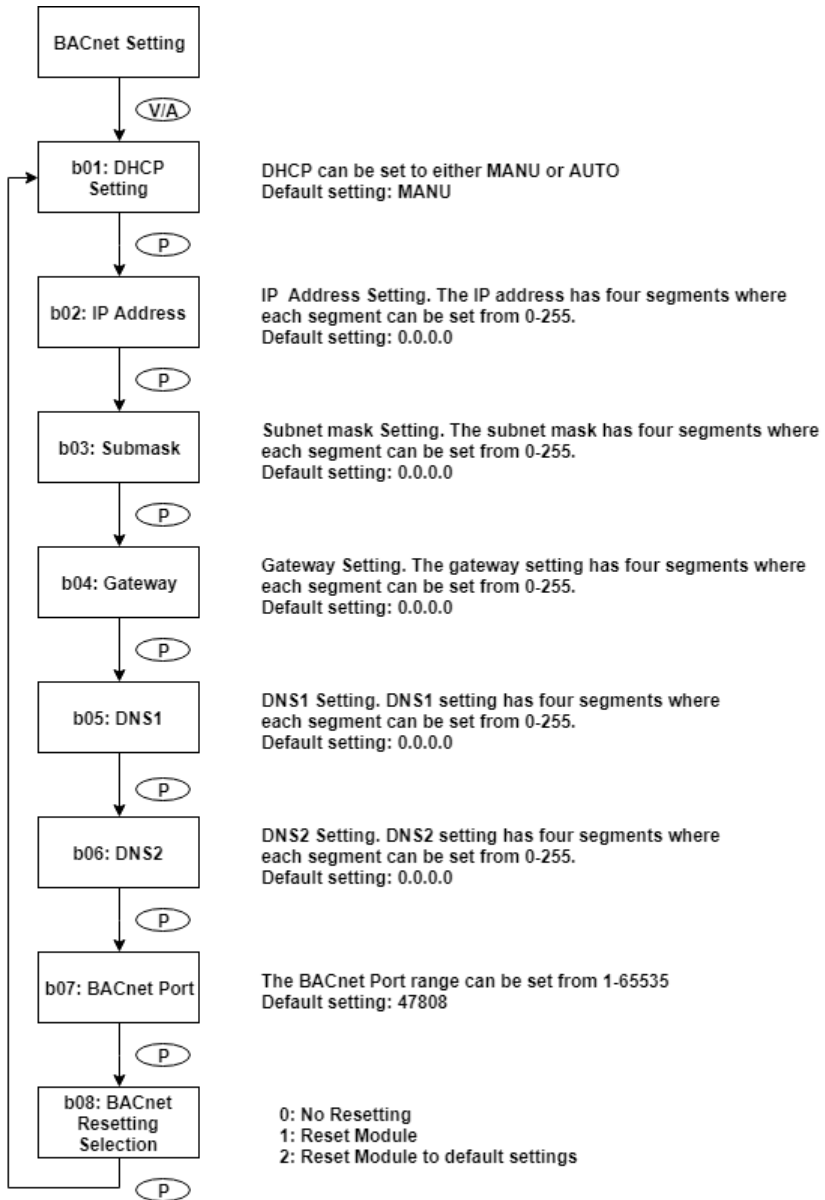

Figure 3-35 - BACnet IP module rolling screen sequence

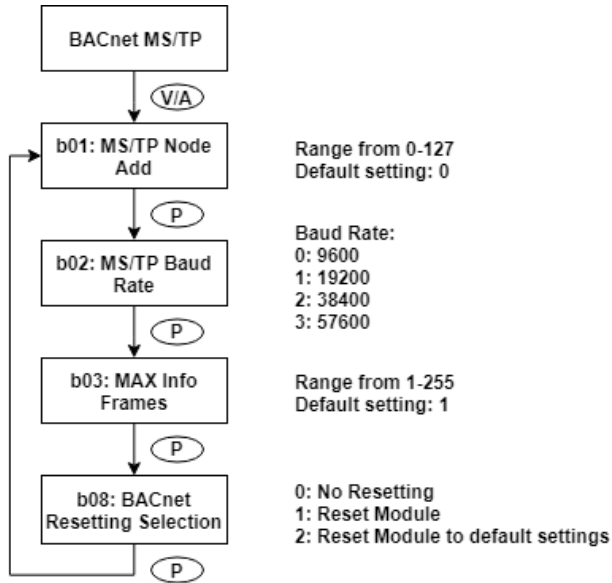

Figure 3-36 - BACnet MS/TP settings

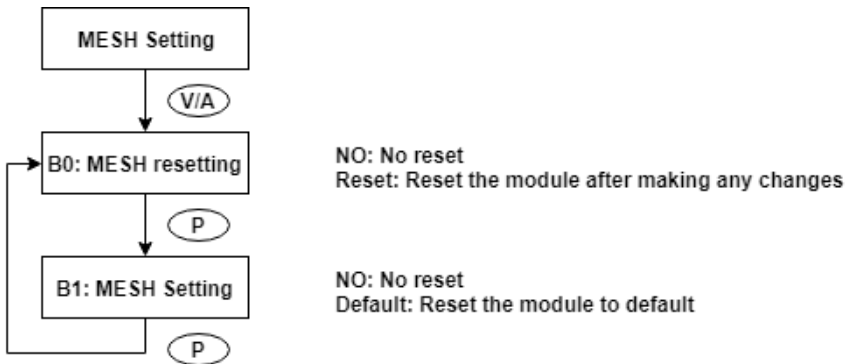

Figure 3-37 - Mesh settings

3.7.6 Alarm Settings

In the alarm parameter mode, the user can view and modify the parameters.

Key functions for finding the alarm parameter:

- Press **H** to return to parameter selection mode.
- The screen will roll to the next page each time **P** is pressed and will return to the first page when **P** is pressed on the last page.
- The screen will roll to the last page each time **E** is pressed and will return to the last page when **E** is pressed at the first page.
- Press **V/A** to modify the selected parameter.

Key functions for modifying the parameter:

- Press **H** to move the flashing cursor to the next position.
- Press **P** to increase the number by 1.
- Press **E** to decrease the number by 1.
- Press **V/A** to confirm the modification and return to parameter selection mode.

The following figure shows the sequence:

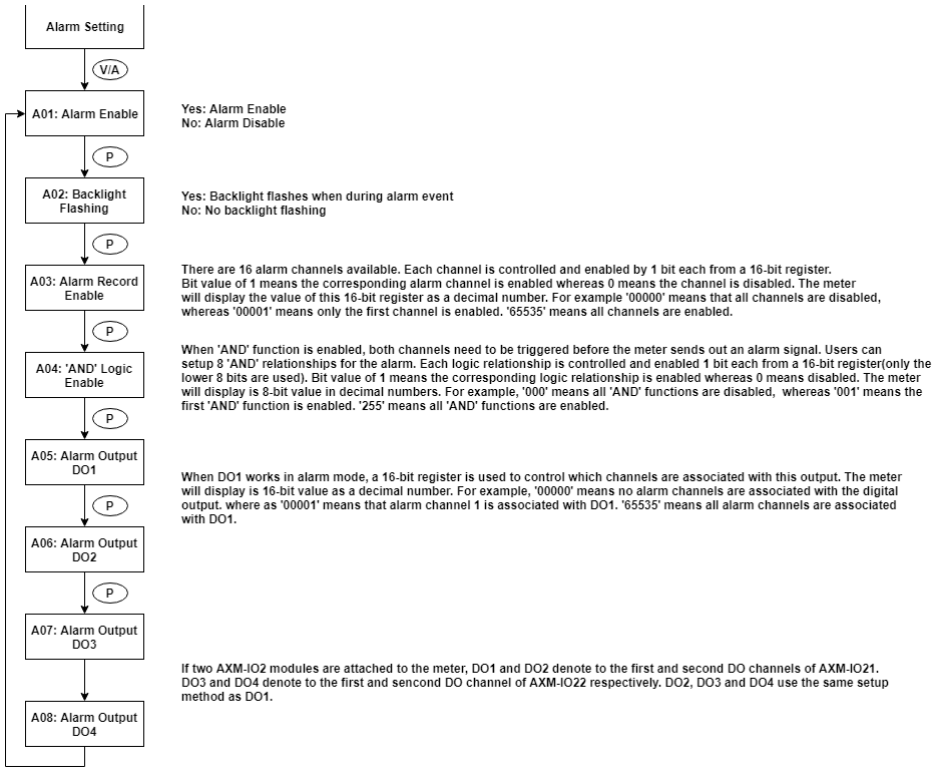

3.8 Page Recovery Function

The Acuvim II series meter includes a page recovery function. This means that the meter stores the current display page in the non-volatile memory upon power loss and reloads the page when power is recovered. If power goes off when viewing under the parameter setting mode, the meter will show voltage displayed when the power is recovered. If power goes off when viewing under the expanded I/O module data mode, and if this expanded I/O module is not connected when power recovers, the meter will show the voltage display page instead.

Chapter 4: Detailed Functions and Software

The Acuvim II series meter contains advanced metering tools and is able to measure a multitude of power, energy and power quality parameters. Some advanced functions may not be accessible directly from the meter front; therefore, every meter can connect to our Acuvim software that helps to access the information. This chapter introduces these functions and software.

4.1 Acuvim Software

The Acuvim software is a free data logging software that can be used to read the meters data, as well as configure and view settings. This software is free to download from our website (www.accuenergy.com).

The software uses the Modbus protocol to communicate with the meter. Users can connect to the software via the built in RS485 communication port or by Modbus TCP via communications module.

4.1.1 Connect using RS485

Using the meters RS485 communication port users can connect to the software using an RS485 to USB converter. The RS485 port on the meter has three terminals where 14 is labeled A (positive), terminal 15 is B (negative), and terminal 16 is S (Shield). The communication port uses half-duplex two wire RS485 communication where the data is passed in one direction at a time, and the send (TX) and receive (RX) signals are shared between the two wires.

The figure below depicts how the RS485-USB converter should be wired into the meter, the T/R+ on the converter connected to terminal 14(A) on the Acuvim II meter, and T/R- on the converter connected to terminal 15(B) on the meter.

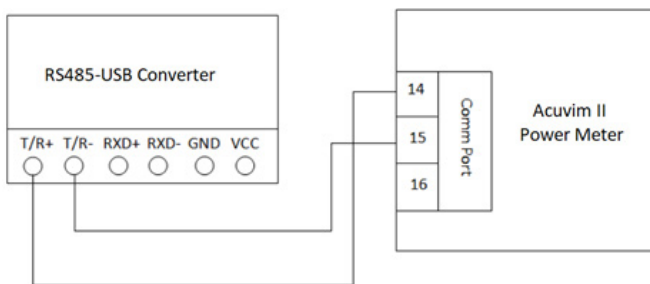

Figure 4-1 - RS485-USB converter connection to Acuvim II meter

Acuvim II Series Power Meter

Once the physical wiring is connected between the converter cable and the Acuvim II meter, the meter's communication settings need to be confirmed. The communication settings in this case are the meter's Modbus device address (slave ID), the communication speed or baud rate, and the parity. By default, the meter has the following communication settings:

- **Modbus Device Address:** 1
- **Baud Rate:** 19200
- **Parity:** Non1 (no parity, 1 stop bit)

NOTE: *If users are connecting to a meter with no display (DIN rail mount model), please note that the default baud rate of the meter is 9600 when the meter is first powered up. After one minute of being powered, the default baud rate changes to 19200.*

Next, the COM port must be confirmed for the computer that is being used to connect to the meter. To determine the COM port that is assigned, open the Device Manager on the computer. Under the **Port (COM & LPT)** heading, find the COM port number; for example, in the figure below, COM4 has been assigned to the RS485-USB converter. Note the COM port number as it is required to connect to the software.

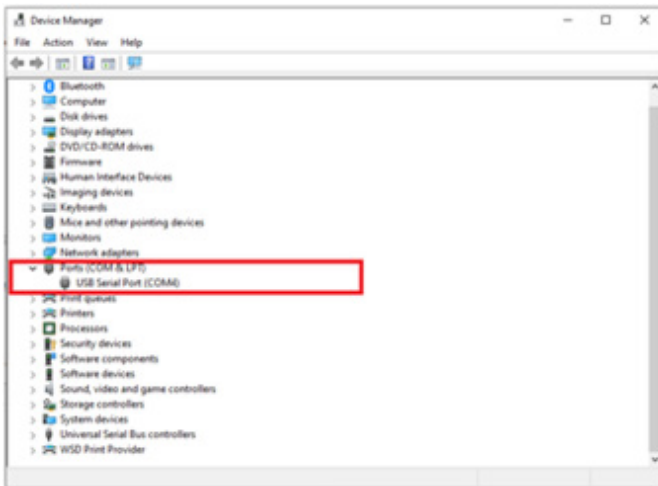

Figure 4-2 - COM port number assigned to USB converter

Open the **Acuview** software. The following New Connection screen will appear where users are required to provide the type of connection, COM port, baud rate, parity, and scan interval.

Select the connection type as **Serial Port** and then select the COM port number assigned to the USB converter cable from the device manager.

Next, enter in the communication settings (Baud Rate, Parity) from the Acuim II meter into the software. The scan interval can be left as the default of 200ms. Click **OK** after all settings have been entered.

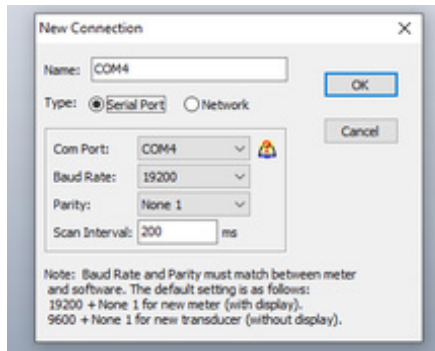

Figure 4-3 - Creating new connection on the Acuview software

Next, the device will need to be added to the software where users will need to enter in the device type, the connection, device address, and a description for the device.

For the device type, users can select the Acuim II meter model they are using (Acuim IIR, Acuim IIW). The connection would be referring to the connection that was created in the step above in Figure 4-3. The device address is in reference to the Modbus device address from the Acuim II meter, and the description field is used for labeling the device in the software.

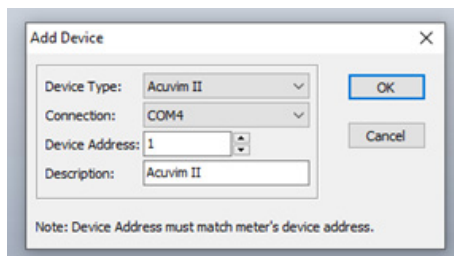

Figure 4-4 - Adding Acuim II device to the software

After clicking **OK**, the meter should automatically connect to the software, and you should see data appear on the main screen in Acuview. If the meter does not initially connect, click on the **Operation** menu and select **Connect**.

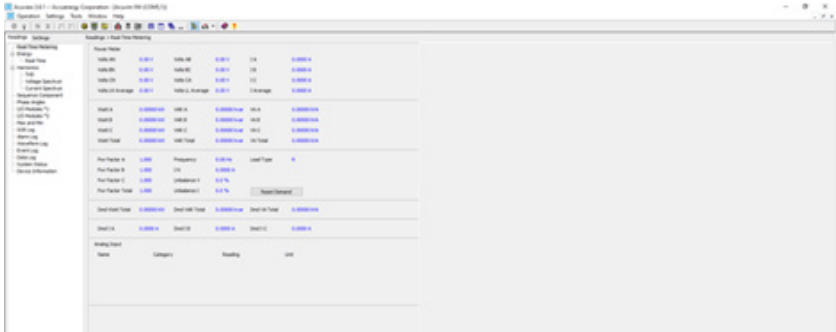

Figure 4-5 - Acuvim Software interface once successfully connected to the meter

NOTE: For methods on how to connect to the software using Modbus TCP via a communications module, please refer to the AXM-WEB2 or AXM-WEB-PUSH User Manual which can be found on our website: www.accuenergy.com.

4.2 Basic Analog Measurements

The Acuvim software allows users to view all real-time analog measurements with high accuracy. The real-time parameters that the meter can measure include voltage, current, power, frequency, power factor, demand, etc.

Readings > Real-Time Metering					
Power Meter					
Volts AN	131.44 V	Volts AB	207.64 V	I A	19.745 A
Volts BN	128.92 V	Volts BC	207.64 V	I B	20.392 A
Volts CN	101.82 V	Volts CA	207.57 V	I C	19.224 A
Volts LN Average	120.73 V	Volts LL Average	207.62 V	I Average	19.787 A
Watt A	2.56515 kW	VAR A	-0.38674 kvar	VA A	2.59626 kVA
Watt B	2.60608 kW	VAR B	0.32843 kvar	VA B	2.62855 kVA
Watt C	1.94880 kW	VAR C	-0.14413 kvar	VA C	1.95827 kVA
Watt Total	7.12003 kW	VAR Total	-0.20245 kvar	VA Total	7.18308 kVA
Pwr Factor A	0.988	Frequency	49.88 Hz	Load Type	C
Pwr Factor B	0.991	I N	0.0000 A		
Pwr Factor C	0.995	Unbalance V	0.0 %		
Pwr Factor Total	0.991	Unbalance I	0.0 %	<input type="button" value="Reset Demand"/>	
Dmd Watt Total	7.12145 kW	Dmd VAR Total	-0.19630 kvar	Dmd VA Total	7.18718 kVA
Dmd I A	19.755 A	Dmd I B	20.380 A	Dmd I C	19.217 A
Analog Input					
Name	Category	Reading	Unit		

Fig 4-6 - Real-Time Metering

4.2.1 High Speed Monitoring

The Acuvim II V3 model supports High Speed Monitoring which includes either 100ms or 20ms sampling rates.

The high speed parameters include most real time parameters for 100ms, however at 20ms sampling the meter only supports voltage, current, total active/reactive power and frequency.

The following images show the parameters for both 100ms and 20ms:

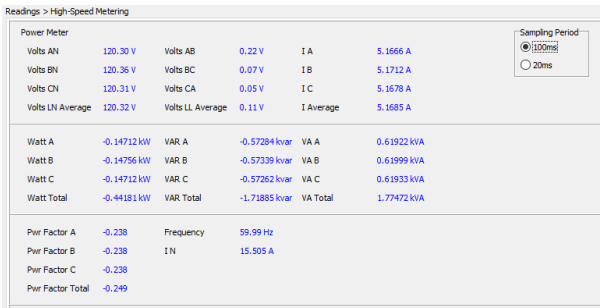

Fig 4-6-1a - 100ms High Speed Monitoring

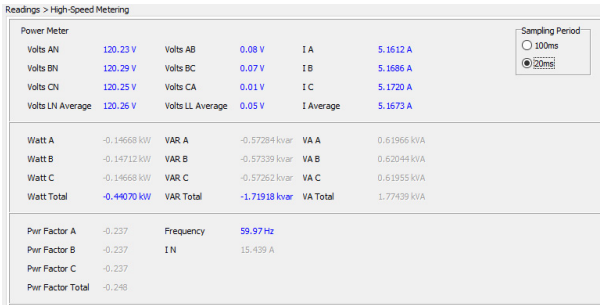

Fig 4-6-1b - 20ms High Speed Monitoring

4.3 Demand

This meter can support demand measurements consisting of power and current demand readings. The demand can be found in the real-time section as outlined in Figure 4-7 below.

The demand will be calculated using the demand calculation method configured in the meter. The calculation types include:

- **Fixed Window:** The demand is calculated based on selecting the calculation period between 1-30 minutes. The meter will calculate and update the demand values at the end of each calculation period.
- **Sliding Window:** The demand is calculated by selecting the calculation period between 1-30 minutes. The meter will average the energy accumulated within this period of time and the demand value is updated every minute.
- **Thermal:** The demand is calculated based on thermal response, used in thermal demand meters. This method uses a sliding window to update the demand value at the end of each calculation period.
- **Rolling Window:** The demand is based on selecting a calculation period between 1-30 minutes, a sub interval (Demand Calculation Slip Time), and the demand value is updated at each sub interval. The sub interval must be a factor of the calculation period. For example, with a calculation period of 15 minutes, the sub interval can be configured as 5 minutes.

The demand calculation type and interval can be configured in the meter settings on either the software, which will be discussed in the software settings portion of this chapter, or from the front display of the meter (refer to Chapter 3 for accessing the demand settings).

Readings > Real-Time Metering

Power Meter					
Volts AN	131.44 V	Volts AB	207.64 V	I A	19.745 A
Volts BN	128.92 V	Volts BC	207.64 V	I B	20.392 A
Volts CN	101.82 V	Volts CA	207.57 V	I C	19.224 A
Volts LN Average	120.73 V	Volts LL Average	207.62 V	I Average	19.787 A
Watt A	2.56515 kW	VAR A	-0.38674 kvar	VA A	2.59626 kVA
Watt B	2.60608 kW	VAR B	0.32843 kvar	VA B	2.62855 kVA
Watt C	1.94880 kW	VAR C	-0.14413 kvar	VA C	1.95827 kVA
Watt Total	7.12003 kW	VAR Total	-0.20245 kvar	VA Total	7.18308 kVA
Pwr Factor A	0.988	Frequency	49.88 Hz	Load Type	C
Pwr Factor B	0.991	I N	0.0000 A		
Pwr Factor C	0.995	Unbalance V	0.0 %		
Pwr Factor Total	0.991	Unbalance I	0.0 %	<input type="button" value="Reset Demand"/>	
Dmd Watt Total	7.12145 kW	Dmd VAR Total	-0.19630 kvar	Dmd VA Total	7.18718 kVA
Dmd I A	19.755 A	Dmd I B	20.380 A	Dmd I C	19.217 A
Analog Input					
Name	Category	Reading	Unit		

Figure 4-7 - Demand Readings

4.4 Energy

The Acuvim II meter supports the writing of energy values which can be done via software or Modbus but not from the meter's display. This is used to configure the meter to start accumulating from a certain energy value.

Energy Calculating mode

1. Users can select different energy calculating modes, fundamental based or full-wave based either from the meter-front or via communication. The fundamental based calculating is used to accumulate energy without taking harmonics into consideration while full-wave based calculating is used to accumulate energy including fundamentals and harmonics.

NOTE: When fundamental based calculating mode is selected, the PF calculation will be based on the fundamental wave.

NOTE: If user has 400Hz Acuvim II model, only the full-wave method is supported.

2. The energy reading can be set as either Primary or Secondary. Primary displays the energy accumulation in terms of the Primary measurement and Secondary will display the energy accumulation in terms of the secondary measurement with resolution of up to 1Wh. Users can configure this setting by either by pressing keys from the meter-front (refer to chapter 3), via Modbus communication though Acuvim software, or through Modbus registers.

NOTE: Acuvim II is able to display either primary energy or secondary energy on the LCD screen. However, it is only able to send out pulses according to secondary energy via the AXM-I/O module.

Readings > Energy > Real-Time					
Power Meter					
Ep_imp	20497.7 kWh	Eq_imp	20766.2 kvarh		
Ep_exp	15258.9 kWh	Eq_exp	27981.6 kvarh		
Ep_total	35756.6 kWh	Eq_total	48747.8 kvarh		
Ep_net	5238.8 kWh	Eq_net	-7215.4 kvarh		
Es	60653.9 kWh				
<input type="button" value="Reset Energy"/>					
Ep_imp_a	0.0 kWh	Eq_imp_a	195.7 kvarh	Es_a	242.6 kWh
Ep_imp_b	0.0 kWh	Eq_imp_b	196.3 kvarh	Es_b	243.4 kWh
Ep_imp_c	0.0 kWh	Eq_imp_c	196.3 kvarh	Es_c	243.4 kWh
Ep_exp_a	141.0 kWh	Eq_exp_a	0.0 kvarh		
Ep_exp_b	141.3 kWh	Eq_exp_b	0.0 kvarh		
Ep_exp_c	141.2 kWh	Eq_exp_c	0.0 kvarh		

Figure 4-8 - Energy Readings

4.5 Max/Min

Acuvim II series meter logs maximum and minimum value statistics for all real time, demand, THD parameters and also log the time that it occurred. All data is stored in non-volatile memory so that statistic information can be preserved even when the meter is loses power or gets shut off. All maximum and minimum data can be accessed via communication or from the meter front, however only timestamps information can only be accessed via communication.

Statistical data can be cleared via communication or from the meter-front.

Readings > Max and Min

Channel	Maximum	Time Stamp	Minimum	Time Stamp
Volts AN	399.9 V	2019-08-14 07:16:09	0.0 V	2017-06-29 07:40:13
Volts BN	129.6 V	2017-11-16 09:21:51	0.0 V	2017-06-29 07:40:13
Volts CN	129.3 V	2017-11-16 09:21:51	0.0 V	2017-06-29 07:40:13
Volts AB	121.1 V	2017-08-25 00:22:16	0.0 V	2017-02-16 07:31:46
Volts BC	120.8 V	2017-08-25 00:22:16	0.0 V	2017-02-16 07:31:46
Volts CA	62.4 V	2018-08-30 13:22:56	0.0 V	2017-02-16 07:31:46
I A	99.96 A	2019-07-10 21:51:45	0.000 A	2017-05-04 15:14:47
I B	9.600 A	2018-12-04 20:05:51	0.000 A	2017-05-04 15:14:47
I C	9.600 A	2018-12-04 20:05:51	0.000 A	2017-05-04 15:14:47
Watt Total	7.960 kW	2019-08-14 07:07:54	-1.400 kW	2017-06-22 10:35:32
VAR Total	0.600 kvar	2017-06-22 10:35:32	-0.840 kvar	2017-02-23 07:32:09
VA Total	7.960 kVA	2019-08-14 07:07:54	0.000 kVA	2017-02-23 07:31:55
Pwr Factor Total	1.000	2017-02-23 07:31:55	-1.000	2018-10-25 09:54:42
Frequency	64.44 Hz	2018-12-21 10:31:09	0.00 Hz	2017-02-23 07:31:55
Watt Total (Demand)	7.960 kW	2019-08-14 07:22:45	-1.080 kW	2018-09-24 13:32:00
VAR Total (Demand)	0.400 kvar	2018-09-25 06:51:17	-0.720 kvar	2017-03-22 03:30:25
VA Total (Demand)	7.960 kVA	2019-08-14 07:22:45	0.000 kVA	2017-02-16 07:31:46
Unbalance V	100 %	2017-08-25 00:21:59	0.0 %	2017-02-16 07:31:46
Unbalance I	99.5 %	2018-09-24 11:15:25	0.0 %	2017-02-16 07:31:46
THD Volts AN/AB	40.93 %	2019-08-14 07:06:30	0.00 %	2017-02-23 07:31:55
THD Volts BN/CA	12.47 %	2018-08-29 11:37:35	0.00 %	2017-02-23 07:31:55
THD Volts CN/BC	12.40 %	2018-08-29 11:37:35	0.00 %	2017-02-23 07:31:55
THD I A	210.38 %	2018-11-28 19:16:36	0.00 %	2017-02-23 07:31:55
THD I B	211.41 %	2018-11-28 19:16:36	0.00 %	2017-02-23 07:31:55

Reset Max and Min Save

Figure 4-9 Max and Min readings

4.6 Harmonics and Power Quality Analysis

4.6.1 Harmonics & THD

Acuvim II series meter can measure and analyze several power quality parameters which is useful for further analyzing the voltage and current signals measured by the meter.

Total Harmonic Distortion: A ratio of the sum of powers in all harmonic components to power of the fundamental frequency. The Acuvim II meter also supports even and odd order THD, where even order harmonics are the 2nd, 4th, 6th, and so on and odd order harmonics are 3rd, 5th, 7th, etc.

Crest Factor: Is the ratio between either the peak current or voltage and the RMS value.

THFF: Stands for Telephone Harmonic Form Factor and is the ratio of the square root of the sum of the squares for all the sine wave components (including alternating current waves both fundamental and harmonic) to the RMS value of the entire wave form.

K Factor: A measure of the heating effect caused by current harmonics that helps determine the linearity of a load. If the K factor is 1, this means that the load is linear and that there are no harmonics present. However, a K factor value greater than one means that the load is not linear and that there is a higher heating effect caused by the harmonics in the system.

Harmonics are essentially high frequency waveforms that are combined with or superimposed over the fundamental frequency. The fundamental frequency is the circuit frequency which is 50 or 60Hz depending on the system that is being monitored. The Acuvim II meter supports individual voltage and current harmonics up to the 63rd order. This means that the meter can monitor the percentage of harmonics present up to the 63rd order (63 times the fundamental frequency). This provides users with an in depth examination of the power quality for the system they are monitoring.

NOTE: The 400 Hz Acuvim II model only supports 2nd~15th harmonics.

Readings > Harmonics > THD					
THD Volts AN/AB	25.08 %	THD I A	0.00 %		
THD Volts BN/CA	23.21 %	THD I B	0.00 %		
THD Volts CN/BC	20.56 %	THD I C	0.00 %		
THD Volts Average	22.95 %	THD I Average	0.00 %		
Odd THD V A	14.61 %	Odd THD V B	15.62 %	Odd THD V C	12.96 %
Even THD V A	20.31 %	Even THD V B	17.18 %	Even THD V C	15.95 %
THFF V A	25.38 %	THFF V B	23.48 %	THFF V C	24.05 %
Crest Factor V A	2.963	Crest Factor V B	2.965	Crest Factor V C	2.680
Odd THD I A	0.00 %	Odd THD I B	0.00 %	Odd THD I C	0.00 %
Even THD I A	0.00 %	Even THD I B	0.00 %	Even THD I C	0.00 %
K Factor I A	0.0	K Factor I B	0.0	K Factor I C	0.0

Figure 4-10 - THD Reading

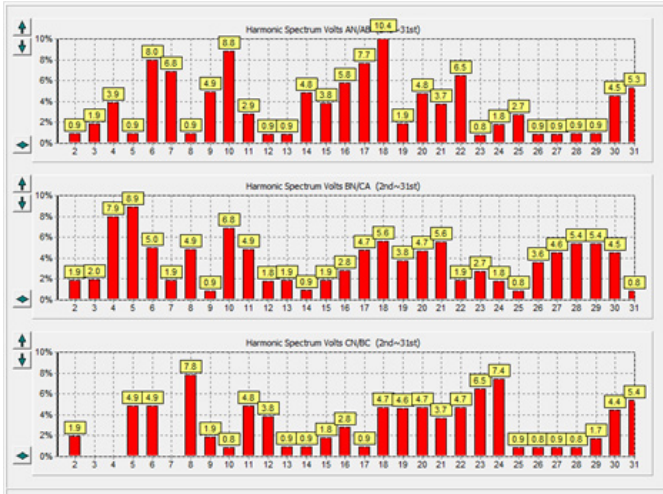

Figure 4-11 - Individual Harmonic Reading

4.6.2 Amplitude and Angle

This section provides users with the amplitude and phase angle details of the harmonics being measured by the meter. For example if the voltage input to the meter is 120V, and a harmonic reading of 10% for the 2nd order, the amplitude in this case will show 12V. Both voltage harmonics and current harmonic amplitude/angles can be viewed. Users can view from the 2nd to 63rd order by using the scroll bar on the software.

Readings > Harmonics > THD

THD Volts AN/AB	25.08 %	THD I A	0.00 %
THD Volts BN/CA	23.21 %	THD I B	0.00 %
THD Volts CN/BC	20.56 %	THD I C	0.00 %
THD Volts Average	22.95 %	THD I Average	0.00 %

Odd THD V A	14.61 %	Odd THD V B	15.62 %	Odd THD V C	12.96 %
Even THD V A	20.31 %	Even THD V B	17.18 %	Even THD V C	15.95 %
THFF V A	25.38 %	THFF V B	23.48 %	THFF V C	24.05 %
Crest Factor V A	2.963	Crest Factor V B	2.965	Crest Factor V C	2.680

Odd THD I A	0.00 %	Odd THD I B	0.00 %	Odd THD I C	0.00 %
Even THD I A	0.00 %	Even THD I B	0.00 %	Even THD I C	0.00 %
K Factor I A	0.0	K Factor I B	0.0	K Factor I C	0.0

Figure 4-11-a - Amplitude and Angle Section

4.6.3 Phase Angles

Phase angle indicates the angle between phase A voltage and other voltage/current parameters in a range from 0 to 360 degrees. These readings allows the users to analyze the phase angle difference between each phase and also determine if current/voltage are incorrectly out of phase, which tend to be related to wiring/installation issues with the meter.

- When the wiring is set to 2LL or 3LL, the meter provides the phase angles of U23, U31, I1, I2, I3 corresponding to U12 (reference angle).
- When the wiring is set to 3LN, the phase angles are U2, U3, I1, I2, and I3 where U1 is the reference angle.
- When the wiring is set to 1LL, the meter has phase angle of U2, I1, and I2 where U1 is the reference angle.

The phase angle readings from Acuvue software are shown in Figure 4-12. The image provides the phase angle reading of a three-phase four wire system (3LN), where the three-phase voltage is 120 degrees apart. The current phase angle for three-phase four wire balanced systems is usually aligned with the voltage phase angles.

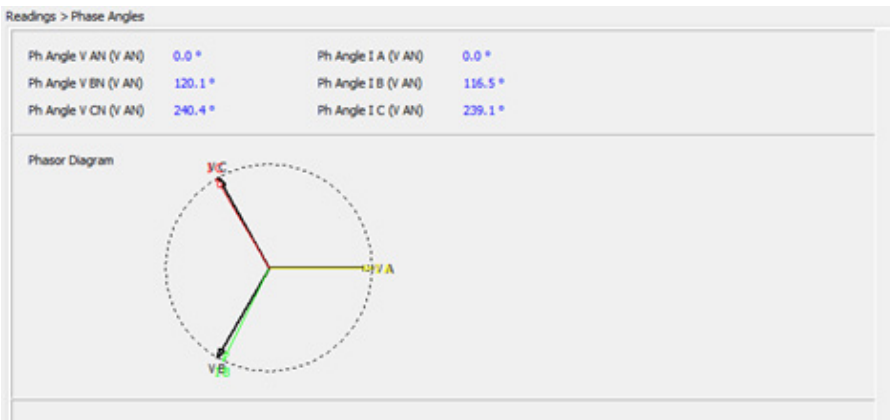

Figure 4-12 - Phase Angle Diagram & Readings

4.6.4 Sequence Component and Unbalance Analysis

Acuvim II series meter is able to perform sequential analysis for the input signal. The sequence components allow users to represent three-phase systems as individual into three single phase networks, where these networks can be described as the positive sequence, negative sequence and zero sequence.

Positive Sequence: Three phasors of the positive sequence are equal in magnitude and are spaced by 120 degrees.

$$I_0 = \frac{1}{3} * (I_a + aI_b + a^2I_c)$$

$$V_0 = \frac{1}{3} * (V_a + aV_b + a^2V_c)$$

$$a = 1\angle 120^\circ$$

$$a^2 = 1\angle 240^\circ$$

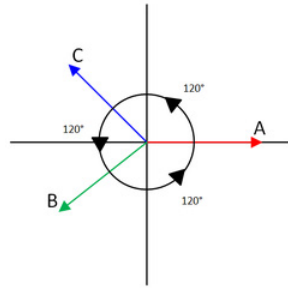

Figure 4-13 - Positive Sequence Phasor Diagram

Negative Sequence: Similar to the positive sequence, the negative phase-sequence phasors are of equal in magnitude and spaced by 120 degrees. The main difference between positive and negative sequence is the phase rotation, where the negative sequence has phase B phase leading phase A rather than lagging in the positive sequence.

$$I_1 = \frac{1}{3} * (I_a + a^2I_b + aI_c)$$

$$V_1 = \frac{1}{3} * (V_a + a^2V_b + aV_c)$$

$$a = 1\angle 120^\circ$$

$$a^2 = 1\angle 240^\circ$$

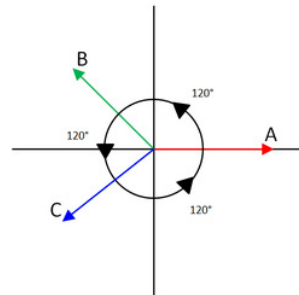

Figure 4-14 - Negative Sequence Phasor Diagram

Zero Sequence: Combines a set of three phasors that are equal in magnitude and in-phase with each other. Unlike the positive and negative sequence, there is no rotation associated with the zero sequence.

$$I_0 = \frac{1}{3} * (I_a + I_b + I_c)$$

$$V_0 = \frac{1}{3} * (V_a + V_b + V_c)$$

Figure 4-15 - Zero Sequence Phasor Diagram

Unbalance Factor

The unbalance factor allows users to understand the percentage in which the voltage and current are unbalanced. The factor is a percentage of the ratio of the negative/zero sequence component to the positive sequence component, and essentially tells users that the magnitude, as well as the phase angles, between of the three-phase voltage/current is not equal. Figure 4-16 shows the unbalance and sequence component reading from the Acuvue software.

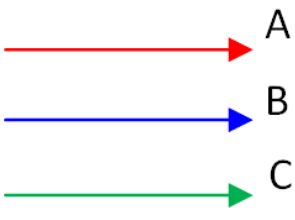
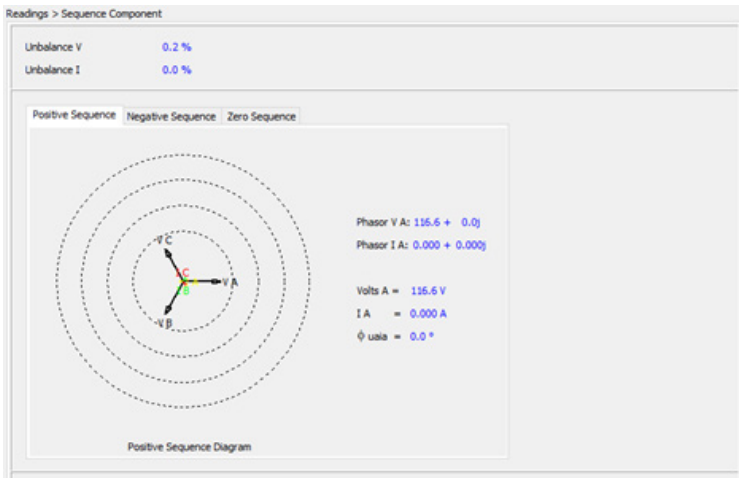

Figure 4-16 - Unbalance and Sequence Component Reading

4.7 Alarm

Acuvim II series meter supports an over/under limit alarming function. When the monitored parameter goes over or under the preset limit and stays at the level over the preset time delay, the alarm will be triggered. The alarm can be configured directly from the meter display, the Acuvim software, or via Modbus communication.

The meter can have a maximum of 16 alarm channels configured. If users have extended I/O modules attached, the alarms can trigger different functions, such as a relay output or digital output, which can be used to activate downstream devices such as a beacon light or buzzer. There is an option to have the meter's display flash when an alarm is triggered which provides users a visual cue that an alarm condition has been triggered.

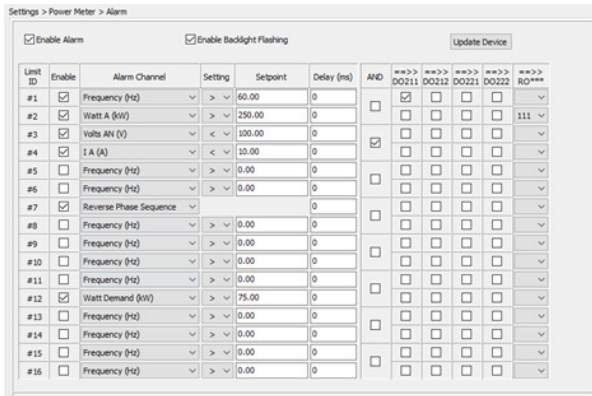

Figure 4-17 - Alarm Setting

Before using the alarming function, alarm conditions such as logic dependency, target set point, and time delay must be correctly set. Settings can be accessed and modified from the software via the communication connection as shown in Fig 4-17. To access the alarm settings from the meter display, refer to Chapter 3 for the screen sequence. To configure the alarms using Modbus, refer to Chapter 6 to view the register list.

Alarm Channel/Parameter Code: Users can select from the drop down menu the desired parameter to alarm in the alarm settings page. If setting the alarms using Modbus or from the meters display enter in the alarm code for the desired parameter, the alarm code table can be seen in table 4-3. For example, "0" would represent frequency and "17" would represent Total System Power.

Comparison Mode: Users can select three, different alarm conditions:

1. Greater than (>)
2. Equal to (=)
3. Smaller than (<)

For example: If you choose the target parameter to be "Frequency," the condition to be "greater than" and set point to be "50," the alarm will be triggered when the frequency is greater than 50Hz and will come out of the alarm condition when the frequency is less than 50Hz.

Setpoint: The setpoint is the parameter value used in the alarm condition and is the alarm condition value whether you want to trigger below, under, or when the parameter is equal to this setpoint value.

Delay Time: If the alarm condition lasts for the preset time period, the alarm signal will be triggered. The delay range is from 0 to 3000 (unit: 10ms). When it is set to 0, there is no delay and alarm will be triggered when the alarm condition is met. If it is set to 20, there will be a 200ms (20 x 10ms) delay.

Output to Digital Output: If using an AXM-IO2 module, users have the option to output a pulse signal when an alarm is triggered.

Table 4-1 - Digital Output Alarm Translation

DO Code	DO Channel	IO Module
DO211	DO1	AXM-IO2-1
DO212	DO2	AXM-IO2-1
DO221	DO1	AXM-IO2-2
DO222	DO2	AXM-IO2-2

Output to Relay: If using an AXM-IO1 or AXM-IO3 module, users have the option to send a signal to the relay output when an alarm is triggered. Select one of the following options in the RO drop-down menu:

Table 4-2 - Relay Output Alarm Translation

RO Code	RO Channel	IO Module
111	RO1	AXM-IO1-1
112	RO2	AXM-IO1-1

RO Code	RO Channel	IO Module
121	RO1	AXM-IO1-2
122	RO2	AXM-IO1-2
311	RO1	AXM-IO3-1
312	RO2	AXM-IO3-1
321	RO1	AXM-IO3-2
322	RO2	AXM-IO3-2

NOTE: If RO is under alarming mode, it can only work in the “latch” mode.

Table 4-3 - Alarming Parameter Code Table

Alarming Parameter Code	Alarming Parameter	Alarming Parameter Code	Alarming Parameter	Alarming Parameter Code	Alarming Parameter	Alarming Parameter Code	Alarming Parameter
0	Frequency	21	Total Reactive Power	42	Analog Input Channel 2 (AXM_IO3-1)	63	DI2 (AXM-IO3-1)
1	Phase A Voltage	22	Phase A Apparent Power	43	Analog Input Channel 1 (AXM-IO3-2)	64	DI3 (AXM-IO3-1)
2	Phase B Voltage	23	Phase B Apparent Power	44	Analog Input Channel 2 (AXM-IO3-2)	65	DI4 (AXM-IO3-1)
3	Phase C Voltage	24	Phase C Apparent Power	45	Active Power Demand	66	DI1 (AXM-IO1-2)
4	Average Phase Voltage	25	Total Apparent Power	46	Reactive Power Demand	67	DI2 (AXM-IO1-2)
5	Line Voltage AB	26	Phase A Power Factor	47	Apparent Power Demand	68	DI3 (AXM-IO1-2)
6	Line Voltage AC	27	Phase B Power Factor	48	Phase A Current Demand	69	DI4 (AXM-IO1-2)
7	Line Voltage BC	28	Phase C Power Factor	49	Phase B Current Demand	70	DI5 (AXM-IO1-2)
8	Average Line Voltage	29	Total Power Factor	50	Phase C Current Demand	71	DI6 (AXM-IO1-2)
9	Phase A Current	30	Voltage Unbalance Factor	51	Reverse Phase Sequence	72	DI1 (AXM-IO2-2)

Alarming Parameter Code	Alarming Parameter	Alarming Parameter Code	Alarming Parameter	Alarming Parameter Code	Alarming Parameter	Alarming Parameter Code	Alarming Parameter
10	Phase B Current	31	Current Unbalance Factor	52	DI1 (AXM-IO1-1)	73	DI2 (AXM-IO2-2)
11	Phase C Current	32	Load Characteristic	53	DI2 (AXM-IO1-1)	74	DI3 (AXM-IO2-2)
12	Average Current	33	Phase A (Vab) THD	54	DI3 (AXM-IO1-1)	75	DI4 (AXM-IO2-2)
13	Neutral Current	34	Phase B (Vac) THD	55	DI4 (AXM-IO1-1)	76	DI1 (AXM-IO3-2)
14	Phase A Power	35	Phase C (Vbc) THD	56	DI5 (AXM-IO1-1)	77	DI2 (AXM-IO3-2)
15	Phase B Power	36	Average Voltage THD	57	DI6 (AXM-IO1-1)	78	DI3 (AXM-IO3-2)
16	Phase C Power	37	Phase A Current THD	58	DI1 (AXM-IO2-1)	79	DI4 (AXM-IO3-2)
17	Total System Power	38	Phase B Current THD	59	DI2 (AXM-IO2-1)		
18	Phase A Reactive Power	39	Phase C Current THD	60	DI3 (AXM-IO2-1)		
19	Phase B Reactive Power	40	Average Current THD	61	DI4 (AXM-IO2-1)		
20	Phase C Reactive Power	41	Analog Input Channel 1 (AXM-IO3-1)	62	DI1 (AXM-IO3-1)		

4.7.1 Alarm Log

The Acuview II series meter has built-in alarm logging capabilities where 16 entries in total can be recorded.

The record sequence of these entries do not depend on the sequence of the 16 alarm channels. The meter begins logging alarm status starting from the 1st record location to the last one. Alarm logs are being recorded in a "cycle" fashion which means the latest event will overwrite the oldest record.

When over/under limit parameters return to normal, its value and timestamp will be recorded as well. Therefore, users can determine the over/ under limit duration by checking the time difference.

Readings > Alarm Log

No.	Time Stamp	ms	Alarm Channel	Value	Status	Limit ID
1	2019-08-20 11:55:58	321	Volts LN Average	120.7 V	Out	2
2	2019-08-20 11:58:20	782	Frequency	49.88 Hz	Out	1
3	2019-08-20 11:58:20	782	Volts AN	131.4 V	Out	4
4	2019-08-20 11:58:20	782	Volts BN	128.9 V	Out	5
5	2019-08-20 11:59:22	785	I A	19.00 A	Out	7
6	2019-08-20 11:59:22	785	I C	19.00 A	Out	9
7	2019-08-20 11:59:22	903	I Average	19.00 A	Out	3
8	0001-01-01 00:00:00	0	Frequency	0.00 Hz	In	0
9	0001-01-01 00:00:00	0	Frequency	0.00 Hz	In	0
10	0001-01-01 00:00:00	0	Frequency	0.00 Hz	In	0
11	0001-01-01 00:00:00	0	Frequency	0.00 Hz	In	0
12	0001-01-01 00:00:00	0	Frequency	0.00 Hz	In	0
13	0001-01-01 00:00:00	0	Frequency	0.00 Hz	In	0
14	0001-01-01 00:00:00	0	Frequency	0.00 Hz	In	0
15	0001-01-01 00:00:00	0	Frequency	0.00 Hz	In	0

New Alarm Record? **Yes**

Newest Alarm Record No. **7**

Figure 4-18 - Alarming Records

No.: There are 16 alarm entries in the alarm log and this number indicates the alarm number. For example, the newest alarm record number in Figure 4-18 is record entry 7.

Timestamp: The Acuvim II meter can log the timestamp for when the alarm occurred. The timestamp format is YYYY-MM-DD hh:mm:ss. The column to the right provides the millisecond reading for the timestamp.

Alarm Channel: The alarm channel column specifies which parameter in the Acuvim II meter was triggered.

Value: Displays the value that triggers the alarm condition as well as the value that brings the alarm back into normal condition.

Alarming Status: Indicates whether the alarm is triggered or not. For example, when the status is **OUT**, the alarm is triggered. When the alarm status is **IN**, the alarm is back to its normal condition.

Limit ID: Refers to the alarm (1-16) that was configured in the alarm settings.

Users can check whether there is a new alarm record as well as the log number associated with newest alarm record. The alarm log can also be reset from the software, the meter display (refer to Chapter 3 for screen sequence), or through Modbus communication (refer to Chapter 6).

The alarm logs can be saved via the Acuvim software as either plain text, .csv, or as an Excel file.

4.8 Meter Settings

The meter settings can be configured from the meter display (refer to chapter 3 for screen sequencing), through the Modbus registers (refer to chapter 6) and from the Acuvim software. The meter settings need to be configured correctly in order for the Acuvim II meter to read data. After configuring any of the meter settings users will need to click on **Update Device** at the bottom of the settings page in order for the setting to take effect.

Settings > Power Meter > General

Communication Channel 1

Protocol: Modbus Address: 1 Baud Rate: 19200 bps Parity: None 1

Communication Channel 2

Protocol: Default Address: 1 Baud Rate: 38400 bps Parity: None 1

Wiring

Voltage: 3LN Current: 3CT

PT and CT Ratios

PT1: 400.0 V PT2: 400.0 V CT1: 1000 A CT2: 100 mV

Real-Time Reading

Secondary Primary

I L1 Direction: Positive Negative

I L2 Direction: Positive Negative

I L3 Direction: Positive Negative

Security: Change Password

Demand: Sliding Window Demand Sub-Interval: 1 min

Demand: Averaging Interval Window: 1 min

Other: Turn On the Backlight: 1 min

DO Energy Pulse Const

Watt: 5000 Pulse/kWh VAR: 5000 Pulse/kvarh

Energy Type: Fundamental Fund. + Harm.

Energy Reading: Primary Secondary

VAR/PF Convention: IEC IEEE

VAR Calculation Method: Method 1 (True) Method 2 (Generalized)

SOE Enabled: None AXM-IO11 AXM-IO21 AXM-IO31 AXM-IO12 AXM-IO22 AXM-IO32

Non-Standard Seal Options of Seals

Device Run-Time Communication Channel 1

DI Counters Communication Channel 2

Device Clock + TOU Related

Load: Percentage of: Current Rated Watt Total: 1200 W

Update Device

Figure 4-19 - Basic Meter Settings

4.8.1 Communication

- **Communication Channel 1** - Refers to the meters RS485 communication port; the settings here are relative to Modbus RTU or DNP over serial communication.
 - **Protocol** - Can be set as Modbus or DNP, Modbus is default
 - **Address** - Is the slave ID, the default is 1 and the range is 1-247.
 - **Baud Rate** - The communication speed in bits per second. The default is 19200 and the range is 1200-38400.
 - **Parity** - Is the communication parity; the default is None 1 which means no parity and 1 stop bit.
- **Communication Channel 2** - Refers to the secondary communication of the meter and is typically communications module (i.e. AXM-WEB2, AXM-MESH, AXM-BMS, etc.).
 - **Protocol** - Is the protocol used for the communications module; by default, it is set for OTHER, which is compatible with the Ethernet communications module. When using AXM-MESH, the protocol should be set for MESH. When using AXM-BMS, the protocol should be BACnet. When using AXM-WEB2, the protocol should be WEB2.
 - **Address** - The address to be used for accessing the meter via the communication protocol. For example, if using an Ethernet module and accessing the meter via Modbus TCP, this address would be used as the slave ID.
 - **Baud Rate** - The baud rate should be the communication speed required for communication between meter and communications module. By default, this is set for 38400 which is compatible with AXM-WEB2 and AXM-WEB-PUSH modules. However, if using the AXM-MESH module, the baud rate must be configured as 9600.
 - **Parity** - The parity setting is None 1 by default which is required for communication with the external communication modules.

4.8.2 Wiring, CT/PT Ratios

- **Wiring Mode**
 - **Voltage** - The Voltage wiring refers to the type of system that is being monitored by the Acuvim II meter. By default, the wiring is set 3LN (3 line and neutral) connection. For more information regarding wiring, refer to Chapter 2.
 - **Current** - The Current wiring setting refers to the number of CTs being used. By default, the meter is set for 3CT; for more information regarding CT wiring see Chapter 2.
- **CT/PT Ratio**

- **PT1** - If using Potential Transformers with the meter at the voltage input, this setting refers to the Primary side rating of the transformer. The range is from 50.0-1000000.0. If PTs are not being used with the meter, this setting can be left as the default which is 400.0.
- **PT2** - If using Potential Transformers with the meter at the voltage input, this setting refers to the Secondary side rating of the transformer. The range is from 50.0-400.0. If PTs are not being used with the meter, this setting can be left as the default which is 400.0.
- **CT1** - The CT1 setting refers to the Primary side rating of the current transformers being used with the meter. For example, if 200:5A CTs were being used, the CT1 setting would be configured as 200. Range is from 5-50000. The default CT1 value for 5A current input meters is 5, the default for 333mV/mA current inputs is 1, and the default for RCT current input meters is 1000.
- **CT2** - The CT2 setting refers to the secondary output of the current transformers. By default, the CT2 setting is already configured based on the current input type for the AcuVim II meter. For example, if you have a 5A current input meter, the CT2 value will already be configured for 5A. If you have a 333mV current input meter, the CT2 value is 333, and if you have an RCT current input meter, the CT2 value is 120/60 (120mV per 60Hz).

NOTE: For 5A current input meters, the CT2 value can be changed from 5A to 1A to support 1A secondary output CTs. The mA type current input meters can change the CT2 value from 80mA/100mA/200mA.

- **Real Time Reading** - The real time reading setting affects the Modbus registers read out of the AcuVim II meter. By default, the meter is set for Secondary mode which requires that a multiplier be applied to the register readout. In Primary mode, no multiplier is required.

NOTE: The real time reading setting does not affect the reading on the meter's display. It only affects the Modbus register reading of the meter when polling the Modbus registers.

- **Current Direction Setting** - The AcuVim II supports a setting that allows users to changed the current direction in the meter. This is beneficial is the CTs have been installed in the reverse direction or if the leads have been terminated to the meter in reverse polarity. By default The current direction is configured to **positive** for I1, I2 and I3. Changing the current direction to negative is basically changing the phase angle of the current by 180 degrees allowing for correct adjustment if there is an installation error.

4.8.3 Demand Settings

- **Demand Calculation Method** - There are four types of demand that the Acuvim II meter supports: Fixed, Sliding Window, Thermal, and Rolling Window. See section 4.3 for a description for each calculation method.
- **Average Interval Window** - Is the averaging time used in the demand calculation method. The default is 15 minutes, and the range is from 1-30 minutes.
- **Sub-Interval** - The sub-interval time is used in the rolling block method where the sub-interval must be a factor of the averaging interval window. The default is 1 minute and the range is from 1-30 minutes.

4.8.4 Energy Reading & Power Factor Settings

- **Energy Type** - Users can configure the energy type as either fundamental or fundamental + harmonics.
- **Energy Reading** - The energy reading affects the meter calculation. If set for Primary, the meter will accumulate according to the primary usage. However, if configured as Secondary, the meter will use the secondary values for the energy accumulation where the resolution of 1 Wh can be seen.
- **VAR/PF Convention** - Users can select the convention as either IEC or IEEE.
- **VAR Calculation Method** - There are two ways to calculate reactive energy (power):
 1. **True Method** - This method uses the Budeanu Concept to calculate the **True** reactive power. This method generally uses the harmonic components to do the calculation instead of using the power vector triangle method. The most common definition of reactive power is Budeanu's definition, given by following expression for single phase circuit:

$$Q_b = \sum_{k=1}^{+\infty} I_{k,RMS} \cdot V_{k,RMS} \cdot \sin(\theta_k - \psi_k)$$

Budeanu proposed that apparent power consists of two orthogonal components, active power and nonactive power, which is divided into reactive power and distortion power:

$$D_b = \sqrt{S^2 - P^2 - Q_b^2}$$

2. **Generalized Method** - This method uses Fryze's concept to calculate the **Generalized** reactive power. This method separates instantaneous current into two components, active and

reactive currents. Active current is calculated as:

$$i_a(t) = \frac{P}{V_{\text{RMS}}^2} v(t)$$

And reactive current as:

$$i_r(t) = i(t) - i_a(t).$$

Active and reactive powers are as follows, where I_a and I_r represents RMS values of instantaneous active and reactive currents:

$$P = V_{\text{RMS}} \cdot I_a$$
$$Q_f = V_{\text{RMS}} \cdot I_r$$

4.8.5 Load Percentage

The rated load can be represented in terms of either current or power.

- If current is selected, the rated current that is used would be the CT1 setting value in the PT/CT ratio settings. For example, if CT1 is set for 1000A and the average current the meter is monitoring is 500A, the load percentage would be 50% (500/1000).
- If power is selected, the rated primary power would be used in the load percentage calculation. The max primary power can be calculated as follows:

Max Primary Power without using PTs = 3 * (480) * (CT1)

Max Primary Power using PTs = 3 * (PT1) * (CT1)

The max primary power would be the power that is entered in the **Rated Watt Total** setting.

The load percentage is displayed on the front of the Acuvim II meter display. The load percentage is calculated based on the following equation:

$$\text{Load Percentage} = \left(\frac{\text{Active System Power}}{5A \text{ or } 1A \times \text{User Setting}} \right) \times 100\%$$

Where the meter will have either a 5A or 1A current input. If users have Acuvim II meters with

Rogowski Coil (RCT), 333mV, or mA type Current Inputs, then 1A is used in this equation.

For example, if the max primary power of your system is 576000W (or 576kW), your system is currently using 211kW and the meters current input type is 5A, then the load percentage would be calculated as follows:

$$\text{Load Percentage} = \left(\frac{211kW}{5 \times 576kW} \right) \times 100\% = 7\%$$

The load percentage can only be viewed on the front LCD display of the Acuvim II meter; figure 4-20 shows where it is located on the display.

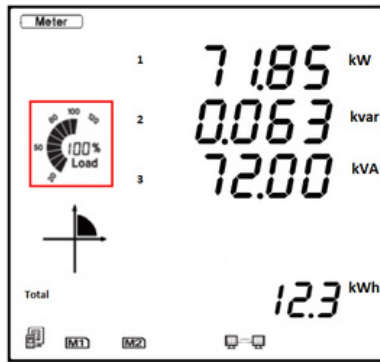

Figure 4-20 - Load Percentage

4.9 Time & Date Configuration

The meter can have its time and date configured only from the Acuviv software or by writing to the Modbus registers (refer to chapter 6), this is not configurable from the meter display. From the Acuviv software under the **System Status** section in the **Readings** tab users can configure the time and date for the meter.

The meter's time can be saved when the meter is powered off. However, if the meter is powered off for seven days or longer, the meter will reset back to its default time.

Users have the option to configure the time manually or synchronize with the PC's time to configure the time & date. Simply click on the **Set Device Clock** button for the setting to take affect.

NOTE: If users have a communications module, they will need to also configure the time from the module's web interface for the time to take effect.

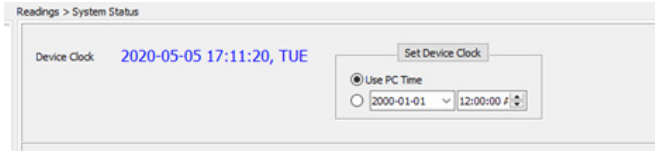

Figure 4-21 - Device Clock Configuration

4.10 Data Logging

The Acuvim IIR/IIW models support data logging onto the meter internal memory, where these models include 8MB of memory. The base model Acuvim II does not have the internal memory and does not support data logging capabilities. The meter is able to log data and store it on to the meters internal memory where users can read and pull the data from the memory. The data is logged and has time-stamps to allow users to monitor the exact time each record was logged at. Data logging is useful for users who wish to analyze the meters data for further research and billing purposes.

NOTE: *If users have the base Acuvim II model, they can log data onto the computer's memory, however the Acuvview software must be running at all times in order for this to occur.*

4.10.1. Data Log Setting

The Acuvim IIR/IIW meters have three data logs available where each log can be independently programmed with individual settings. This means that each data log can be used to monitor different types of parameters, where the user can program up to 117 parameters per log.

Data Logging Parameters - Users can select the data logging parameters on the software from the parameter box located on the left of the interface. Users can select different types of parameters by selecting the parameter type in the drop down menu. The following types of parameter types are available for data logging:

- **Real-Time Metering** - Includes real time parameters such as voltage, current, power, etc.
- **Demand** - Includes both power and current demand parameters.
- **Energy** - Includes all energy types such as import, export, net, total, reactive, etc.
- **THD** - These parameters include all THD parameters such as THF, Crest Factor, THFF, etc.
- **Voltage & Current Harmonics** - Includes all individual harmonic parameters (2nd-63rd order harmonics for each voltage and current phase).
- **Sequence Components** - Includes positive, negative, and zero sequence components.
- **Phase Angle** - Voltage and Current phase angle parameters

- **DI Counter** - If using an external I/O module, the user can log the DI counter value
- **Analog Output/Input Raw & Scaled values** - Users have the option to log the AO/AI values—both the raw values as well as the scaled values. More information on scaling for AO/AI can be found in Chapter 5.

Users can click and select the which parameters they want to log and click on the **Add** button to add the parameters to the log. Parameters can be deleted by selecting the parameter and clicking on the **Remove** button. Users can simply clear the entire data log by clicking on the **Clear All** button.

Memory Usage - As users add parameters to the data log there is **Space Allocation** section of the software that allows users to monitor the memory. Each data log can have 228 bytes, and each parameter uses roughly 4 bytes which then allows for a maximum of approximately 57 parameters per data log. The Max records will be dependent on the sector percentage that is configured for the data log. More records will be available the higher the sector percentage is.

Registers & Sectors - In this section, users can drag the **Sector** bar to an appropriate value. The sector range is from 0-100. Having the bar at the maximum of 100 means the data log will use all of the meter's memory. The total sector number between Data Log 1, Data Log 2 and Data Log 3 must not be more than 100. For example:

- If you are using just Data Log 1, you can have the sector all the way to 100
- If you are using Data Log 1 and Data Log 2, you can have both sectors at 50
- If you are using Data Log 1, Data Log 2 and Data Log 3, you can have the sectors at 30, 30, and 40.

Logging Interval - The logging interval determines how often the data is recorded in the data log. The logging interval can be configured from 1-1440 minutes, if the interval is set as 0 the data log is disabled. If users wish to log at quicker intervals they will need to use an communications module (AXM-WEB2 or WEB-PUSH) with the Acuvim II meter to log as fast as 1 second.

Logging Mode - There are three different types of logging modes that can be configured. Please note that the time will need to be configured correctly on the meter in order for the data to log successfully.

- **Immediate** - This starts logging immediately and does not stop. When the memory is full, the meter starts to overwrite the data from the oldest data log entry (first-in, first-out method).
- **Start Time** - This mode has a specific start time for the meter to begin logging. Users will

need to specify the start time by selecting the hour and minute. Once the data starts to log, it does not stop and, like the immediate logging mode, the data will start to overwrite the oldest data log entry once the memory is full.

- **Time Interval** - In this mode, there is a specific time interval where the meter is logging data. Users will need to specify both the start and end time for the data log. This will continue to log until the end time is reached or until the memory is full.

Once all configuration is complete user must click on **Update Device** at the bottom of the page, when updating the device data log 1,2, and 3 will be erased. If at anytime the user changes the data log configuration, when updating the device the existing data logs will be erased. It is important that users download and save all data logs before changing the configuration.

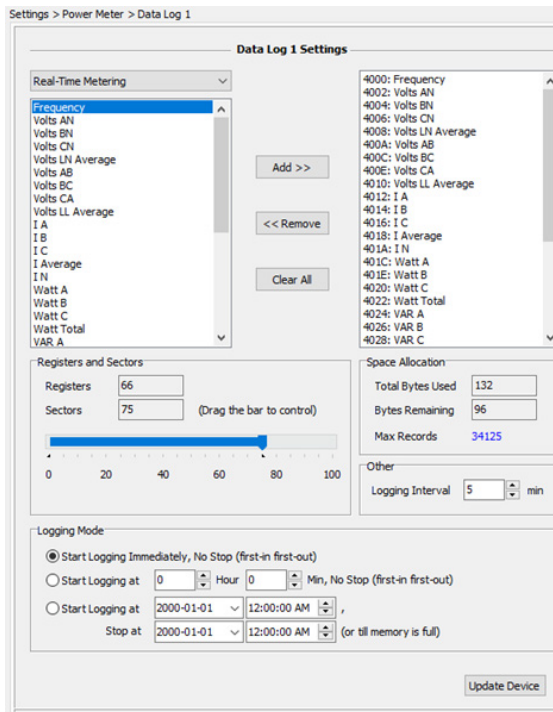

Figure 4-22 - The Data Log 1 Setting

NOTE: If the memory of the historical data log is full, the meter will erase the first sector in which the memory size is 65536 bytes (64kb). The following sector (the second sector) will become the first sector and the data from the erased sector will not be recoverable. Therefore, the user should save the whole log before the memory is full to maintain all data.

4.10.2 Retrieving the Data Log

The data logs can be retrieved directly from the Acuvim software or by Modbus (refer to Chapter 6). In the Acuvim software, under the readings tab, select **Data Log**. The top of the screen will show an overview of the three data logs which include the Max number of records for the data log, the number of used records, the record size, the window status, and the first/last recorded timestamp.

In the drop-down menu, users can select which data log they wish to retrieve the data from. By default, Data Log 1 will appear—use the drop-down menu to switch between Data Log 1, 2, and 3.

In the second drop-down menu, users can select the number of records, or a specific range of records, they wish to view. The following options are available:

- Read newest 50 records
- Read 1000 records
- Read 64000 records
- Read 1000 records (Select Time)
- Read 64000 records (Select Time)

In the **Start Record Num** users have the option to select which record number to begin reading the data log, this is not valid when reading the newest 50 records but is valid for all other reading options.

Once the data log settings are configured click on **Read**, the data will begin to populate and will take several minutes depending on the amount of records selected to read. The data will appear in a tabular format where users can scroll through the data. Figure 4-21 shows the data retrieval.

There are options to save the data where the data log file can be saved as a text, csv, or excel file. This is done by using the **Save to File** button.

Readings > Data Log

Data Log 1	Data Log 2	Data Log 3
Max Records: 109200	Max Records: 182000	Max Records: 0
Used Records: 12696	Used Records: 12696	Used Records: 0
Record Size: 30	Record Size: 18	Record Size: 12
Window Status: Normal	Window Status: Normal	Window Status: Normal
First Record Time Stamp: 2019-03-27 17:55:00	First Record Time Stamp: 2019-03-27 17:55:00	First Record Time Stamp: 0001-01-01 00:00:00
Last Record Time Stamp: 2019-08-20 12:30:00	Last Record Time Stamp: 2019-08-20 12:30:00	Last Record Time Stamp: 0001-01-01 00:00:00

Data Log 1 | Read newest 90 records | Start Record Num: 1

Save to File | Data Log 1 (12647-12696) | Read | Stop

No.	Time Stamp	Ph Angle V (B)	Ph Angle V (C)	Ph Angle V (BC)	Ph Angle I A (V)	Ph Angle I B (V)	Ph Angle I C (V)	Ph Angle I A (V)	Ph Ang
12647	2019-08-20 11:41:00	107.7°	237.1°	0.0°	354.0°	113.9°	231.4°	0.0°	0.0°
12648	2019-08-20 11:42:00	103.6°	234.0°	0.0°	351.1°	111.2°	229.4°	0.0°	0.0°
12649	2019-08-20 11:43:00	103.1°	233.0°	0.0°	351.1°	111.2°	229.4°	0.0°	0.0°
12650	2019-08-20 11:44:00	108.3°	236.0°	0.0°	354.0°	113.9°	229.4°	0.0°	0.0°
12651	2019-08-20 11:45:00	103.7°	234.7°	0.0°	351.1°	111.2°	229.4°	0.0°	0.0°
12652	2019-08-20 11:46:00	103.5°	232.7°	0.0°	351.1°	111.2°	229.4°	0.0°	0.0°
12653	2019-08-20 11:47:00	103.8°	231.8°	0.0°	351.1°	111.2°	229.4°	0.0°	0.0°
12654	2019-08-20 11:48:00	108.2°	236.7°	0.0°	354.0°	113.9°	229.4°	0.0°	0.0°
12655	2019-08-20 11:49:00	107.9°	233.7°	0.0°	354.0°	113.9°	229.4°	0.0°	0.0°
12656	2019-08-20 11:50:00	103.7°	233.9°	0.0°	351.1°	111.2°	229.4°	0.0°	0.0°
12657	2019-08-20 11:51:00	104.1°	231.8°	0.0°	351.1°	111.2°	229.4°	0.0°	0.0°
12658	2019-08-20 11:52:00	103.6°	234.5°	0.0°	351.1°	111.2°	229.4°	0.0°	0.0°
12659	2019-08-20 11:53:00	105.7°	231.6°	0.0°	351.1°	111.2°	229.4°	0.0°	0.0°
12660	2019-08-20 11:54:00	106.7°	231.9°	0.0°	351.1°	111.2°	229.4°	0.0°	0.0°
12661	2019-08-20 11:55:00	106.7°	232.3°	0.0°	351.1°	113.9°	229.4°	0.0°	0.0°
12662	2019-08-20 11:56:00	107.9°	236.5°	0.0°	354.0°	113.9°	229.4°	0.0°	0.0°
12663	2019-08-20 11:57:00	108.1°	234.8°	0.0°	354.0°	113.9°	229.4°	0.0°	0.0°
12664	2019-08-20 11:58:00	106.4°	237.4°	0.0°	354.0°	113.9°	229.4°	0.0°	0.0°
12665	2019-08-20 11:59:00	107.2°	237.1°	0.0°	354.0°	113.9°	229.4°	0.0°	0.0°
12666	2019-08-20 12:00:00	108.5°	236.1°	0.0°	354.0°	113.9°	231.4°	0.0°	0.0°

Figure 4-23 - Data Log Retrieval Page

4.11 Time-of-Use (TOU)

Most utilities bill customers according to their Time-of-Use rates where customers are billed at certain rates depending on when the energy usage occurs. The Acuvim II meter supports a Time-of-Use functions that allows users to assign up to 4 different tariffs to different time periods within the day according to their billing requirements. The meter will calculate and accumulate energy to each of the different tariffs configured based on the meters time/date and TOU settings.

The Time-of-Use (TOU) must be configured from the Acuvim software by selecting **TOU** under the **Settings** tab.

4.11.1 General TOU Setting

- **Season Setting** - There can be a maximum of 12 seasons configured in the Acuvim II for the TOU settings. Each season will operate on the TOU Schedule it is configured to.
- **Schedule Setting** - There can be a maximum of 14 schedules. This parameter determines the number of TOU schedules available for the TOU calendar setting. Each schedule can be divided up into time segments and assigned a tariff.
- **Segment Setting** - A segment is included in a schedule and each schedule can have up to a maximum of 14 time segments. Each segment is assigned a tariff.

- **Tariff Setting** - The Acuvim II supports up to 4 tariffs in the TOU function. The range is 0-3 for this setting where 0 means 1 tariff and 3 means all 4 tariffs are used.
 - 0 - Sharp
 - 1 - Sharp, Peak
 - 2 - Sharp, Peak, Valley
 - 3 - Sharp, Peak, Valley, Normal
- **Weekend Setting** - Allows users to assign which day(s) of the week to consider as weekends. The weekend setting can be set by making use of the following relationship where the 7 days of the week can be represented by 7 bits. The least significant bit (bit0) represents Sunday and bit1-bit6 represent Monday to Saturday.
 - A bit that is **0** represents the day is not a weekend
 - A bit that is **1** represents the day is a weekend
 - The decimal representation of the binary value is what is entered in the setting and the range is from 0-127. For example, to set Saturday and Sunday as weekend, the binary number would be 1000001, which is 65 in decimal.
- **Weekend Schedule** - If there are weekend settings, the user can configure which schedule to use for the weekend. Select the schedule number that is in reference to the weekend rates.
- **Holiday Setting** - A maximum of 30 holidays can be programmed to the TOU calendar. If the holiday setting parameter is set as 3, the first 3 slots of the holiday schedule must be set, otherwise, it will be considered as an invalid input (TOU function will be disabled).
- **Fault Status Word** - This will display a hex word if there is an error present in the TOU settings. This word should read 0 if all settings are correct. Table 4-4 explains the different error codes that can be displayed on the software. The Hex values are displayed in the Acuvview software.

Table 4-4 Fault Status Word Translation Table

Error Code (Hex)	Error Code (Decimal)	Meaning of Error Code
0	0	Correct TOU settings
1	1	Tariff number setting error
4	4	Schedule setting Error
8	8	Season Setting Error
A	10	Segment Setting Error
C	12	Schedule Setting Error
10	16	Parameter of Season Setting Error
20	32	Holiday Number Setting Error
40	64	Parameter of Holiday Setting Error

Error Code (Hex)	Error Code (Decimal)	Meaning of Error Code
100	256	Tariff of Schedule Setting Error
200	512	Time of Schedule Setting Error
400	1024	Time sequence on schedule setting Error
800	2048	Weekend Schedule Number Setting Error
1000	4096	Weekend Setting Error

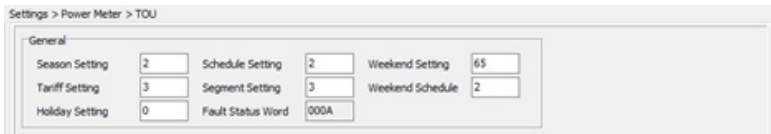

Figure 4-24 - TOU General Settings

4.11.2 Monthly Billing Mode

Users can select the monthly billing that matches their billing requirement, where the billing mode can be at the end of every month or a specific time and date. The format for the time method is DD HH:MM:SS.

In this section, users can enable the TOU function in the Acuvim II meter by checking the box from the software. Users also have the option to restore the TOU setting back to its default settings from this section.

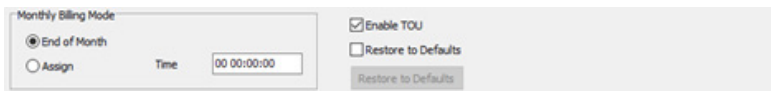

Figure 4-25 - TOU Monthly Billing Mode

4.11.3 TOU Seasons

Enter the start date into the TOU season table slot following format **MM-DD ID**.

- MM stands for month (range is from 1 to 12)
- DD stands for date/day (range is from 1 to 31)
- ID represents the TOU schedule to run (range is from 1-14)

The dates should be organized so that they are in sequence according to the calendar year (the earlier date comes first and the later date comes last). For example, if 2 seasons are selected,

the date parameters are March 31 and November 4, and TOU schedule 01, 02 will be used respectively, the first TOU season table slot shall enter 03-31 01, and the second slot shall enter 11-04 02. With this configuration the first season would be from March 31st to November 4th, and the second season would be from November 4th to March 31st.

NOTE: *If the slot is filled incorrectly, the TOU function will be disabled*

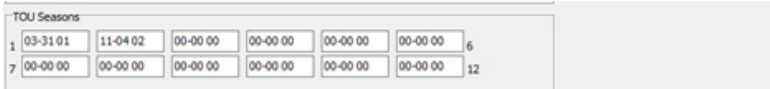

TOU Seasons						
1	03-31 01	11-04 02	00-00 00	00-00 00	00-00 00	00-00 00 6
7	00-00 00	00-00 00	00-00 00	00-00 00	00-00 00	00-00 00 12

Figure 4-26 - TOU Season Configuration

4.11.4 TOU Schedule

The TOU Schedule Format can be seen in Figure 4-27, where each TOU schedule represents a 24-hour cycle. Similar to the TOU season format, enter the start time into the TOU schedule table slot following this format: HH:MM ID:

- HH stands for hour (range is in 24-hour format, 0 to 24 hours)
- MM stands for minutes (range is from 00 to 60 minutes)
- ID stands for tariffs (available from 00 to 03).

The time should be organized according to the hour sequence. For example, if 3 segments are configured, timing parameters are 01:00, 15:30, 22:45, the order of the 3 segments should be one of the following: 01:00, 15:30, 22:45 or 15:30, 22:45, 01:00 or 22:45, 01:00, 15:30. Entering time information in a wrong sequence (for example, entering 15:30, 01:00, 22:45) is considered as an invalid operation and the TOU function will be disabled.

In figure 4-27 below, TOU Schedule #1 can be described as follows:

- From 12AM to 11AM all energy consumed will be accumulate under the Sharp Tariff (Tariff ID 0)
- From 11AM to 5PM all energy consumed will be accumulated under the Peak Tariff (Tariff ID 1)
- From 5PM to 6PM all energy consumed will be accumulated under the Valley Tariff (Tariff ID 2)
- From 6PM to 8PM all energy consumed will be accumulated under the Normal Tariff (Tariff ID 3)
- From 8PM to 11AM all energy consumed will be accumulated under the Sharp Tariff (Tariff ID 0)

TOU Schedule #1							
1	00:00 00	11:00 01	17:00 02	18:00 03	20:00 00	00:00 00	00:00 00
8	00:00 00	00:00 00	00:00 00	00:00 00	00:00 00	00:00 00	00:00 00

TOU Schedule #2							
1	00:00 00	10:00 01	00:00 00	00:00 00	00:00 00	00:00 00	00:00 00
8	00:00 00	00:00 00	00:00 00	00:00 00	00:00 00	00:00 00	00:00 00

TOU Schedule #3							
1	00:00 00	00:00 00	00:00 00	00:00 00	00:00 00	00:00 00	00:00 00
8	00:00 00	00:00 00	00:00 00	00:00 00	00:00 00	00:00 00	00:00 00

Figure 4-27 - TOU Schedule Configuration

4.11.5 Weekend Settings

Weekends (Alternative): In the case where a TOU schedule supports multiple schedules for a weekday or weekend within a season, the **Weekends (Alternative)** can be enabled to allow that day to run a specific schedule.

NOTE: If this feature is not enabled, the days configured as a weekend in the "Weekend Setting" will follow the "Weekend Schedule".

Each season can be configured to run an alternative schedule:

- Assign each season with the day(s) that will run the alternative schedule.
- Enter the decimal representation of the binary value for the days that will run the alternative schedule in the first column of the boxes in the setting. These boxes are numbered to represent each of the 12 seasons that can be configured for TOU. The decimal representation can be determined as follows (same as in the "Weekend Setting")

Recall that the weekend setting can be set by making use of the following relationship:

The 7 days of the week can be represented by 7 bits. The least significant bit (bit0) represents Sunday and bit1-bit6 represent Monday to Saturday.

- A bit that is 0 means the day is not considered as a weekend.
- A bit that is 1 means the day is considered as a weekend.

Next, for the days that are configured to run an alternative schedule, these days of the week will need to be assigned a schedule to run. In the second column, enter the schedule number (01-14) for each day that will run the alternative schedule. Sunday to Saturday are represented from left to right.

NOTE: The days to fill in with the schedule number must correspond to the decimal representation set in the box to the left of this field.

<input checked="" type="checkbox"/> Weekends (Alternative)					
1	65	02,00,00,00,00,00,02	0	00,00,00,00,00,00,00	2
3	0	00,00,00,00,00,00,00	0	00,00,00,00,00,00,00	4
5	0	00,00,00,00,00,00,00	0	00,00,00,00,00,00,00	6
7	0	00,00,00,00,00,00,00	0	00,00,00,00,00,00,00	8
9	0	00,00,00,00,00,00,00	0	00,00,00,00,00,00,00	10
11	0	00,00,00,00,00,00,00	0	00,00,00,00,00,00,00	12

Figure 4-28 - Weekends Alternative Setting

4.11.6 Holiday Settings

The Acuvim II supports holiday configuration within its TOU function, where a maximum of 30 holidays can be programmed to the TOU calendar. Users can program the amount of holidays within the TOU calendar by entering a number from 0-30 on the holiday setting in the General section of the TOU settings. For example if the holiday setting parameter is set as 3, the first 3 slots of the holiday schedule must be set, otherwise, it will be considered as an invalid input (TOU function will be disabled).

To configure the Holiday timing users must set the holiday schedule, which uses the same format as the TOU seasons MM-DD ID. Users can select which TOU schedule to be used for the holiday. The dates of the holiday schedule do not need to be organized in sequential order (i.e. the first slot can be January 1, the second slot can be December 26 and the third slot can be December 25).

Holidays							
1	12-25 04	05-24 04	11-11 01	00-00 00	00-00 00	00-00 00	6
7	00-00 00	00-00 00	00-00 00	00-00 00	00-00 00	00-00 00	12
13	00-00 00	00-00 00	00-00 00	00-00 00	00-00 00	00-00 00	18
19	00-00 00	00-00 00	00-00 00	00-00 00	00-00 00	00-00 00	24
25	00-00 00	00-00 00	00-00 00	00-00 00	00-00 00	00-00 00	30

Figure 4-29 - TOU Holiday Schedule Configuration

Ten Year Holiday Setting

Users can preset holidays for the upcoming 10 years via the meter software. Since holiday dates change as the years go by, this feature allows users to preset the dates.

The holiday format is MM-DD ID, where the ID number is the schedule number to use for that holiday. Input all the holidays in the **Make Holiday Settings (10 year)** option located on the bottom of the page. Enter in the holiday dates, holiday code, and Schedule setting number. The holiday

codes are defined as follows:

- 0- Holiday only occurs once
- 1- Holiday occurs on the same date each year
- 2- Holiday occurs on the first Sunday on or after the date entered
- 3- Holiday occurs on the first Monday on or after the date entered
- 4- Holiday occurs on the first Thursday on or after the date entered
- 5- Holiday moved from Sunday to Monday
- 6- Holiday moved from Saturday to Friday or Sunday to Monday

Once all the holidays are entered in the TOU Holiday Code Settings, users can click on **Generate** to automatically populate and load all the holidays in the 10-year holiday settings. If the current year of the meter does not fall into the 10-year holiday setting, it remains as the current TOU settings.

NOTE: The holiday schedule has the highest priority among all the schedules. The weekend schedule's priority is followed by the Holiday schedule. When the holiday schedule is not enabled, the weekend schedule has the highest priority, overriding the normal (weekday) schedule.

Settings > Power Meter > Ten Years Holiday

Enable Holidays Years Settings

Start Year Ending Year

1st Year Holidays

1	01-01 1	02-01 2	03-01 3	04-01 4	05-01 5	00-00 00	6
7	00-00 00	00-00 00	00-00 00	00-00 00	00-00 00	00-00 00	12
13	00-00 00	00-00 00	00-00 00	00-00 00	00-00 00	00-00 00	18
19	00-00 00	00-00 00	00-00 00	00-00 00	00-00 00	00-00 00	24
25	00-00 00	00-00 00	00-00 00	00-00 00	00-00 00	00-00 00	30

Settings Year Holiday Number

2nd Year Holidays

1	01-01 1	02-01 2	03-01 3	04-01 4	05-01 5	06-01 6	6
7	07-01 7	08-01 8	09-01 9	10-01 10	00-00 00	00-00 00	12
13	00-00 00	00-00 00	00-00 00	00-00 00	00-00 00	00-00 00	18
19	00-00 00	00-00 00	00-00 00	00-00 00	00-00 00	00-00 00	24
25	00-00 00	00-00 00	00-00 00	00-00 00	00-00 00	00-00 00	30

Figure 4-30 - TOU 10 Years Holiday Configuration

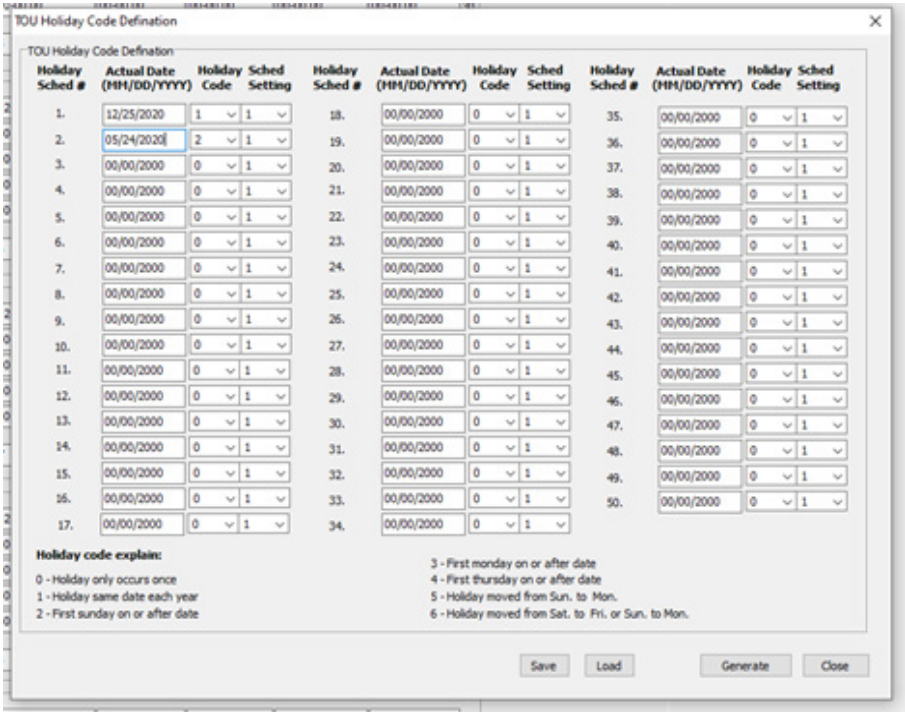

Figure 4-31 - TOU Holiday Code Definition

4.11.7 DST Settings

The Acuvim II series meter can adjust for the Daylight Savings Time and this function can be enabled from the Acuvim software. DST can be configured to follow one of two formats:

1. **Fixed date option** - If you choose a fixed date option, you set the format according to a fixed date for the DST switch. The format is Month/ Day/ Hour/ Minute/ adjusted time (in minutes).
2. **Non-Fixed date option** - If you choose the non-fixed option, DST will be implemented by which day of which week is selected. The format is Month/ Which Day/ Which Week/ Hour/ Minute/ adjusted time (in minutes).

Setting DST will cause the meter to automatically switch to and from daylight saving time. When the clock starts to follow daylight savings time, the meter will automatically adjust its clock to the new, correct time. When daylight savings time ends, the meter will automatically adjust again back to standard time.

Figure 4-32 - Daylight Savings Time Settings

4.11.8 Reading the TOU data

Users can read the TOU data under the **Current Month TOU** option in the Readings tab. From here, users will be able to view all consumption for each tariff as well as the consumption total during the TOU period. Acuvim II can also record maximum power and current demand under different tariffs, as well as the timestamp of the maximum value. From here, the maximum demand value can be cleared for different tariffs.

The Current Month TOU is divided into two sections: Accumulated and Incremental.

Current Month TOU (Accumulated): Refers to the TOU energy accumulated in the current month.

Current Month TOU (Incremental): Refers to the TOU energy accumulated in this month minus the TOU energy accumulated in the prior month.

Readings > Energy > Current Month TOU

Current Month TOU (Accumulated)					
	Sharp	Peak	Valley	Normal	Total
Ep_imp	7025.3 kWh	4560.3 kWh	1169.8 kWh	1120.2 kWh	13925.6 kWh
Ep_exp	0.0 kWh	0.0 kWh	0.0 kWh	0.0 kWh	0.0 kWh
Eq_imp	0.0 kWh	0.0 kWh	0.0 kWh	0.0 kWh	0.0 kWh
Eq_exp	2503.9 kWh	1618.7 kWh	409.1 kWh	412.1 kWh	4943.8 kWh
Es	11632.8 kWh	7571.8 kWh	1937.7 kWh	1939.2 kWh	23081.5 kWh

Current Month TOU (Incremental)					
	Sharp	Peak	Valley	Normal	Total
Ep_imp	7025.3 kWh	4560.3 kWh	1169.8 kWh	1120.2 kWh	13925.6 kWh
Ep_exp	0.0 kWh	0.0 kWh	0.0 kWh	0.0 kWh	0.0 kWh
Eq_imp	0.0 kWh	0.0 kWh	0.0 kWh	0.0 kWh	0.0 kWh
Eq_exp	2503.9 kWh	1618.7 kWh	409.1 kWh	412.1 kWh	4943.8 kWh
Es	11632.8 kWh	7571.8 kWh	1937.7 kWh	1939.2 kWh	23081.5 kWh

Figure 4-33 - Current Month TOU Readings

Maximum Demand					
	Sharp	Peak	Valley	Normal	Total
Watt (imp)	2.080 kW 2020-05-08 15:02:34	2.080 kW 2020-05-08 15:05:21	2.080 kW 2020-05-08 18:00:00	2.080 kW 2020-05-08 20:00:00	2.080 kW 2020-05-08 15:02:34
Watt (exp)	0.000 kW 2020-05-08 15:02:34	0.000 kW 2020-05-08 15:05:21	0.000 kW 2020-05-08 18:00:00	0.000 kW 2020-05-08 20:00:00	0.000 kW 2020-05-08 15:02:34
VAR (imp)	0.000 kvar 2020-05-08 15:02:34	0.000 kvar 2020-05-08 15:05:21	0.000 kvar 2020-05-08 18:00:00	0.000 kvar 2020-05-08 20:00:00	0.000 kvar 2020-05-08 15:02:34
VAR (exp)	-0.800 kvar 2020-05-22 07:54:33	-0.800 kvar 2020-05-21 14:37:15	-0.720 kvar 2020-05-08 18:00:00	-0.720 kvar 2020-05-08 20:00:00	-0.800 kvar 2020-05-21 14:37:15
VA	3.600 kVA 2020-05-19 08:17:23	3.600 kVA 2020-05-19 13:00:28	3.520 kVA 2020-05-08 18:00:00	3.520 kVA 2020-05-08 20:00:00	3.600 kVA 2020-05-19 08:17:23
I A	5.040 A 2020-05-19 09:28:24	5.120 A 2020-05-21 14:52:16	4.960 A 2020-05-21 18:00:00	4.960 A 2020-05-19 21:04:35	5.120 A 2020-05-21 14:52:16
I B	5.040 A 2020-05-19 09:26:24	5.120 A 2020-05-21 14:52:16	4.960 A 2020-05-19 19:32:34	4.960 A 2020-05-19 21:04:35	5.120 A 2020-05-21 14:52:16
I C	5.040 A 2020-05-19 09:27:24	5.120 A 2020-05-21 14:52:16	4.960 A 2020-05-19 19:32:34	4.960 A 2020-05-19 21:04:35	5.120 A 2020-05-21 14:52:16

Figure 4-34 - Peak Demand Readings

The TOU function displays the prior month TOU readings from the Acuvue software. This allows users to compare the current month and previous month's readings for billing and analytical purposes. These readings can be viewed in the software by clicking on the **Prior Month TOU** option under the **Readings tab**. Similar to the current month, the prior month also allows users to view the Max Demand readings.

Readings > Energy > Prior Month TOU

Prior Month TOU (Accumulated)					
	Sharp	Peak	Valley	Normal	Total
Ep_imp	0.0 kWh	0.0 kWh	0.0 kWh	0.0 kWh	0.0 kWh
Ep_exp	0.0 kWh	0.0 kWh	0.0 kWh	0.0 kWh	0.0 kWh
Eq_imp	0.0 kvarh	0.0 kvarh	0.0 kvarh	0.0 kvarh	0.0 kvarh
Eq_exp	0.0 kvarh	0.0 kvarh	0.0 kvarh	0.0 kvarh	0.0 kvarh
Es	0.0 kWh	0.0 kWh	0.0 kWh	0.0 kWh	0.0 kWh

Prior Month TOU (Incremental)					
	Sharp	Peak	Valley	Normal	Total
Ep_imp	0.0 kWh	0.0 kWh	0.0 kWh	0.0 kWh	0.0 kWh
Ep_exp	0.0 kWh	0.0 kWh	0.0 kWh	0.0 kWh	0.0 kWh
Eq_imp	0.0 kvarh	0.0 kvarh	0.0 kvarh	0.0 kvarh	0.0 kvarh
Eq_exp	0.0 kvarh	0.0 kvarh	0.0 kvarh	0.0 kvarh	0.0 kvarh
Es	0.0 kWh	0.0 kWh	0.0 kWh	0.0 kWh	0.0 kWh

Figure 4-35 - Prior Month TOU Readings

Prior Month Maximum Demand					
	Sharp	Peak	Valley	Normal	Total
Watt (mp)	0.000 kW 2000-00-00 00:00:00	0.000 kW 2000-00-00 00:00:00	0.000 kW 2000-00-00 00:00:00	0.000 kW 2000-00-00 00:00:00	0.000 kW 2000-00-00 00:00:00
Watt (exp)	0.000 kW 2000-00-00 00:00:00	0.000 kW 2000-00-00 00:00:00	0.000 kW 2000-00-00 00:00:00	0.000 kW 2000-00-00 00:00:00	0.000 kW 2000-00-00 00:00:00
VAR (mp)	0.000 kvar 2000-00-00 00:00:00	0.000 kvar 2000-00-00 00:00:00	0.000 kvar 2000-00-00 00:00:00	0.000 kvar 2000-00-00 00:00:00	0.000 kvar 2000-00-00 00:00:00
VAR (exp)	0.000 kvar 2000-00-00 00:00:00	0.000 kvar 2000-00-00 00:00:00	0.000 kvar 2000-00-00 00:00:00	0.000 kvar 2000-00-00 00:00:00	0.000 kvar 2000-00-00 00:00:00
VA	0.000 kVA 2000-00-00 00:00:00	0.000 kVA 2000-00-00 00:00:00	0.000 kVA 2000-00-00 00:00:00	0.000 kVA 2000-00-00 00:00:00	0.000 kVA 2000-00-00 00:00:00
I A	0.000 A 2000-00-00 00:00:00	0.000 A 2000-00-00 00:00:00	0.000 A 2000-00-00 00:00:00	0.000 A 2000-00-00 00:00:00	0.000 A 2000-00-00 00:00:00
I B	0.000 A 2000-00-00 00:00:00	0.000 A 2000-00-00 00:00:00	0.000 A 2000-00-00 00:00:00	0.000 A 2000-00-00 00:00:00	0.000 A 2000-00-00 00:00:255
I C	0.000 A 2000-00-00 00:00:00	0.000 A 2000-00-00 00:00:00	0.000 A 2000-00-00 00:00:00	0.000 A 2000-00-00 00:00:00	10.20 A 2000-255-00 255:00:255

Figure 4-36 - Prior Month TOU Peak Demand Readings

When setup appropriately and when TOU is enabled, energy will be accumulated on a month-to-month basis. The current energy usage will be stored under Current Month TOU (or Current Accumulation Month TOU) and is divided up into different tariffs. When the next month (or counting period) starts, all Current Month TOU values will be moved to the Prior Month TOU (or Prior Accumulation Month TOU).

The current month TOU will be reset depending on the billing method specified in the TOU settings, which can be either End of Month or Assigned Clock.

1. End of Month: This is the default method. All values from Current Month TOU (Accumulated) will be copied over to Prior Month TOU (Accumulated) at the very beginning of each month (the first day of each month at time 00:00:00). Current Accumulation Month TOU will continue to accumulate and all values from Current Month TOU will be copied over to Prior Month TOU at the very beginning of each month (the first day of each month at time 00:00:00) be cleared and reset to 0.

2. Assigned Clock: User can select when the values from Current Month TOU (Accumulated) or Current Month TOU would be copied over to Prior Month TOU (Accumulated) or Prior Month TOU. Users can set the time in the following format: **DD HH:MM:SS**, where **DD** stands for day, **HH** stands for hour, **MM** stands for minute, **SS** stands for second. Similar to the previous method, once Current Month TOU (Accumulated) is transferred to Prior Month TOU (Accumulated), Current Accumulation Month TOU will continue to accumulate. Once Current Month TOU is transferred to Prior Month TOU, Current Month TOU will be cleared and reset to 0.

4.12 Power Quality Event Logging and Waveform Capture

The Acuvim II meter supports a waveform capture function that allows users to monitor and record power quality events such as voltage swells, voltage sags, and over currents. This is very useful for users that are trying to track slow changing variation in electrical waveforms, and allows them to root out causes of mechanical equipment failure due to these power quality events.

Voltage sags and swells are the reduction(sag) and enlargement(swelling) of voltage over a short time. Voltage sags are the most common events which can affect power quality significantly and are often the most costly. Power quality events such as voltage swells/sags affect equipment ranging from PLCs, relays, controllers and everything in between. When a voltage sag occurs the power supply inside most of these devices become over compensated and could potentially can damage the internal circuits of the device causing malfunctions. Although these are typically blamed on the utility the reality is these are often caused within the site and include grounding, bonding, and coding issues or from powering different equipment from the same supply.

NOTE: *If using 400Hz type Acuvim IIR, event logging and wave capture are not supported.*

4.12.1 Waveform Capture

The waveform capture function in the Acuvim IIW enables users to have the ability to capture 20 cycles of waveforms (10 cycles before and 10 cycles after the event) over three channels and log up to 100 groupings in the meters dedicated internal memory. The Acuvim IIW is the only model of the Acuvim II series that has 16MB of internal memory; 8MB is dedicated for the data logging function and another 8MB is dedicated for capturing power quality events.

The meter’s waveform capture settings can be configured from the Acuvim software in the **Waveform** option under the **Settings** tab. Alternatively, the waveform settings can be configured by via the Modbus registers which are listed in Chapter 6 of the user manual.

DI Triggering Waveform Capture: The Acuvim II meter can be programmed to capture a waveform based on certain Digital Input settings including whether the DI has any change, from ON to OFF, or from OFF to ON.

Table 4-5 - DI Waveform Setting Translation

DI Waveform Setting	DI Channel	I/O Module
DI 111 - DI 116	Digital Input 1-6	AXM-IO1-1
DI 211 - DI 214	Digital Input 1-4	AXM-IO2-1
DI 311 - DI 314	Digital Input 1-4	AXM-IO3-1

NOTE: The DI must be in Digital Status mode in order to be used for waveform triggering.

Rated Voltage: The rated voltage of the system should be entered here. The range is from 50-400V for wye systems or 50-690V for delta systems.

Voltage Swell: When any phase of the three-phase voltage is higher than the set value (voltage rated value x threshold %), there will be a voltage swell event. When a one phase voltage swell happens, the other phase will not respond to voltage swell event logging. Only once all of the phase voltages are restored back to normal will there be a response to a new voltage swell event.

- **Triggering Waveform Capture** - Check this box to enable voltage swell events.
- **Threshold** - Enter in the percentage of the voltage swell to be captured. The range is from 50-140%. For example, if the rated voltage is 277V and the voltage swell threshold is set for 110%, the swell event would be captured when the voltage is 110% above 277V, which is roughly 304V.

Voltage Sag: When any phase of the three-phase voltage is lower than the set value (voltage rated value x threshold %), there will be a voltage sag event. When a one phase voltage sag happens, the other phase will not respond to voltage sag event logging. Only once all of the phase voltages are restored back to normal will there be a response to a new voltage sag event.

- **Triggering Waveform Capture** - Select Enable to capture voltage sag events

- **Threshold** - Enter in the percentage of the voltage sag to be captured. The range is from 20-100%. For example, if the rated voltage is 277V, and the voltage sag threshold is set for 50%, the sag event would be captured when the voltage drops 50% below 277V, which is roughly 138V.
- **Half-cycle Threshold** - Enter in the half cycle threshold for the sag event. The range is from 4-200 half cycles.

NOTE: The rated voltage setting is used for both Voltage Swell and Voltage Sag events

Rated Current: The rated current for the over current should be entered here and the range will be dependent on the CT1 value configured on the meter. The rated current range will be from 50-100% of the CT1 value. For example, if CT1 is configured as 1000A, the rated current range for the Power Quality event is from 500A to 1000A.

Over Current: Will trigger a waveform capture when the current is over the threshold configured. When over-current triggering is enabled, if any phase of the three-phase current is higher than the set value (rated value x threshold %), there will be an over current waveform captured by the Acuvim II meter. If one phase is over-current, any other phase over-current cannot implement the waveform capture. Only when all the phase currents are restored back to normal will waveform capture respond.

- **Triggering Waveform Capture** - Select enable to capture over current events
- **Threshold** - Enter in the percentage of the over current to be captured. The range is from 50-150%. For example, if the rated current is 1000A and the over current threshold is set for 50%, the over current event would be captured when the current is 50% of the rated current, which is 500A

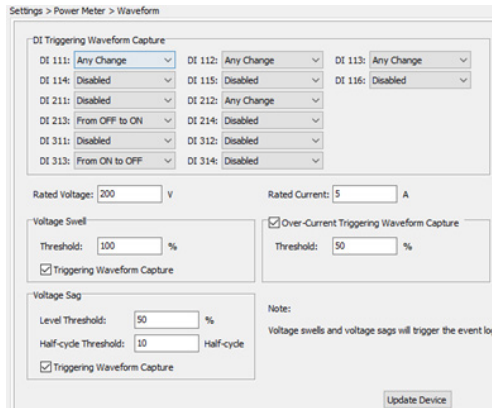

Figure 4-33 - Waveform Capture Settings

4.12.2 Power Quality Event Logging

When a power quality event happens, such as voltage sag and swell, Acuvim IIV will record the event timestamp and the triggering condition. It can save up to 50,000 events. The events can be viewed from Acuvim software in the **Events Log** located under the **Readings** tab.

The event log displays the newest even number and then allows users to view the events by either reading the latest 10 event records, the latest 50 event records, or 1000 records where users can enter in the starting record number. Once the record amount is set from the drop-down menu, click on **Read** to view the records in the event log.

The event log displays the record number, the timestamp (YYYY-MM-DD hh:mm:ss ms format) of when the event occurred, the reason for the event (sag or swell), the voltage rating, and the threshold configured as well as the half cycle configured.

The records can be saved either in text, .csv, or Excel format. Users can also clear the events log from Acuvim.

Once the event log reaches 50,000 events, no more events will be logged even if the triggering condition happens. The user must clear the event log to continue logging power quality events. Once the log is cleared, new events will be logged once an event occurs.

NOTE: The event log does not lose data when the power is shut off.

No.	Time Stamp	ms	Reason	Rating (V)	Threshold (...)	Half-cycle
222	2020-04-09 18:17:39	515	Voltage Sag (A/B)	200	20	10
223	2020-04-09 18:18:13	963	Voltage Swell (A)	200	100	0
224	2020-04-09 18:20:20	569	Voltage Swell (A/B/C)	200	100	0
225	2020-04-09 18:20:42	432	Voltage Swell (A/B/C)	200	100	0
226	2020-04-09 18:21:23	800	Voltage Sag (A/B/C)	200	50	10
227	2020-04-09 18:28:47	796	Voltage Sag (A/B/C)	200	50	10
228	2020-04-14 10:18:47	604	Voltage Sag (A/B/C)	200	50	10
229	2020-05-03 07:23:07	737	Voltage Sag (A/B/C)	200	50	10
230	2020-05-19 00:28:53	140	Voltage Sag (A/B/C)	200	50	10
231	2020-05-22 17:12:31	462	Voltage Sag (A/B/C)	200	50	10

Figure 4-34 - Event Log Records

4.12.3 Waveform Retrieval

Once the power quality event is logged, users can retrieve the waveform from either the Acuvim software or by polling Modbus registers (discussed later in Chapter 6). In the Acuvim software, the waveform can be retrieved from the **Waveform Log** page under the **Readings** tab. Similar to the event log, the waveform log provides users with a log of all power quality events that occurred. Users can navigate and select which waveform record they wish to view, and the waveform can be read by clicking on the **Retrieve Waveform** button.

No.	Time Stamp	ms	Reason	Data
1	2020-03-02 16:35:59	841	Trigger by Voltage Swell (A,B,C)	
2	2020-03-02 17:25:43	108	Trigger by Voltage Swell (A,B,C)	
3	2020-03-02 17:35:18	281	Trigger by Voltage Swell (A,B,C)	
4	2020-03-11 16:48:39	345	Trigger by Voltage Swell (A,B,C)	
5	2020-03-17 08:31:27	648	Trigger by Voltage Swell (A,B,C)	
6	2020-03-17 10:16:22	957	Trigger by Voltage Swell (A,B,C)	
7	2020-03-17 10:41:47	712	Trigger by Voltage Swell (A,B,C)	
8	2020-03-18 09:43:48	883	Manual trigger	

Figure 4-35 - Waveform Log

Users have the option to also manually capture a waveform on the Acuvim II meter, on the Acuvim software click on **Capture Waveform**. This may take 1-2 minutes to capture the waveform, and the waveform will show up in the Waveform Log with Reason description as Manual (refer to record number 8 in Figure 4-35 above). Manual capture allows users to capture and view the voltage and current waveform at any time once the meter is connected to the Acuvim software. This can be useful in comparing normal waveforms of the voltage and current with power quality event waveforms which show either voltage swell, sag or over current.

In the Waveform graph displayed on the Acuvim software, users can select which phases of voltage and current they want to view. The figure below displays only Phase B voltage and current waveforms. The Waveform Capture can log up to 100 groups of waveform data. Once the 100-group data is full, it does not respond to any waveform triggering condition. Only when all the waveform data is reset/emptied will the waveform capturing function resume. When the waveform data is emptied, new waveform data starts from the 1st group.

NOTE: Since the amount of each waveform group data is large, it takes more time to write into the flash memory. Therefore, Waveform Capture only responds to one triggering condition at one time. During the process of writing data into the flash memory, it does not respond to a new triggering condition. After the process of memory writing, it will respond to new waveform triggering conditions.

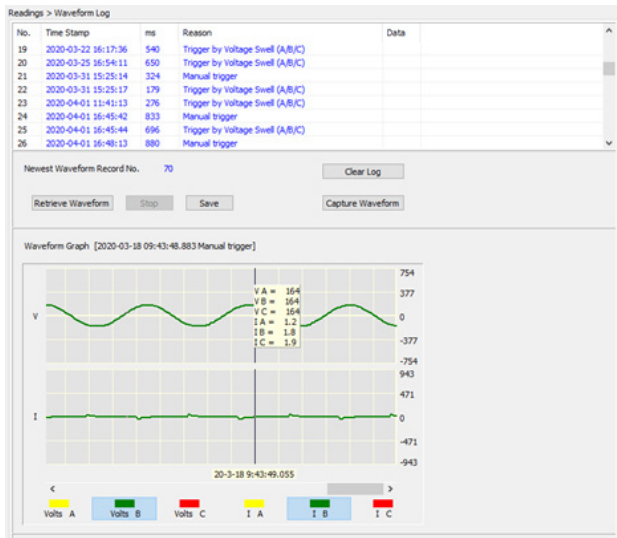

Figure 4-36 - Manual Capture Waveform

Reading the Voltage and Current waveform

When the waveforms are displayed on the Acuvue software, the voltage and current are displayed as peak-to-peak values. In order to view the RMS values, users must convert the peak-to-peak values into RMS.

$$V_{rms} = \frac{V_{peak}}{\sqrt{2}}$$

For example, in Figure 4-37 the voltage for phase B reads 138. Converted to RMS, this value would be 97.58V (which is $138/\sqrt{2}$).

The current is also displayed in peak values where the RMS current is calculated as follows:

$$I_{rms} = \frac{I_{peak}}{\sqrt{2}}$$

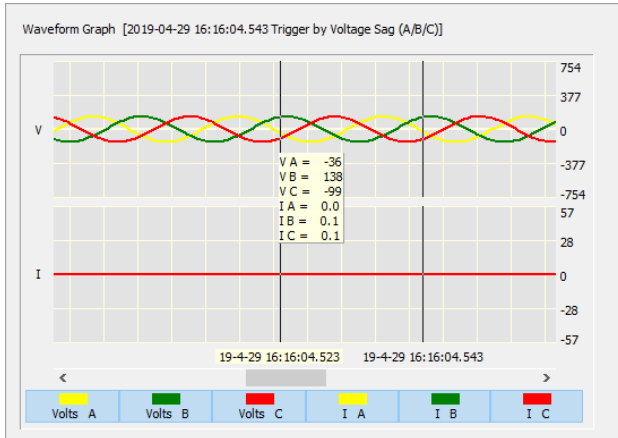

Figure 4-37 - Waveform Capture Retrieval Screen

4.13 Dual Source Energy

The Acuvim II series meters have bi-directional energy capability that allows users to control the direction (Grid/Generator) of the energy accumulation. The user can control the direction either by the Digital Input and through communication. There are two directions in which the energy can be changed to, "Grid" and "Generator".

Users can change the direction of the energy based on the Active Energy, Reactive Energy and Apparent Energy. Below is a table of that represents all options available for this feature.

Table 4-6 Bi-Directional Energy Parameters

Parameters	Config Option
Active Energy	Ep
Phase A Active Energy	Epa
Phase B Active Energy	Epb
Phase C Active Energy	Epc
Reactive Energy	Eq
Phase A Reactive Energy	Eqa
Phase B Reactive Energy	Eqb
Phase C Reactive Energy	Eqc
Apparent Energy	Es
Phase A Apparent Energy	Esa
Phase B Apparent Energy	Esb
Phase C Apparent Energy	Esc

The bi-directional energy function can be enabled in the General Settings on the Acuvim software. Users can select the enabled option and configure the settings accordingly.

Switching Mode: Select the method in which the user wants to change the direction of the energy. Users can change the direction using the Digital Input (DI1-DI28), or they can use "Comm" control which changes the direction via Modbus register write to the control register.

Metering Direction: Can be selected as either "To Grid" or "To Generator".

Energy 1/2/3: Select the energy parameter desired, refer to table 4-6 for parameter list.

Figure 4-38 - Dual Source Energy Settings

4.13.1 Controlling the Energy Direction

There are two methods to control the energy direction, either by communication or by the Digital Input. If the communication method is used, users must write to the Modbus energy direction register, see details of the register below.

Table 4-7 Dual Source Direction Register

Address (H)	Address (D)	Parameter	Range	Data Type	Access Property
1685H	5765	Bi-Directional Energy Direction	0: "To Grid" 1: "To Generator"	Word	R/W

When DI1 ~ DI28 are selected as control input, the direction will be changed when the DI status is ON (High), and will change again when the status changes to OFF (Low). The following table lists the DI mapping from 1-28 with the corresponding I/O modules for the Acuvim II meter.

Table 4-8 DI Mapping for Dual Source Control Input

I/O Module	DI Channel Mapping
AXM-IO11	DI1-DI6
AXM-IO21	DI7-DI10
AXM-IO31	DI11-DI14
AXM-IO12	DI15-DI20
AXM-IO22	DI21-DI24
AXM-IO32	DI25-DI28

4.13.2 Bi-Directional Energy Switching Record

Whenever there is a change in direction for the energy, the Acuvim II meter will keep the historical changes in the Switching Record. The record supports 20 event records, and will overwrite from the earliest entry once the records reach the max amount. Users can reset the switch log and can also reset the dual source energy from Acuvimview.

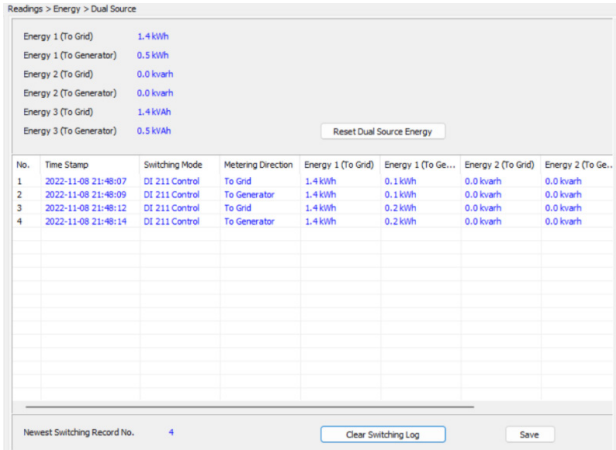

Figure 4-39 - Dual Source Energy Record

4.14 Seal Function

The Acuvim II supports a sealing function where the Acuvim II meter can be electronically sealed to prevent tampering of the meter settings or readings. The seal function can only be configured by writing to the Modbus registers and not from the meters display or Acuvimview software. The register addressing for the seal function can be found in Chapter 6.

When the meter is sealed, some meter functions and certain parameters will be blocked. These parameters will still be accessible from the meter display or by Modbus however, they cannot be changed or modified.

NOTE: By default, the Acuvim II meter is not sealed.

When the meter is in sealed status, the parameters listed in the tables below will be blocked.

Table 4-9 System Parameters Settings blocked in Sealed Status

Parameters	Meter Display Keys	Modbus Communication
Voltage Input Wiring Mode	√	√
Current Input Wiring Mode	√	√
PT1(High 16 bit)	√	√
PT1(Low 16 bit)	√	√
PT2	√	√
CT1	√	√
CT2	√	√
kWh pulse constant	√	√
kvarh pulse constant	√	√
Demand slide window time	√	√
Demand calculating mode	√	√
Clear demand memory	√	√
Current I1 direction	√	√
Current I2 direction	√	√
Current I3 direction	√	√
VAR/PF convention	√	√
Energy clear	√	√
Energy Calculation Mode	√	√
Reactive Power Calculation Method	√	√
Energy Display Mode	√	√
Basic Parameter Mode	√	√
Sealed Nonstandard Parameters Selection	---	√

NOTE: “√” means these addresses will be blocked from the meter’s display keys and Modbus communication. The “-” symbol indicates this function is unavailable.

Table 4-10 Energy Parameters Blocked in Sealed Status:

Parameters	Meter Display Keys	Modbus Communication
Energy IMP	---	√
Energy EXP	---	√
Reactive energy IMP	---	√
Reactive energy EXP	---	√
Energy TOTAL	---	√
Energy NET	---	√
Reactive energy TOTAL	---	√

Parameters	Meter Display Keys	Modbus Communication
Reactive energy NET	---	√
Apparent energy	---	√
Phase A Energy IMP	---	√
Phase A Energy EXP	---	√
Phase B Energy IMP	---	√
Phase B Energy EXP	---	√
Phase C Energy IMP	---	√
Phase C Energy EXP	---	√
Phase A Reactive energy IMP	---	√
Phase A Reactive energy EXP	---	√
Phase B Reactive energy IMP	---	√
Phase B Reactive energy EXP	---	√
Phase C Reactive energy IMP	---	√
Phase C Reactive energy EXP	---	√
Phase A Apparent energy	---	√
Phase B Apparent energy	---	√
Phase C Apparent energy	---	√

Table 4-11 Digital Output Parameters blocked in Sealed Status

Parameters	Meter Display Keys	Modbus Communication
Working mode of DO1 and DO2	√	√
DO pulse width	√	√
DO1 output	√	√
DO2 output	√	√
Working mode of DO3 and DO4	√	√
DO pulse width	√	√
DO3 output	√	√
DO4 output	√	√

4.14.1 Sealed Nonstandard Parameters

The following parameters are not sealed when the meter is in Sealed Status. However, they can be manually configured to be sealed. These non-standard parameters can be sealed from either the Acuvim software or by writing to the Modbus registers. From the Acuvim software, sealing can be configured from the **General** page under the **Settings** tab.

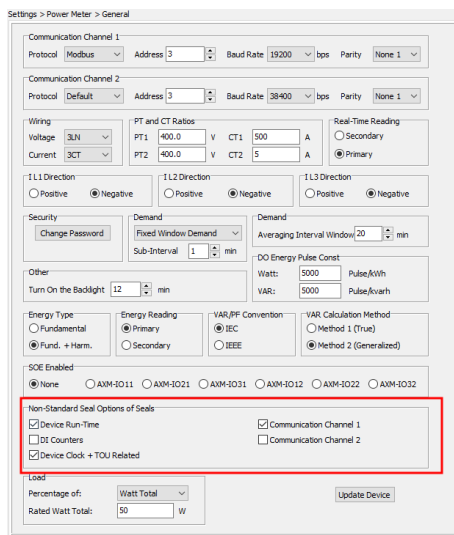

Figure 4-40 - Sealed Nonstandard Parameter Configuration

There are five categories that can be optionally sealed:

- Device Run Time
- DI Counters
- Device Clock & TOU
- Communication Channel 1
- Communication Channel 2

The following tables explain what functions are blocked if any of these are selected to be sealed.

Table 4-12 Run Time Clear in Sealed Status

Parameters	Meter Display Keys	Modbus Communication
Run time clear	√	√

Table 4-13 DI Counter Functions Blocked in Sealed Status

Parameters	Meter Display Keys	Modbus Communication
Pulse counter clear	√	√
DI1-6 type	√	√

Parameters	Meter Display Keys	Modbus Communication
DI pulse constant	√	√
DI7-10 type	√	√
DI pulse constant	√	√
DI11-14 type	√	√
DI pulse constant	√	√
DI15-20 type	√	√
DI pulse constant	√	√
DI21-24 type	√	√
DI pulse constant	√	√
DI25-28 type	√	√
DI pulse constant	√	√

Table 4-14 TOU Functions blocked in Sealed Status

Parameters	Meter Display Keys	Modbus Communication
TOU		
Ten years of download setting enabled	---	√
Fee of sharp demand clear	---	√
Fee of peak demand clear	---	√
Fee of valley demand clear	---	√
Fee of normal demand clear	---	√
Total fee of demand clear	---	√
Current and last month TOU energy		
Current and last month TOU energy	---	√
DST setting		
DST setting	---	√
Season setting		
Basis parameter of TOU	---	√
Season setting	---	√
Ten years of holiday setting		
Ten years of holiday setting	---	√

Table 4-15 Communication Channel 1 Sealed Parameters

Parameters	Meter Display Keys	Modbus Communication
Run time clear	√	√
Parity Setting 1	√	√
Communication Address 1	√	√

Table 4-16 Communication Channel 2 Sealed Parameters

Parameters	Meter Display Keys	Modbus Communication
Baud rate 2	√	√
Parity setting 2	√	√
Communication address 2	√	√
Ethernet Module		
DHCP setting	√	√
IP address 1st byte (high)	√	√
IP address 2nd byte (low)	√	√
IP address 3rd byte (high)	√	√
IP address 4th byte (low)	√	√
Submask 1st byte (high)	√	√
Submask 2nd byte (low)	√	√
Submask 3rd byte (high)	√	√
Submask 4th byte (low)	√	√
Gateway 1st byte (high)	√	√
Gateway 2nd byte (low)	√	√
Gateway 3rd byte (high)	√	√
Gateway 4th byte (low)	√	√
DNS1 1st byte (high)	√	√
DNS1 2nd byte (low)	√	√
DNS1 3rd byte (high)	√	√
DNS1 4th byte (low)	√	√
DNS2 1st byte (high)	√	√
DNS2 2nd byte (low)	√	√
DNS2 3rd byte (high)	√	√
DNS2 4th byte (low)	√	√
Modbus TCP/IP port	√	√
HTTP port	√	√
BACnet Module		
BACnet module enable	√	√
DHCP setting	√	√
IP address 1st byte (high)	√	√
IP address 2nd byte (low)	√	√
IP address 3rd byte (high)	√	√
IP address 4th byte (low)	√	√
Submask 1st byte (high)	√	√
Submask 2nd byte (low)	√	√
Submask 3rd byte (high)	√	√
Submask 4th byte (low)	√	√

Parameters	Meter Display Keys	Modbus Communication
Gateway 1st byte (high)	√	√
Gateway 2nd byte (low)	√	√
Gateway 3rd byte (high)	√	√
Gateway 4th byte (low)	√	√
DNS1 1st byte (high)	√	√
DNS1 2nd byte (low)	√	√
DNS1 3rd byte (high)	√	√
DNS1 4th byte (low)	√	√
DNS2 1st byte (high)	√	√
DNS2 2nd byte (low)	√	√
DNS2 3rd byte (high)	√	√
DNS2 4th byte (low)	√	√
MAC address	√	√
BACnet baud rate	√	√
Max info frames	√	√
BACnet Port	√	√
PROFIBUS Module		
PROFIBUS address	√	√

Chapter 5: Extended Modules

5.1 I/O Modules

The standard Acuvim II meter base does not have any built-in I/O functions. However, with the addition of the extended modules, multiple I/O options can be added. These functions include digital input status, pulse counter, relay output, analog output, and analog input. These I/O functions can be useful for a variety of metering applications such as counting/outputting pulse signals to/from water/gas meters, outputting 4-20mA analog signals to a PLC controller, or measuring the analog signal from a temperature sensor.

The Acuvim II series supports three types of I/O modules: the AXM-IO1, AXM-IO2 and AXM-IO3. There is a maximum of three external modules that can be attached to the Acuvim II meter, and this includes communication modules. If users have communication modules with I/O modules, the communication module is required to be installed on to the meter first, followed by the I/O modules. There can be no more than two of the same type of I/O module attached to the meter and, if there are two of the same type of I/O module connected to the meter, they must have a unique logic number. For example, if a user wants two AXM-IO2 modules, they will need to designate an AXM-IO2-1 and an AXM-IO2-2. In this case, the logic numbers for the modules are 1 and 2, respectively.

NOTE: When using a communications module with an I/O module, ensure that the communications module is installed on to the meter first.

5.1.1 Appearance and Dimensions

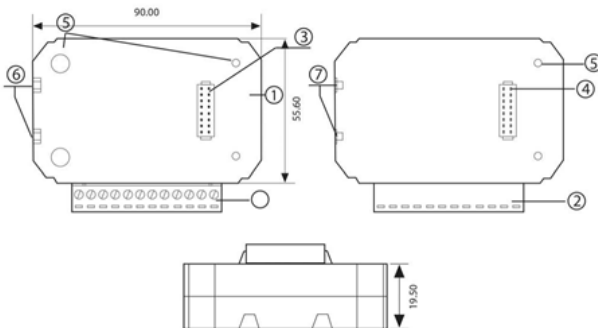

Figure 5-1 I/O Module Dimensions

Table 5-1 I/O Module Description Table

Number	Description
1	Enclosure
2	Wiring Terminals
3	Linking Pins
4	Linking Socket
5	Installation Screw
6	Counterpart of Clip
7	Installation Clip

5.1.2 I/O Functionality

The **AXM-IO1** module is composed of:



Figure 5-2 AXM-IO1 Module

- **6 Digital Inputs (DI)**

- Each digital input can be used in pulse counter or digital status mode. In digital status mode, the DI will be used to detect remote signals and the meter will log the time/date of the detection and store it in the SOE (sequence of events) log of the Acuvim II, if enabled. In pulse counter mode, the DI will be used to count digital pulses.
- Terminals **DI1** to **DIC** are the Digital Input terminals, where DIC is the common terminal for DI1-DI6 circuits.

- **2 Relay Outputs (RO)**

- The relay outputs can be used in two different modes, control mode or alarm mode, where both relays channels operate in the same mode. In control mode, users can configure the relay to work in either latch mode (ON/OFF) or momentary mode (ON/OFF for a certain time interval). When it operates in alarm mode, the relay will turn ON/OFF based on the status on the alarm configured in the Acuvim II meter.
- Terminals **RO1** to **ROC** are the Relay Output terminals, where ROC is the common terminal

for RO1 and RO2 circuits.

- **24Vdc Power Supply**

- Used as an auxiliary power supply for the digital input pulse circuits.
- The voltage of the DI auxiliary power supply is 24V(1W).
- Terminals **V+** and **V-** are the terminals for the 24Vdc power supply.

The **AXM-IO2** module is composed of:



Figure 5-3 AXM-IO2 Module

- **4 Digital Inputs (DI)**

- Each digital input can be used in pulse counter or digital status mode. In digital status mode, the DI will be used to detect remote signals where the meter will log the time/date of the detection and store it in the SOE (sequence of events) log of the Acuvim II, if enabled. In pulse counter mode, the DI will be used to count digital pulses.
- Terminals **DI1** to **DIC** are the Digital Input terminals, where DIC is the common terminal for DI1-DI4 circuits.

- **2 Analog Outputs (AO)**

- Depending on the model the AXM-IO2 can output an analog voltage or analog current based on certain parameters measures by the Acuvim II meter.
 - When it outputs analog voltage, the range of voltage is from 0 to 5V or from 1 to 5V.
 - When it outputs analog current, the range of current is from 0 to 20mA or from 4 to 20mA.
- Terminals **AO1+** to **AO2-** are the Analog Output terminals.

NOTE: The AXM-IO2 module can only output one type of analog signal.

- **2 Digital Outputs (DO)**

- The digital output can be used in either alarm mode or energy pulse output mode and both DO channels will operate in the same mode. In energy pulse mode, the DO will send digital pulses based on various types of energy (consumed/generated or real/reactive) reading

measured by the Acuvim II meter. In alarm mode, the DO will output a digital pulse when an alarm is triggered.

- Terminals **DO1** to **DOC** are the Digital Output terminals, where DOC is the common terminals for DO1 and DO2.

The **AXM-IO3** module is composed of:



Figure 5-4 AXM-IO3 Module

- **4 Digital Inputs (DI)**

- Each digital input can be used in pulse counter or digital status mode. In digital status mode, the DI will be used to detect remote signals and the meter will log the time/date of the detection and store it in the SOE (sequence of events) log of the Acuvim II, if enabled. In pulse counter mode, the DI will be used to count digital pulses.
- Terminals **DI1** to **DIC** are the Digital Input terminals, where DIC is the common terminal for DI1-DI4 circuits.

- **2 Relay Outputs (RO)**

- The relay outputs can be used in two different modes, control mode or alarm mode, where both relay channels operate in the same mode. In control mode, users can configure the relay to work in either latch mode (ON/OFF) or momentary mode (ON/OFF for a certain time interval). When it operates in alarm mode, the relay will turn ON/OFF based on the status on the alarm configured in the Acuvim II meter.
- Terminals **RO1** to **ROC** are the Relay Output terminals, where ROC is the common terminal for RO1 and RO2 circuits.

- **2 Analog Inputs (AI)**

- Can detect input analog voltage or analog current.
 - When it detects input analog voltage, the range of voltage is from 0 to 5V or from 1 to 5V.
 - When it detects input analog current, the range of current is from 0 to 20mA or from 4 to 20mA.
- Terminals **AI1+** to **AI2-** are the Analog Input terminals.

NOTE: The AXM-IO3 can only read input from one type of analog signal.

Table 5-2 I/O Module Functionality Table

Functions	AXM-IO1	AXM-IO2	AXM-IO3
Detection of remote signals	•	•	•
SOE Recording	•	•	•
Pulse Counting	•	•	•
Relay Control	•		•
Relay Control by Alarm	•		•
Digital Output by Alarm		•	
Digital Pulse Output		•	
Analog Output		•	
Analog Input			•
24Vdc Power Supply	•		

5.1.3 Installation Method

Environment

Please verify that the installation environment meets the following requirements:

Temperature:

Operation: -25°C to 70°C

Storage: -40°C to 85°C

Humidity:

5% to 95% non-condensing

Location:

The AcuVim II meter and I/O modules should be installed in a dry, dust-free environment away from heat, radiation, and high electrical noise/interference.

Installation Method:

Remove the **Ext. Port** cover from the back of the meter and any I/O module so that the linking pins are visible.



Figure 5-5 External Port Cover

NOTE: Use a small, flat, thin screwdriver to remove the external port cover from the back of the meter.

1. Insert the counterpart clips of the module into the Acuvim II meter and then press the module down lightly to establish the linking.
2. Tighten the installation screws.
3. Install other modules using the steps above.

NOTE: Install modules carefully to avoid damage. Under no circumstances should any installation be done with the meter powered on. Failure to do so may cause damage to the meter.

NOTE: The maximum number of modules that can be attached to the meter is three. Ensure that any communication modules are installed prior to installing any I/O modules.

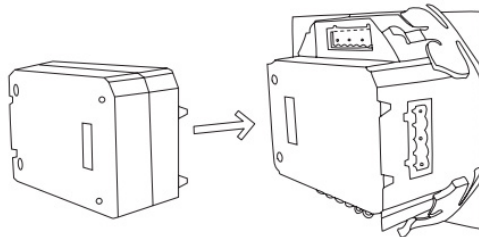

Figure 5-6 Installation of IO module to Acuvim II meter

5.1.4 I/O Module Wiring

Digital Input

Wiring of Digital Input Circuit:

There are six DI channels in the AXM-IO1 and four DI channels in the AXM-IO2 and AXM-IO3 modules. The Digital Input circuits within each of the modules are the same for both pulse counter and digital status modes. The digital input circuitry is described in Figure 5-6 below. From the wiring schematic, when K is open, OUT is in high state. When K is closed, OUT is in the low state.

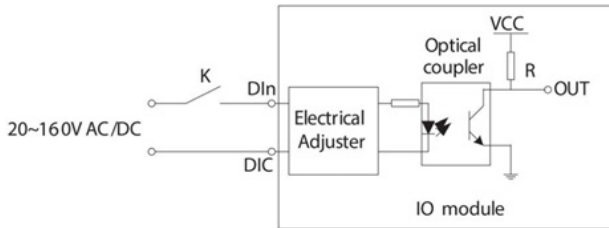

Figure 5-7 Digital Input Wiring Schematic

Digital Input ratings:

- External Power Supply Rating: 20-160Vac/Vdc
- Maximum loop current: 2mA
- Start Voltage: 15V
- Stop Voltage: 5V
- Max Pulse Frequency: 100Hz, 50% Duty Cycle (5ms ON and 5ms OFF)

Typical Digital Input Wiring

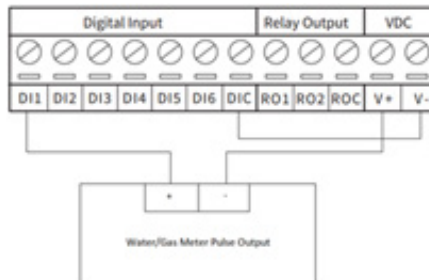

Figure 5-8 Digital Input pulse counter wiring using 24Vdc on AXM-IO1 module

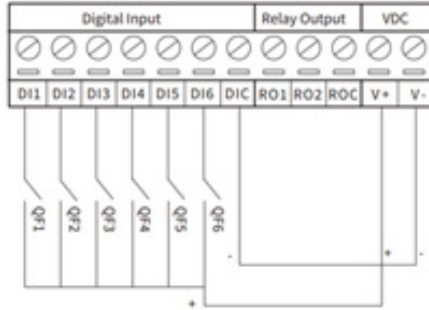

Figure 5-9 Multiple channel Digital Input wiring using 24Vdc on AXM-IO1 module

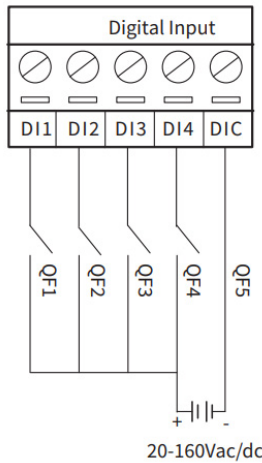

Figure 5-10 Digital Input Wiring Using AXM-IO2 and AXM-IO3 Modules

NOTE: The wire gauge to use with the DI should be between AWG22~16.

Relay Output

There are two Relay Output channels in the AXM-IO1 and AXM-IO3 modules. The RO circuits can work in either control mode or alarm mode. The following diagram shows the schematic of the relay output circuit, which is the same regardless of the operating mode.

The relay type is a mechanical form A contact with 3A/250Vac or 3A/30Vdc. When using the relay output, it is recommended that an intermediate relay is used to control the output device.

Relay Output ratings:

- **Switching Voltage (Max):** 250Vac, 30Vdc
- **Load Current:** 5A (R), 2A (L)
- **Set Time:** 10ms (Max)
- **Contact Resistance:** 30mΩ (Max)
- **Isolation Voltage:** 2500Vac
- **Mechanical Life:** 1.5e7

Typical Relay Output Wiring

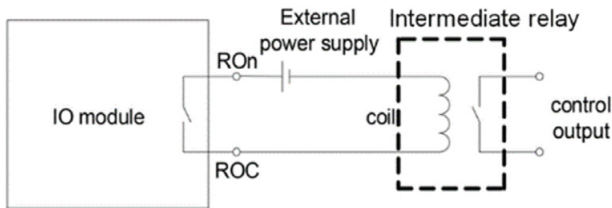

Figure 5-11 Relay Output Diagram

NOTE: The wire gauge to use with the relay output should be between AWG22~16.

Digital Output

There are two Digital Output channels on the AXM-IO2 module. The DO circuit can operate in either alarm mode or in energy pulse output mode.

The DO circuit is of Photo-MOS form. The simplified circuit is shown in Fig 5-11.

Digital Output ratings:

- **Voltage Range:** 0-250Vac/dc
- **Load Current:** 100mA (Max)
- **Output Frequency:** 25Hz, 50% Duty Ratio (20ms ON, 20ms OFF)
- **Isolation Voltage:** 2500Vac

Wiring of Digital Output Circuit

When the internal signal J is in the low state, OUT is also in a low state and, therefore, there is no pulse output. When J is in a high state, OUT is in the high state which will then output a pulse.

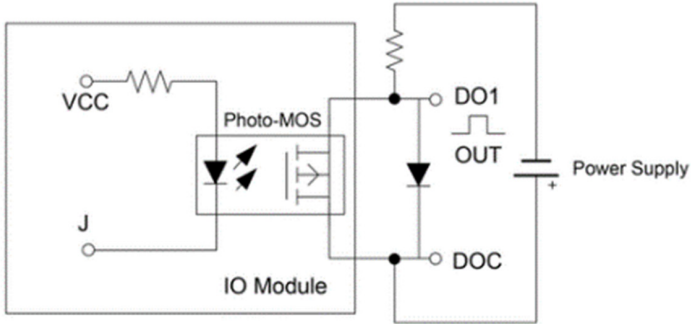

Figure 5-12 Digital Output Circuit

NOTE: The Digital Output is a dry contact and requires a voltage supply in order to generate the pulse signal.

The circuit for the alarm mode with a buzzer is shown in Figure 5-12.

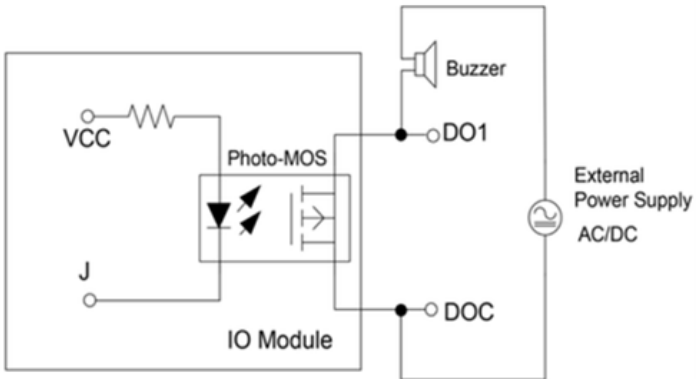

Figure 5-13 Digital Output as Alarm Mode

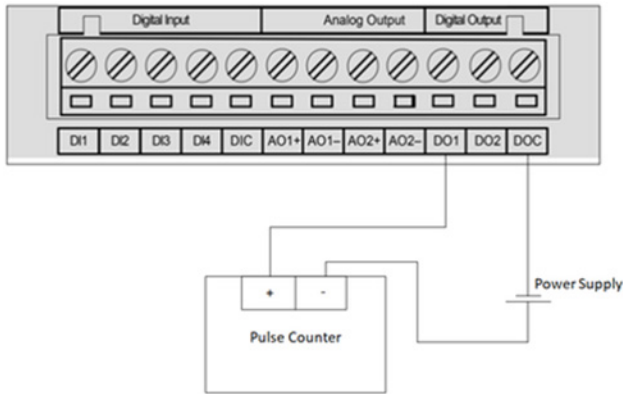

Figure 5-14 Digital Output to a pulse counter

NOTE: The power supply can be 0-250Vac/dc.

NOTE: The wire gauge to use for the DO should be between AWG22-16.

Analog Output

There are two Analog Output channels on the AXM-IO2 module. The AO circuit can convert metering parameters into an AO signal as either a voltage or current signal. One AXM-IO2 module supports either voltage or current where the AO circuit can provide either a 0-20mA or 4-20mA output or it can provide a 0-5V and 1-5V output.

Wiring of Analog Output Circuit:

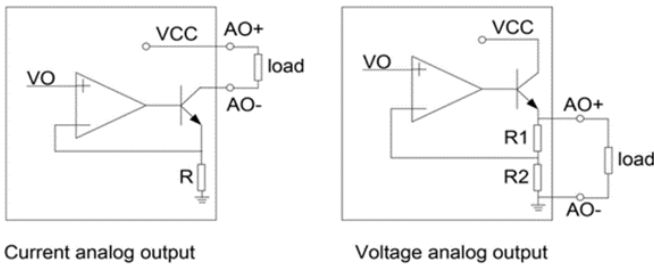

Figure 5-15 Analog Output circuit for voltage and current on AXM-IO2 module

Analog Output Ratings:

- **For the current output (0-20mA/4-20mA):** The max load resistance is 500Ohms.
- **For the voltage output (0-5V/1-5V):** The max load current is 20mA.
- **Accuracy:** 0.5%
- **Temperature Drift:** 50ppm/°C Typical
- **Isolation Voltage:** 500Vdc
- **Open Circuit Voltage:** 15V

Analog Input

Wiring of Analog Input Circuit:

There are two Analog Input channels on the AXM-IO3 modules. One AXM-IO3 module supports either voltage or current. The AI circuit can provide either a 0-20mA or 4-20mA input or it can provide a 0-5V and 1-5V input.

The simplified circuit is as shown in Fig 5-15

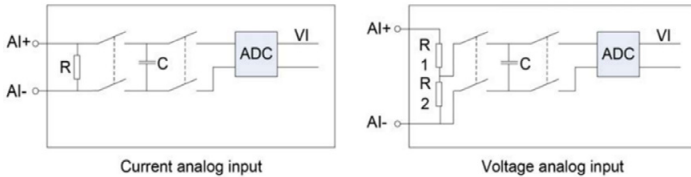

Figure 5-16 Analog Input Circuit for Voltage and Current on the AXM-IO3 Module

5.1.5 IO Module Readings

5.1.6 Detection of Remote Signals

By default, the Digital Input on all I/O modules are configured in **State** mode, where the meter provides a digital signal status (ON/OFF). When the DI circuit detects a sufficient voltage input, it will show a **1** on the screen and **ON** from the Acuvim software. Otherwise, it will show a **0** on the screens and **OFF** on the software.

Viewing the Digital status from the Meters Display:

- Press **H** and **V/A** at the same time. The screen will go blank, and Meter will begin flashing.
- Press the **P** or **E** button to move the flashing cursor over to Digital I/O and press **V/A** to enter.
- Next, users will see the I/O selection screen, select the appropriate I/O module and press **V/A**.
- With the cursor on **DI**, press **V/A** to view the Digital Input Status readings.

NOTE: Refer to Chapter 3 section 3.7.4 on how to configure the DI from the meter's display.

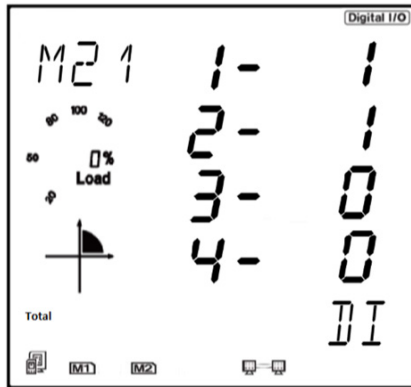

Figure 5-17 Digital Status Reading from Acuvim II Display

Viewing the Digital status from the Acuvim software:

The Digital Input mode can be configured from the Acuvim software, on the **I/O Modules *1**, or **I/O Modules *2** page under the **Settings** tab. The difference between I/O pages 1 and 2 is the module's logic number. For example, if users have an AXM-IO3-2, they will configure the settings on I/O Modules*2.

Acuvim II Series Power Meter

The DI settings must be set to **State** to monitor the Digital Status. If any changes are made to the I/O settings, click on **Update Device** at the bottom of the Settings page in order to save the configurations.

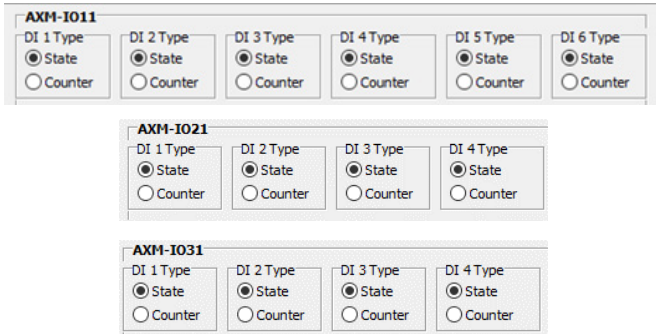

Figure 5-18 Digital Input Status Configuration

Under the **Readings** tab select either **I/O Modules *1** or **I/O Modules *2** depending on the I/O module's logic number. From there, users can see the digital input status on the software as either **ON** or **OFF**. Figure 5-18 shows the status of an AXM-I02-1 module, where channels 1 and 2 have the status as ON and channels 3 and 4 have the status as OFF.

NOTE: AXM-I011, AXM-I021, and AXM-I031 have logic number of 1. AXM-I012, AXM-I022, and AXM-I032 have logic number of 2.

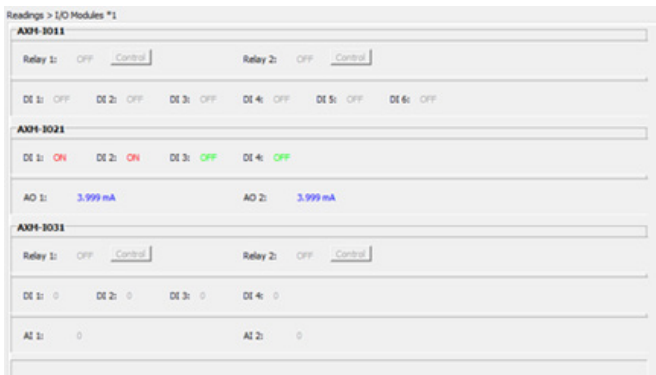

Figure 5-19 Digital Input Status Readings from the Acuvim Software

Sequence of Events Record (SOE)

When the Digital Input is configured to detect remote signals, users have the option to monitor the digital status change using the sequence of events log on the Acuvim II meter. Users can select which I/O module to log from the **General** page under the **Settings** tab on the software. The SOE can also be enabled from the meter's display in the system settings of the Acuvim II meter. Refer to Chapter 3 of the manual for more details on configuring the settings from the display.

Users can select which module to record the status change events or can disable the SOE function by selecting **None**.

Settings > Power Meter > General

Communication Channel 1
 Protocol: Modbus | Address: 1 | Baud Rate: 19200 bps | Parity: None 1

Communication Channel 2
 Protocol: Default | Address: 1 | Baud Rate: 38400 bps | Parity: None 1

Wiring: Voltage: 2LL | Current: 3CT

PT and CT Ratios
 PT1: 400.0 V | CT1: 1000 A
 PT2: 400.0 V | CT2: 100 mV

Real-Time Reading
 Secondary
 Primary

I L1 Direction: Positive Negative
 I L2 Direction: Positive Negative
 I L3 Direction: Positive Negative

Security: Change Password

Demand: Fixed Window Demand | Sub-Interval: 1 min

Averaging Interval Window: 15 min

Other: Turn On the Backlight: 10 min

DO Energy Pulse Const
 Watt: 2500 Pulse/kWh
 VAR: 2500 Pulse/kvarh

Energy Type: Fundamental Fund. + Harm.
 Energy Reading: Primary Secondary
 VAR,PF Convention: IEC IEEE
 VAR Calculation Method: Method 1 (True) Method 2 (Generalized)

SOE Enabled
 None AXM-IO11 AXM-IO21 AXM-IO31 AXM-IO12 AXM-IO22 AXM-IO32

Non-Standard Seal Options of Seals
 Device Run-Time Communication Channel 1
 DI Counters Communication Channel 2

Load
 Percentage of: Current
 Rated Watt Total: 1 W

Update Device

Figure 5-20 SOE Enable configuration

SOE Records

The Sequence of Events log can record up to 20 events. When more than 20 events have been recorded, the SOE will overwrite the oldest record and continue recording. The SOE record includes the status from DI1-DI6 as well as the timestamp for when the change occurred.

Acuvim II Series Power Meter

When the Acuvim II series meter is powered, the SOE will begin to record immediately. The data in the SOE Log is saved when the meter is powered down.

When a new I/O module is selected to be recorded from, the records will be overwritten immediately.

The SOE log can be read from the Acuvim software by selecting the **SOE Log** under the **Readings** tab.

NOTE: The Acuvim II meter will only log SOE events when the DI is configured for Status mode. If the DI is configured for pulse mode, there will be no change in the SOE Log.

No.	Time Stamp	ms	DI 1	DI 2	DI 3	DI 4	DI 5	DI 6
1	2020-05-22 15:59:20	959	ON	OFF	OFF	OFF	OFF	OFF
2	2020-05-22 16:01:53	779	OFF	OFF	OFF	OFF	OFF	OFF
3	2020-06-03 11:37:46	505	ON	OFF	OFF	OFF	OFF	OFF
4	2020-06-03 11:37:46	785	ON	ON	OFF	OFF	OFF	OFF
5	2020-06-03 11:37:58	227	ON	OFF	OFF	OFF	OFF	OFF
6	2020-06-03 11:37:58	469	OFF	OFF	OFF	OFF	OFF	OFF
7	2020-06-03 11:38:21	448	ON	OFF	OFF	OFF	OFF	OFF
8	2020-06-03 11:38:22	6	ON	ON	OFF	OFF	OFF	OFF
9	2020-06-03 11:38:27	165	OFF	ON	OFF	OFF	OFF	OFF
10	2020-06-03 11:38:27	369	OFF	OFF	OFF	OFF	OFF	OFF
11	2020-06-03 11:39:11	535	ON	OFF	OFF	OFF	OFF	OFF
12	2020-06-03 11:39:13	358	ON	ON	OFF	OFF	OFF	OFF
13	2020-06-03 11:40:42	923	OFF	ON	OFF	OFF	OFF	OFF
14	2020-06-03 11:40:43	277	OFF	OFF	OFF	OFF	OFF	OFF
15	0001-01-01 00:00:00	0	OFF	OFF	OFF	OFF	OFF	OFF
16	0001-01-01 00:00:00	0	OFF	OFF	OFF	OFF	OFF	OFF
17	0001-01-01 00:00:00	0	OFF	OFF	OFF	OFF	OFF	OFF
18	0001-01-01 00:00:00	0	OFF	OFF	OFF	OFF	OFF	OFF

Newest SOE Record No. 14
SOE Records from AXM-1021

Save

Figure 5-21 SOE Log Readings

5.1.7 Pulse Counter

The DI channels can also be configured to count pulses. Once the appropriate DI channel is configured to count pulses, the meter will be able to show this count on the meter display or from the Acuvim software.

Viewing the Digital Input pulse count from the Meters Display:

- Press **H** and **V/A** at the same time. The screen will go blank, and **Meter** will begin flashing.
- Press the **P** or **E** button to move the flashing cursor over to **Digital I/O** and press **V/A** to enter.
- Next, users will see the I/O selection screen. Select the appropriate I/O module and press **V/A**.
- Press either **P** or **E** to move the cursor down to **CTR** and press **V/A** to view the Digital Input Pulse Counter readings.
- Once on the Counter page, press **P** or **E** to navigate between different counters.

NOTE: Refer to section 3.7.4 in Chapter 3 for directions for configuring the DI from the meter's display.

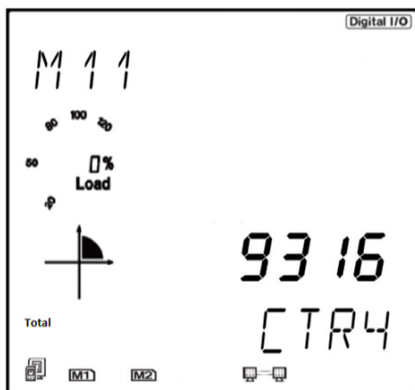

Figure 5-22 Digital Input Pulse Count from meters display

NOTE: The counter value is read from top to bottom on the meter display. For example, if the count value is 123456789, it will be displayed on the meter as 1 on the top line, 2345 on the second line, and 6789 on the bottom line.

How to view and configure the Pulse Input from the Acuvview software:

The Digital Input can be configured as Pulse Counter on the *I/O Modules *1* or *I/O Modules *2* page depending on the logic number of the module being configured. The DI mode must be set to **Counter** for the Digital Input to count the pulse signals. Users can also configure the pulse counter constant. This number represents how many pulses will equate to 1 count on the Digital Input; the range is from 1-65535.

AXM-1011					
DI 1 Type <input type="radio"/> State <input checked="" type="radio"/> Counter	DI 2 Type <input type="radio"/> State <input checked="" type="radio"/> Counter	DI 3 Type <input type="radio"/> State <input checked="" type="radio"/> Counter	DI 4 Type <input type="radio"/> State <input checked="" type="radio"/> Counter	DI 5 Type <input type="radio"/> State <input checked="" type="radio"/> Counter	DI 6 Type <input type="radio"/> State <input checked="" type="radio"/> Counter
RO Type <input checked="" type="radio"/> Relay Control <input type="radio"/> Alarm	RO Relay Control Output Mode <input checked="" type="radio"/> Latch <input type="radio"/> Momentary On Time: 50 ms			DI Pulse Const 1 Pulse = 1	
AXM-1021					
DI 1 Type <input type="radio"/> State <input checked="" type="radio"/> Counter	DI 2 Type <input type="radio"/> State <input checked="" type="radio"/> Counter	DI 3 Type <input type="radio"/> State <input checked="" type="radio"/> Counter	DI 4 Type <input type="radio"/> State <input checked="" type="radio"/> Counter	DI Pulse Const 1 Pulse = 1	
AXM-1031					
DI 1 Type <input type="radio"/> State <input checked="" type="radio"/> Counter	DI 2 Type <input type="radio"/> State <input checked="" type="radio"/> Counter	DI 3 Type <input type="radio"/> State <input checked="" type="radio"/> Counter	DI 4 Type <input type="radio"/> State <input checked="" type="radio"/> Counter	DI Pulse Const 1 Pulse = 1	

Figure 5-23 Pulse Counter configuration from Acuvview software

The DI pulse count data can be read on the Acuvview software from the **Readings** tab by selecting either *I/O Modules *1* or *I/O Modules *2* depending on the logic address of the module that is connected to the meter.

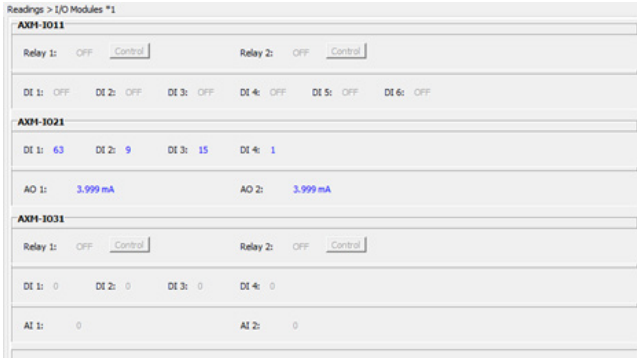

Fig 5-24 Pulse Counter Readings from the Acuvim software

Scaling Pulse Count Values

The pulse count can be scaled from the Acuvim software. This allows users to scale or multiply the raw pulse count values and can be useful when converting pulse counts from a water or gas meter. To configure, go to **Pulse Input** under the **Settings tab**. From here, users will have the option to configure the Name, the Category, unit, and ratio multiplier.

Users can select the options from the drop-down menu under Category and Unit. However, if the required category/unit is not available, users can create their own by clicking on the **Advanced Options** button at the bottom of the page. Refer to Figure 5-24 for the Advanced Options.

Once all values have been entered, click on **Apply** to save the settings.

DI Name	DI Type	Name	Category	Unit	Ratio
DI_111	State				1
DI_112	State				1
DI_113	State				1
DI_114	State				1
DI_115	State				1
DI_116	State				1
DI_211	Counter	Water Meter 1	Water	mL	0.5
DI_212	Counter	Gas Meter	Gas	m3	0.33
DI_213	Counter	Counter	Energy	\$	12
DI_214	Counter	Test		kWh	1
DI_311	Counter				1
DI_312	Counter				1

Figure 5-25 Pulse Input Scaling from Acuvim software

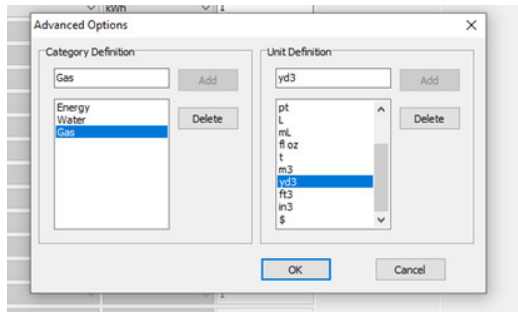

Figure 5-26 Pulse Category/Unit configuration

To view the scaled pulse input readings, go to **Real-Time** under **Energy** in the **Readings** tab. The multiplied pulse count values will be displayed in the Pulse Input table.

Pulse Input			
Name	Category	Reading	Unit
Water Meter 1	Water	31.5	mL
Gas Meter	Gas	2.97	m ³
Counter	Energy	100	\$
Test		1	kWh

Figure 5-27 Scaled Pulse Input Readings

NOTE: These scaled readings will only be displayed on the Acuvision software. The readings from the meter's display, Modbus registers, and I/O readings page on Acuvision will only display the raw count value.

Clearing the Pulse Count

The pulse count can be cleared from the meter's display, Acuvision software, or by Modbus registers. For directions on how to clear the pulse count using the meter's display, refer to Chapter 3. For Modbus directions, refer to Chapter 6.

To clear the pulse count from the Acuvision software, go to the **Pulse Input** page under the **Settings** tab. At the bottom of the page, use the drop-down menu to select which I/O module DI count to clear. Once selected, click on **Reset DI Counters**.

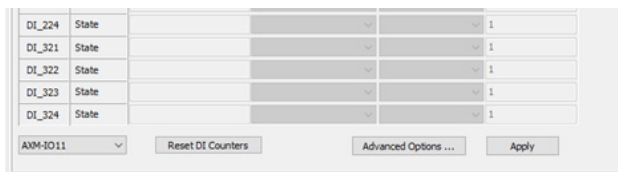

Figure 5-28 Reset DI Counter from Acuvision software

5.1.8 Relay Output

The relay output is supported on the AXM-IO1 and AXM-IO3 modules. Users can read the relay output status from either the meter’s display, Acuvim software, or through Modbus registers.

Reading Relay Output from Meter Display:

- Press **H** and **V/A** at the same time. The screen will go blank and **Meter** will begin flashing.
- Press the **P** or **E** button to move the flashing cursor over to **Digital I/O** and press **V/A** to enter.
- Next users will see the I/O selection screen, select the appropriate I/O module and press **V/A**.
- Press either **P** or **E** to move the cursor down to **RO** and press **V/A** to view the Digital Input Pulse Counter readings.

By default, the relay will be in **OFF** state (normally open). When the relay output is triggered, the relay status will switch to **ON**.

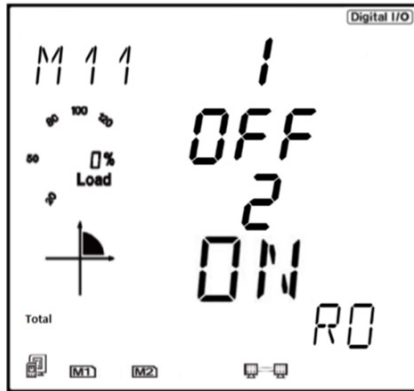

Figure 5-29 Relay Output Status Readings

How to view and configure the Relay Output from the Acuvim software:

The Relay Output settings can be configured from the Acuvim software on the **I/O Modules *1** or **I/O Modules *2** page under the **Settings** tab depending on the logic number of the I/O module being used. There are two RO types that the module can be configured as:

- **Relay Control:** When configured as relay control, users can manually switch the relay ON/OFF. There are two additional modes, if the relay is set for Relay Control: Latch and Momentary.

- **Latch:** When the control mode is set for Latch, the relay will only be switched ON/OFF manually by the user.
- **Momentary:** When the control mode is set for Momentary, the relay will only switch ON for certain time period which can be configured by user. The range for this time period is from 50-3000ms.
- **Alarm:** When configured as alarm, the relay will switch ON/OFF based on the alarm condition set in the Acuvim II meter. Users can configure a certain alarm to trigger the relay if its value is over/under a certain condition.



Figure 5-30 Relay Output Configuration from Acuvim Software

Settings > Power Meter > Alarm

Enable Alarm Enable Backlight Flashing Update Device

Limit ID	Enable	Alarm Channel	Setting	Setpoint	Delay (ms)	AND	DO211	DO212	DO221	DO222	DO***
#1	<input checked="" type="checkbox"/>	Frequency (Hz)	<	60	0	<input type="checkbox"/>	<input type="checkbox"/>	<input type="checkbox"/>	<input type="checkbox"/>	<input type="checkbox"/>	112
#2	<input checked="" type="checkbox"/>	Watt A (kW)	>	250.0	0	<input type="checkbox"/>	<input type="checkbox"/>	<input type="checkbox"/>	<input type="checkbox"/>	<input type="checkbox"/>	111
#3	<input type="checkbox"/>	Volts AN (V)	>	100.0	0	<input type="checkbox"/>	<input type="checkbox"/>	<input type="checkbox"/>	<input type="checkbox"/>	<input type="checkbox"/>	
#4	<input type="checkbox"/>	I A (A)	<	10.00	0	<input type="checkbox"/>	<input type="checkbox"/>	<input type="checkbox"/>	<input type="checkbox"/>	<input type="checkbox"/>	
#5	<input type="checkbox"/>	Frequency (Hz)	>	0.00	0	<input type="checkbox"/>	<input type="checkbox"/>	<input type="checkbox"/>	<input type="checkbox"/>	<input type="checkbox"/>	
#6	<input checked="" type="checkbox"/>	DI 212	=	25	0	<input type="checkbox"/>	<input type="checkbox"/>	<input type="checkbox"/>	<input type="checkbox"/>	<input type="checkbox"/>	
#7	<input type="checkbox"/>	Reverse Phase Sequence			0	<input type="checkbox"/>	<input type="checkbox"/>	<input type="checkbox"/>	<input type="checkbox"/>	<input type="checkbox"/>	
#8	<input type="checkbox"/>	Frequency (Hz)	>	0.00	0	<input type="checkbox"/>	<input type="checkbox"/>	<input type="checkbox"/>	<input type="checkbox"/>	<input type="checkbox"/>	
#9	<input type="checkbox"/>	Frequency (Hz)	>	0.00	0	<input type="checkbox"/>	<input type="checkbox"/>	<input type="checkbox"/>	<input type="checkbox"/>	<input type="checkbox"/>	
#10	<input type="checkbox"/>	Frequency (Hz)	>	0.00	0	<input type="checkbox"/>	<input type="checkbox"/>	<input type="checkbox"/>	<input type="checkbox"/>	<input type="checkbox"/>	
#11	<input type="checkbox"/>	Frequency (Hz)	>	0.00	0	<input type="checkbox"/>	<input type="checkbox"/>	<input type="checkbox"/>	<input type="checkbox"/>	<input type="checkbox"/>	
#12	<input checked="" type="checkbox"/>	Watt Demand (kW)	>	75.00	0	<input type="checkbox"/>	<input type="checkbox"/>	<input type="checkbox"/>	<input type="checkbox"/>	<input type="checkbox"/>	
#13	<input type="checkbox"/>	Frequency (Hz)	>	0.00	0	<input type="checkbox"/>	<input type="checkbox"/>	<input type="checkbox"/>	<input type="checkbox"/>	<input type="checkbox"/>	
#14	<input type="checkbox"/>	Frequency (Hz)	>	0.00	0	<input type="checkbox"/>	<input type="checkbox"/>	<input type="checkbox"/>	<input type="checkbox"/>	<input type="checkbox"/>	
#15	<input type="checkbox"/>	Frequency (Hz)	>	0.00	0	<input type="checkbox"/>	<input type="checkbox"/>	<input type="checkbox"/>	<input type="checkbox"/>	<input type="checkbox"/>	
#16	<input type="checkbox"/>	Frequency (Hz)	>	0.00	0	<input type="checkbox"/>	<input type="checkbox"/>	<input type="checkbox"/>	<input type="checkbox"/>	<input type="checkbox"/>	

Figure 5-31 Alarm relay trigger configuration from Acuvim software.

To read the status of the relay output from the Acuvim software, click on either the **I/O Modules *1** or **I/O Modules *2** page under the **Readings** tab depending on the logic number of the I/O module being used. The relay status will read **ON** when the relay switch is closed and will read **OFF** when the relay switch is open.

If the relay is in Control Mode, users can manually turn the relay ON/OFF from the Acuvim software by clicking on the **Control** button. Users will be prompted to enter the password of the meter (**0000** by default) in order to control the relay output.

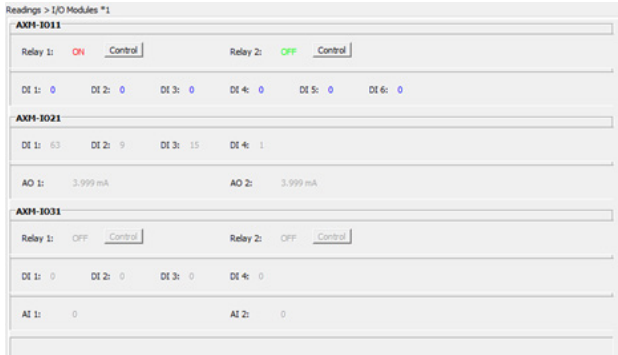

Figure 5-32 Relay Output Readings from Acuvim Software

5.1.9 Digital Output

The AXM-IO2 module supports the Digital Output and has two digital output channels that can be configured for either Alarm mode or Energy Pulse mode. The DO can be configured from the meter’s display (refer to Chapter 3), from the Acuvim software, or from the Modbus registers (refer to Chapter 6).

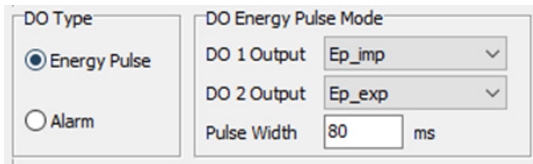

Figure 5-33 Digital Output Configuration from Acuvim Software

- **Energy Pulse:** In energy pulse mode, the DO will send pulses based on the energy accumulation that the meter is measuring. When selected, users can configure DO 1 and 2 Output to one of the following:
 - **Ep_imp:** Import Energy
 - **Ep_exp:** Export Energy
 - **Eq_imp:** Import Reactive Energy
 - **Eq_exp:** Export Reactive Energy
- **Pulse Width:** Users can configure the pulse width from 20-1000ms; the default is 80ms.
- **Alarm:** When configured in alarm mode, the module will send a pulse signal whenever an alarm is triggered.

Whenever the meter sends a pulse signal, a pulse icon can be seen on the meter's display. This icon will flash whenever a pulse signal is sent out from the digital output. Figure 5-33 shows where and how the pulse signal indicator is displayed.

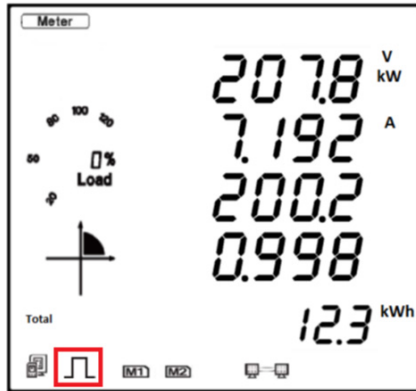

Figure 5-34 Pulse Signal Indicator on meter's display

Digital Output Pulse Constant Configuration

If the DO is configured for Energy Pulse Output mode, users will need to configure the pulse constant so that the meter will know how often to send a pulse signal out. In order to determine the correct pulse constant, users must know the rated current and rated voltage of their system. Below is an example on how to manually calculate the pulse constant.

Manual Pulse Constant Calculator:

The pulse constant must be configured in order for the meter to output the pulses accurately. The following shows how to calculate the pulse constant manually:

- Determine how many pulses represent 1kWh or how many kWh represents 1 pulse.

Example 1 pulse = 1 kWh

- Multiply the PT ratio and CT ratio i.e., PT1/PT2 * CT1/CT2

Example: PT ratio is 6600V/120V, and the CT ratio is 2000:5A.

$$\left(\frac{6600}{120}\right) \times \left(\frac{2000}{5}\right) = 22,000$$

NOTE: If no PTs were used, enter the default PT ratio of 400/400. If the CT2 output is 333mV, RCT, or 80/100/200mA use 1 as the CT2 value.

- Divide 1kWh by 22,000 i.e., (1/22000) kWh

- This means 1 pulse = (1/22000) kWh; therefore 22000 pulses = 1 kWh
- Since we get 22000 pulse/kWh, 22000 is the pulse constant.

Once the pulse constant value has been calculated, users can configure the pulse constant setting from the setting menu in the meter display (refer to Chapter 3), via Modbus registers (refer to Chapter 6), or Acuview software.

In the Acuview software, users can configure the pulse constant by clicking on the **General** page under the **Settings** tab. Users can configure the pulse constant for either real energy (Pulse/kWh) or reactive energy (Pulse/kvarh).

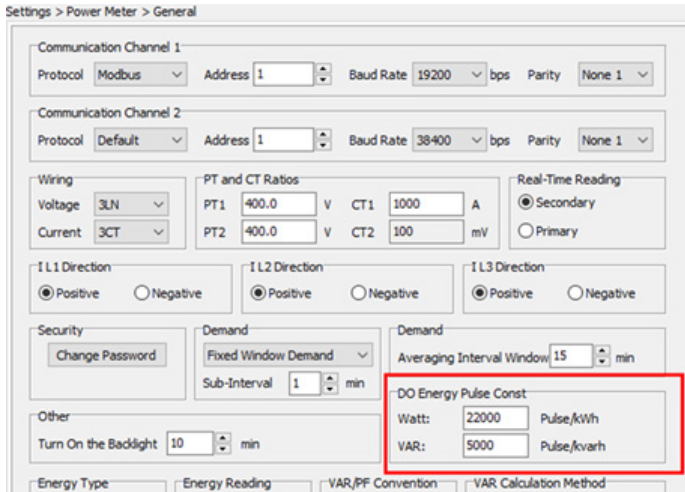

Figure 5-35 DO Energy Pulse Constant Configuration from Acuview software

Pulse Constant Configuration using Pulse Calculator:

If users are accessing the meter using the Acuview software, there is a pulse constant calculator tool that can be used to determine the correct pulse constant. Click on the **Tools** menu and select **Calculate Pulse Constant**.

- Under the **PT and CT Ratios** section of the page, enter the PT1 and PT2 which represent the rated input and output of the Potential Transformer (PT) that is being used with the meter. If PTs are not being used, leave these settings as the default of 400 for both PT1 and PT2.
- Enter the CT1 and CT2 values which represent the rated input and output of the Current Transformer (CT) being used with the meter.

NOTE: If this is a 333mV current input meter, consider CT2 as 1A. If this is a Rope CT meter, consider CT2 as 1A.

- Enter the value of the **Primary Maximum Power** by performing the following calculation: $3 \cdot (PT1 \cdot CT1) / 1000$
- Next enter in the desired pulse width and minimum interval for the energy pulse. The range for the pulse width is 20-1000ms.
- Once all values are entered, click on **Calculate Pulse Constant**
- The calculator will return the Maximum/Minimum values for the number of pulses as well as how much one pulse will represent with the configured PT/CT ratios and Primary Maximum Power.
- In the '**(Primary) 1 Pulse =**', enter in the amount of energy (kWh) needed to represent 1 pulse.
- Next, click on the **Update** button. The pulse constant will be displayed in the '**(Secondary) 1 kWh(kvarh) =**' section of the window.
- Once the pulse constant is determined, it will need to be configured in the general settings. In Figure 5-35, the pulse constant that is entered into the meter is 100.

Figure 5-36 Pulse Constant Calculator from Acuvue software

5.1.10 Analog Output

The analog output is supported in the AXM-IO2 module where users can convert measured electrical parameters into an analog voltage (0-5V/1-5V) or current (4-20mA/0-20mA).

Viewing the Digital status from the Meters Display:

- Press **H** and **V/A** at the same time. The screen will go blank, and **Meter** will begin flashing.
- Press the **P** or **E** button to move the flashing cursor over to **Digital I/O** and press **V/A** to enter.
- Next users will see the I/O selection screen. Select the appropriate I/O module and press **V/A**.
- With the cursor on **AO** press **V/A** to view the Analog Output readings.

NOTE: Refer to Chapter 3 section 3.7.4 on how to configure the AO from the meter's display.

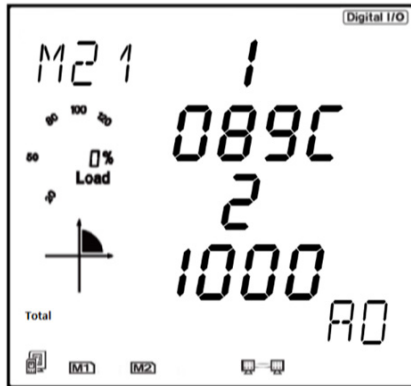

Figure 5-37 Analog Output readings from the meter's display

The values on the meter's display are in hex. The following equations will allow user to convert to the correct mA or voltage value. Using the equations below, the value of 089C for AO1 converts to 10.76mA or 2.69V and the value of 1000 for AO2 converts to 20mA or 5V.

$$Real Value = \frac{Displayed value}{4096} \times 20mA$$

$$Real Value = \frac{Displayed value}{4096} \times 5V$$

Figure 5-38 Analog Output conversion equations

How to view and configure the Analog Output from the Acuvue software:

The Analog Output settings can be configured from the Acuvue software on the **I/O Modules *1** or **I/O Modules *2** page under the **Settings** tab depending on the logic number of the I/O module being used. There are two AO channels that can be configured under the **Raw Channel** of **AO** section.

- **AO1/AO2:** Can be set to any of the parameters in Table 5-3
- **AO Type:** Can be set to 0-20mA/4-20mA (mA model) or 0-5V/1-5V (V model)

NOTE: The Setting value in Table 5-3 refers to the value configured when setting the analog output from the meter's display.

Table 5-3 Analog Output Parameters

Setting Value	Parameter
0	Frequency
1	Phase A Voltage
2	Phase B Voltage
3	Phase C Voltage
4	Average Line-Neutral Voltage
5	Line Voltage AB
6	Line Voltage BC
7	Line Voltage CA
8	Average Line-Line Voltage
9	Phase A Current
10	Phase B Current
11	Phase C Current
12	Average Current
13	Neutral Current
14	Phase A Power
15	Phase B Power
16	Phase C Power
17	Total System Power
18	Phase A Reactive Power
19	Phase B Reactive Power
20	Phase C Reactive Power
21	Total Reactive Power
22	Phase A Apparent Power
23	Phase B Apparent Power
24	Phase C Apparent Power
25	Total Apparent Power
26	Phase A Power Factor
27	Phase B Power Factor

Setting Value	Parameter
28	Phase C Power Factor
29	Total Power Factor



Figure 5-39 Analog Output settings

In the **AO Input/Output Transfer Curve** section, users can configure the scaling of the Analog Output signal relative to the parameter selected.

- **Single Slope:** When a single slope is selected, only the minimum (X1) and maximum (X4) values need to be specified to represent the AO signal. I.e., if the AO is a 4-20mA signal, the minimum value of the parameter will be 4mA (Y1) and the maximum will be 20mA (Y2).
- **Dual Slope:** When dual slope is selected, the minimum (X1), maximum (X4) and middle point (X2) need to be specified to represent the AO signal. I.e., if the AO is a 4-20mA signal, the minimum value of the parameter will be 4mA (Y1), the middle point of the parameter will be 12mA (Y2) and the maximum will be 20mA (Y2).
- **Triple Slope:** When the triple slope is selected, four points need to be specified for both the input parameter and Analog Output. The four points should be configured in increasing order.

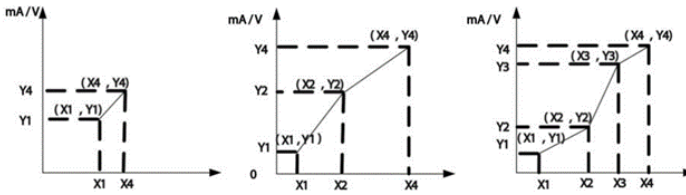

Figure 5-40 Relationship between analog output and electrical parameters

Certain parameters have a range that can be configured for the AO.

- Frequency: 45Hz-65Hz
- Phase Voltage: V1, V2, V3, and Vavg: 0-480V
- Line Voltage: V12, V23, V31, and Vavg: 0-831V
- Current: I1, I2, I3, and Iavg depend on the current input of the meter
 - 5A: $0-(CT1*10)/CT2$ A
 - 1A: $0-(CT1*10)/CT2$ A
 - $333mV/RCT/mA: 0-(CT1/(CT2/10))$ A
- Power Factor: -1.0 to 1.0
- Power: $-(3*480*I)$ to $(3*480*I)$, where "I" is the CT1 value
 - Phase Power: $480*I$, where "I" is the CT1 value

NOTE: The maximum value of the AO will be 1.2 times the range. For example, 6V for analog voltage and 24mA for analog current.

NOTE: When the wiring mode of the meter is in either 2LL or 3LL, the phase measurements for the voltage, active, reactive, apparent power, and power factor will be 0.

Reading the Analog Output form the Acuvue software:

To read the value of the Analog Output from the Acuvue software, click on either the **I/O Modules *1** or **I/O Modules *2** page under the **Readings** tab depending on the logic number of the I/O module being used.

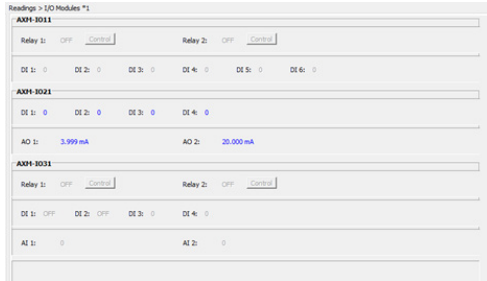

Figure 5-41 Analog Output readings on the Acuview software

5.1.11 Analog Input

The analog input is supported in the AXM-IO3 module where users can read either 0-20mA/4-20mA or 0-5V/1-5V. Analog input can measure into an analog voltage (0-5V) or current (4-20mA).

Viewing the Analog Input reading from the Meters Display:

- Press **H** and **V/A** at the same time. The screen will go blank, and **Meter** will begin flashing.
- Press the **P** or **E** button to move the flashing cursor over to **Digital I/O** and press **V/A** to enter.
- Next users will see the I/O selection screen. Select the appropriate I/O module and press **V/A**.
- With the cursor on **AI** press **V/A** to view the Analog Input readings.

NOTE: Refer to Chapter 3 section 3.7.4 on how to configure the AI from the meters display.

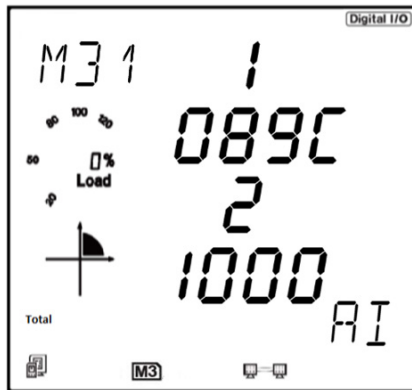

Figure 5-42 Analog Input reading from the meter display

The analog input value can be viewed on the meter's display as a hex number. The AI value ranges from 0-4095.

The figure below shows the relationship between the AI value and the input analog value. Similar to the analog output, the analog input can be converted.

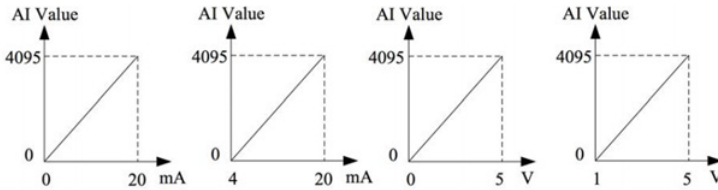

Figure 5-43 relationship between AI value and input analog value

$$Real\ Value = \frac{Displayed\ value}{4096} \times 5V$$

$$Real\ Value = \frac{Displayed\ value}{4096} \times 20mA$$

Figure 5-44 Analog Input conversion equation

Viewing the Analog Input Reading from the Acuvuev software:

The Analog Input settings can be configured from the Acuvuev software on the **I/O Modules *1** or **I/O Modules *2** page under the **Settings** tab depending on the logic number of the I/O module being used. Users can configure the input signal type. If they have a mA version, the input can be configured as 0-20mA/4-20mA, or if the voltage type is used, the input can be configured as 0-5V/1-5V.

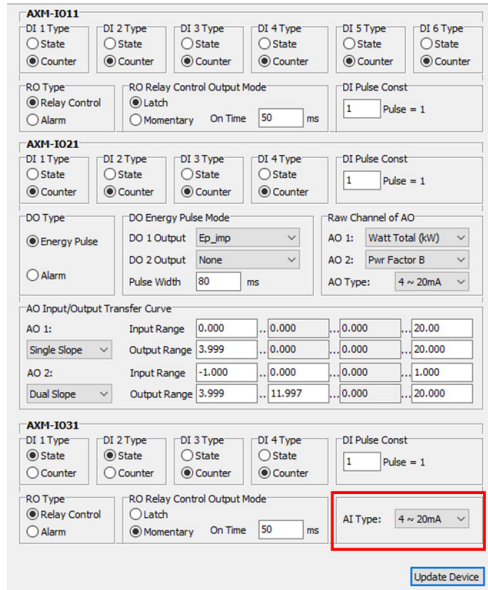

Figure 5-45 Analog Input Type Setting

Reading the analog input value from the Acuvim software:

Similar to the display, the analog input value is read as a hex number and needs to be converted to the correct mA or V signal. In the figure below, AI1 reads 9 which converts to 0.01V or 0.044mA and AI2 reads 3420 which converts to 4.17V or 16.7mA.

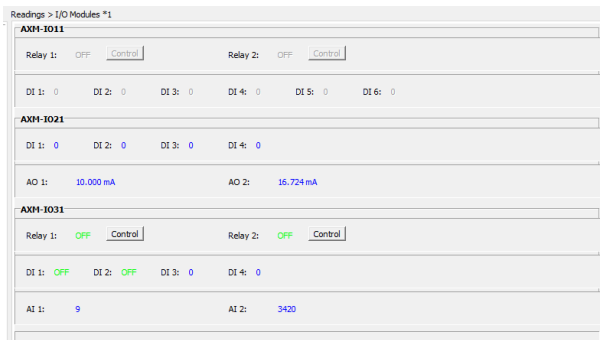

Figure 5-46 Analog Input Readings on the Acuvim software

5.2 Profibus Module AXM-PROFI

5.2.1 Introduction of PROFIBUS Technology

Profibus (Process Field Bus) is an international field bus standard that is widely used in the automation technology of manufactures and the flow industry. It is a widely used, open digital communication system which is suitable for high speed, time-critical and high-reliability communications.

PROFIBUS is one kind of open style field bus standard which is promoted by SIEMENS Corporation. In 1989, it became the German standard DIN19245, in 1996, it became the European standard EN50170, in 1999 it was accepted as part of the international standard IEC 61158 and in 2001 it became the Chinese national standard JB/T 10308.3-2001 for field bus of machinery industry controlling systems.

There are 3 types of PROFIBUS: PROFIBUS-DP(Decentralized Periphery), PROFIBUS-PA(Process Automation) and PROFIBUS(Field bus Specification Message). All types follow the same protocol.

With optimized, high-speed, low-cost communication links, PROFIBUS-DP is especially used in automatic controlling systems and equipment level decentralized I/O communication. It can meet real-time response, stability and reliability of equipment level and distributed control systems.

The PROFIBUS module uses the PROFIBUS-DP(V0) protocol.

5.2.2 PROFIBUS module application notes

The PROFIBUS technical data and specifications should be read for the AXM-PROFI before using it. In addition, familiarity with the Modbus parameter addresses would be an asset.

The AXM-PROFI can only be used as a slave in the PROFIBUS network. The slave address can range from 0-126 and can only be set through the entrance. If the address is changed, it will take effect immediately.

The AXM-PROFI can operate with baud rates between 9.6kbps to 12Mbps.

The AXM-PROFI terminals should be connected properly to avoid problems during installation.

Please read the GSD file of the PROFIBUS module carefully before using it. The GSD file contains the technical information such as device name, ID number, and other important details.

Please contact Technical Support (support@accuenergy.com) to obtain the GSD file.

5.2.3 Appearance and Dimensions

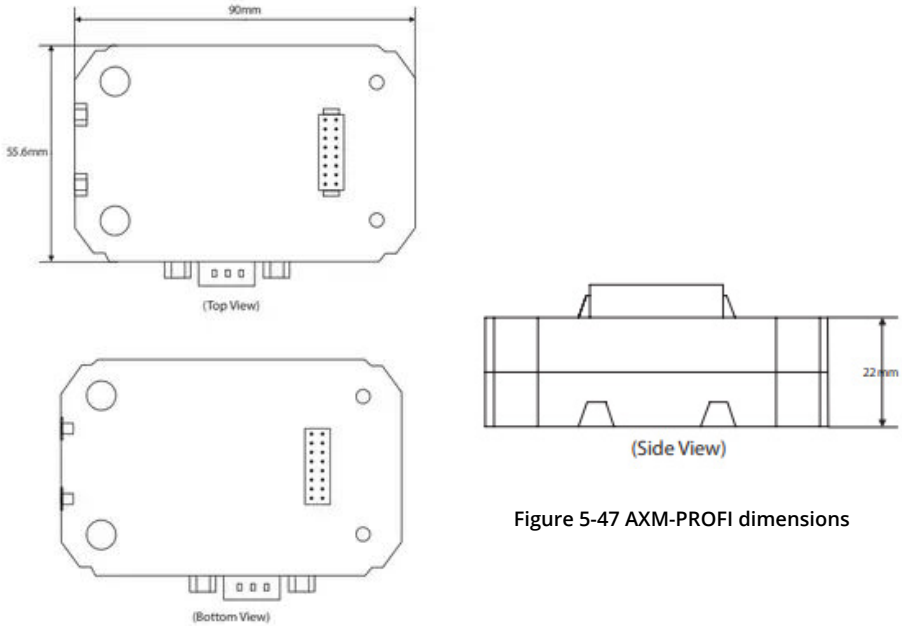

Figure 5-47 AXM-PROFI dimensions

5.2.4 Installation Method

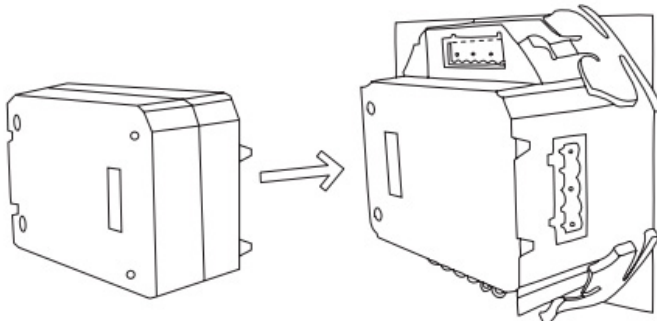

Figure 5-48 AXM-PROFI Installation to Acuvim II meter

The AXM-PROFI module is linked to the Acuvim II series meter by a communication plug. Other extended modules, such as the I/O modules, can be linked to the Acuvim II series meter through the AXM-PROFI.

1. Insert the installation clips to the counterpart of the Acuvim II meter and then press the AXM-PROFI module lightly to establish the linking.
2. Tighten the installation screws.

NOTE: Do not install any modules when power is applied to the meter.

5.2.5 Definition of DP Interface

The AXM-PROFI module uses a standard 9-pin, D-type connector to access the PROFIBUS network. The mechanical and electrical characteristics of the connector are consistent with the requirements of IEC 807-3. The PROFIBUS connector is a socket, and the counterpart connector of cable is a plug.

The connector pins are as followed:

Table 5-4 AXM-PROFI Connector Table

Pins	RS-485	ID	Content	Used by PROFIBUS
1	--	Shield	Power GND	NO
2	--	N24V	-24V output	NO
3	B	RXD/TXD-P	Data P (Receive/Send)	YES
4	--	CNTR-P	Controlling P	YES
5	C	DGND	Digital Ground	YES
6	--	Vp	Positive Voltage	YES
7	--	P24V	+24V output	NO
8	A	RXD/TXD-N	Data N (Receive/Send)	YES
9	--	CNTR-N	Controlling N	NO

NOTE: Pin 4 is used for RTS controlling and TTL, which is optional.

5.2.6 Cable

A shielded twisted pair cable is recommended as reference to the EIA RS-485 standard. If the interference is within the EIA RS-485 standard, then a non-shielded twisted pair cable may be used.

5.2.7 Bus Terminal

Based on the DP standard, the first station and the last station in the PROFIBUS-DP network should connect the bus terminal (resistor) and it is not necessary for other stations, as shown in the figure below.

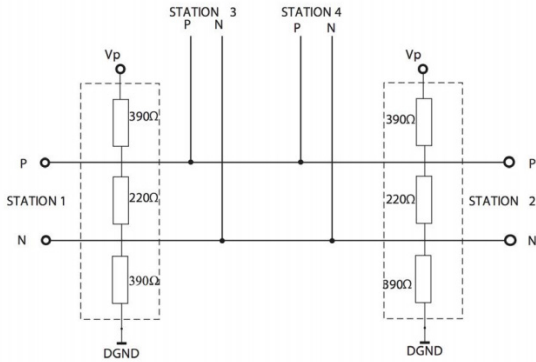

Figure 5-49 DP station Connection Diagram

The bus terminal is composed of three resistors and a connection wire, where Vp is the supply positive voltage and DGND is the Digital Ground. When the bus is idle, the bus terminal makes the data P level higher than data N so the bus's idle signal is always 1.

5.2.8 Address Setting

The AXM-PROFI module can only be used as a slave in the PROFIBUS network. Its slave address ranges from 0-126, which can only be configured from the meter display. If the address is changed, it will take effect immediately.

The figure below shows the configuration setting for the AXM-PROFI:



Figure 5-50 AXM-PROFI address setting on meter display

5.2.9 Baud Rate

The AXM-PROFI supports baud rates from 9.6kbps to 12Mbps in the PROFIBUS network.

5.2.10 GSD Files

A PROFIBUS-DP Master can exchange data with various slave devices. In order to identify a slave device, it is not necessary to obtain the technical data of the device itself. The file where the data is described is called the Device Description Data File (GSD).

Because of the importance of the GSD file, please read it carefully before using the AXM-PROFI module. The GSD file is provided in pure text format with detailed comments.

- As a DP slave device, the AXM-PROFI module supports the protocol of V0 revision.
- The AXM-PROFI module data interface is optional. It supports module 1 and module 2. Module 1 is a 16-bit word input/output interface. Module 2 is a 32-bit input with 1 output interface.

5.2.11 Information Exchange

A variety of information from the Acuvim II meter can be transmitted by the AXM-PROFI module, such as electrical measurements and other parameters. The basic communication method of the Acuvim II series meter is RS-485, which uses the Modbus-RTU protocol. In order to use the same addresses as Modbus, the communication format of PROFIBUS-DP is 16-bit word input/output.

It is recommended to refer to the communication part of the Acuvim II manual (Chapter 6) for the list of Modbus addresses, function codes, the relationship between values, and other details.

Some examples are:

1. There are various function codes, such as 01H, 02H, 04H, 05H, and 10H for the various categorized parameters. Different function codes have different formats for the query and response frames.
2. There are specific relationships between numerical values in the registers and the real physical value.
3. Different parameters may have different data length and data type.

These three points are also suitable for the PROFIBUS-DP protocol in the AXM-PROFI modules.

Function codes, such as 01H, 02H, and 03H, are inquiry commands. For users to quickly switch the inquiry contents, 8 channels are defined, from 1 to 8, in order to update the data more quickly.

5.2.12 Format of Function code 01H

Function code 01H is used to the read relay status. The format of this function code is defined as follows:

Query:

Table 5-5 Function Code 01H Query Format

	Frame Bytes	Caption
1	Byte 1	Channels 1 to 8
2	Byte 2	01H
3	Byte 3	Starting Address high byte
4	Byte 4	Starting Address low byte
5	Byte 5	Quantity of coils high byte
6	Byte 6	Quantity of coils low byte
7	Byte 7-32	0

Here, 16-bit words are usually required for I/O data in GSD file so that all other bytes after Byte 7 are set to 0.

Response:

Below is the response of the slave device sending its information to the master device.

Table 5-6 Function 10 Response Format

	Frame Bytes	Caption
1	Byte 1	The channel of inquiry frame
2	Byte 2	01H
3	Byte 3	byte count
4	Byte 4	coil status
5	Byte 5~32	0

The coils in the response message are packed as one coil per bit of the data field. Status is indicated as 1=ON and 0=OFF. The LSB of the first data byte contains the output addressed in the query. The other coils follow toward the high order end of this byte, and from low order to high order in subsequent bytes.

Example: reading Relay1 and Relay2 status (start register address is 0000H). Use 4 channels.

Query:

Byte1	Byte2	Byte3	Byte4	Byte5	Byte6	Byte7-32
04H	01H	00H	00H	00H	02H	00H

Response:

Byte1	Byte2	Byte3	Byte4	Byte5	Byte6	Byte7-32
04H	01H	01H	02H	00H	00H	00H

Coil Status:

7	6	5	4	3	2	1	0
0	0	0	0	0	0	1	0

MSB

LSB

(Relay 1 = OFF, Relay 2=ON)

5.2.13 Format of function code 05H

The message with function code (05H) in MODBUS-RTU forces a single relay to either the on or off position. The data value FFOOH will set the relay on and the value 0000H will turn it off. All other values are invalid and will not affect the relay. In PROFIBUS-DP, the format of function code 05H is defined as follows:

Query:

Table 5-7 Function Code 05H Query Format

	Frame Bytes	Caption
1	Byte 1	FAH
2	Byte 2	05H
3	Byte 3	outputs address high byte
4	Byte 4	outputs address low byte
5	Byte 5	outputs value high byte
6	Byte 6	outputs value low byte
7	Byte 7-32	0

NOTE: Because PROFIBUS-DP V0 exchanges information periodically, controlling information such as function code 05H should be used carefully.

Response:

The normal response to the command request is to re-transmit the message as received after the relay status has been altered.

Table 5-8 Function Code 05H Response Format

	Frame Bytes	Caption
1	Byte 1	FAH
2	Byte 2	05H
3	Byte 3	outputs address high byte
4	Byte 4	outputs address low byte
5	Byte 5	outputs value high byte
6	Byte 6	outputs value low byte
7	Byte 7~32	0

Example: setting Relay2 on.

Query:

Byte1	Byte2	Byte3	Byte4	Byte5	Byte6	Byte7~32
FAH	05H	00H	01H	FFH	00H	00H

Response:

Byte1	Byte2	Byte3	Byte4	Byte5	Byte6	Byte7~32
FAH	05H	00H	01H	FFH	00H	00H

5.2.14 Format of function code 02H

Function code 02H is used to read DI status in MODBUS-RTU. In PROFIBUS-DP, the format of function code 02H is defined as follows:

Query:

Table 5-9 Function Code 02H Query Format

	Frame Bytes	Caption
1	Byte 1	Channels can be chosen from 1 to 8
2	Byte 2	02H
3	Byte 3	starting address high byte
4	Byte 4	starting address low byte
5	Byte 5	quantity of digital inputs high byte
6	Byte 6	quantity of digital inputs low byte
7	Byte 7~32	0

Response:

Table 5-10 Function Code 02H Response Format

	Frame Bytes	Caption
1	Byte 1	The channel of inquiry frame
2	Byte 2	02H
3	Byte 3	byte count

	Frame Bytes	Caption
4	Byte 4	inputs status1
5	Byte 5	inputs status2 (or 0)
6	Byte 6	inputs status3 (or 0)
7	Byte 7	inputs status4 (or 0)
8	Byte 8-32	0

The digital inputs in the response message are packed as one input per bit of the data field. Status is indicated as 1=ON; 0=OFF. The LSB of the first data byte contains the input addressed in the query. The other inputs follow towards the high order end of this byte, and from low order to high order in subsequent bytes.

Example: reading 4 DI statuses (starting address is 0000H). Use 6 channels.

Query:

Byte1	Byte2	Byte3	Byte4	Byte5	Byte6	Byte7-32
06H	02H	00H	00H	00H	04H	00H

Response:

Byte1	Byte2	Byte3	Byte4	Byte5-32
06H	02H	01H	06H	00H

DI Status:

7	6	5	4	3	2	1	0
0	0	0	0	0	1	1	0

MSB

LSB

(DI1 = OFF, DI2=ON, DI3 = ON, DI4 = OFF)

5.2.15 Format of function code 03H

This function code is used in MODBUS-RTU to read the contents of a contiguous block of holding registers in Acuvim II meter. In PROFIBUS-DP, the format of function code 03H is defined as follows:

Query:

Table 5-11 Function Code 03H Query Format

	Frame Bytes	Caption
1	Byte 1	Channels can be chosen from 1 to 8
2	Byte 2	03H
3	Byte 3	starting address high byte

	Frame Bytes	Caption
4	Byte 4	starting address low byte
5	Byte 5	quantity of registers high byte
6	Byte 6	quantity of registers low byte
7	Byte 7~32	0

“Quantity of registers” identifies how many words will be read.

Response:

Table 5-12 Function Code 03H Response Format

	Frame Bytes	Caption
1	Byte 1	The channel of inquiry frame
2	Byte 2	03H
3	Byte 3	byte count
4	Byte 4	Register value1 high byte
5	Byte 5	Register value1 low byte
6	Byte 6
7	Byte 7~32

“Byte count” identifies how many bytes will be read.

The register data in the response message is packed as two bytes per register, with the binary contents correctly justified with each byte. For each register, the first byte contains the high order bits and the second contains the low order bits.

NOTE: The response has a 16-word frame, so the maximum “quantity of registers” should less than 15. Otherwise, it will return an error result.

Example: Reading 3 measured data (F, V1, V2) from Acuvim II meter.

The data address of F includes 4000H and 4001H. The data address of V1 includes 4002H and 4003H. The data address of V2 includes 4004H and 4005H. (Uses 7 channels)

Query:

Byte1	Byte2	Byte3	Byte4	Byte5	Byte6	Byte7~32
07H	03H	40H	00H	00H	06H	00H

Response:

Byte1	Byte2	Byte3	Byte4	Byte5	Byte6	Byte7	Byte8
07H	03H	0CH	42H	48H	00H	00H	42H
Byte9	Byte10	Byte11	Byte12	Byte13	Byte14	Byte15	Byte16~32
C7H	CCH	CDH	42H	C8H	33H	33H	00H

(F=42480000H(50.00Hz), V1=42C7CCCDH(99.9v), V2=42C83333H(100.1v)).

NOTE: The relationship between the numerical value in the register of the meter and the actual physical value is described in Chapter 6.

5.2.16 Format of function code 10H

This function code is used in MODBUS-RTU to write a block of continuous registers in the Acuvim II meter, such as system parameters setting and so on. In PROFIBUS-DP, the format of function code 10H is defined as follows:

Query:

Table 5-13 Function Code 10H Query Format

	Frame Bytes	Caption
1	Byte 1	FAH
2	Byte 2	10H
3	Byte 3	starting address high byte
4	Byte 4	starting address low byte
5	Byte 5	quantity of registers high byte
6	Byte 6	quantity of registers low byte
7	Byte 7	byte count
8	Byte 8	register value 1 high byte
9	Byte 9	register value 1 low byte
10	Byte 10	register value 2 high byte
11	Byte 11	register value 2 high byte
12
13	Byte 32	0

“Quantity of registers” indicates how many words will be written.

“Byte count” indicates how many bytes will be written. If the “quantity of register” is N, then “byte count” is (N×2).

NOTE: The response has a 16-word frame, so the maximum “quantity of registers” should be less than 13. Otherwise, it will return an error result.

Response:

The normal Response returns the function code, starting address, and quantity of registers written.

Table 5-14 Function Code 10H Response Format

	Frame Bytes	Caption
1	Byte 1	FAH
2	Byte 2	10H
3	Byte 3	starting address high byte
4	Byte 4	starting address low byte
5	Byte 5	quantity of registers high byte
6	Byte 6	quantity of registers low byte
7	Byte 7~32	0

Example: Preset the import active energy (EP_imp) to 17807783.3 KWh. Based on the relationship between the register value and the physical value, we can get the register value in hex as 0A9D4089H. The data address of EP_imp includes 4048H and 4049H.

Query:

Byte1	Byte2	Byte3	Byte4	Byte5	Byte6	Byte7	Byte8	Byte9	Byte10	Byte11	Byte12~32
FAH	10H	40H	48H	00H	02H	04H	0AH	9DH	40H	89H	00H

Response:

Byte1	Byte2	Byte3	Byte4	Byte5	Byte6	Byte7~32
FAH	10H	40H	48H	00H	02H	00H

Example Projects

To facilitate your understanding of the PROFIBUS module, we have developed a PLC-based DEMO engineering application program. Please read the DEMO procedure documentation for specific information. This DEMO is available upon request; please call Technical Support.

5.2.17 32 Word Output Interface

The 32-word output interface is a fixed parameter.

Transmission format is as follows:

- Ua_rms(2 bytes), Ub_rms(2 bytes), Uc_rms(2 bytes), Uavg_rms(2 bytes);
- Uab_rms(2 bytes), Ubc_rms(2 bytes), Uca_rms(2 bytes), Ulag_rms(2 bytes);
- la_rms(2 bytes), lb_rms(2 bytes), lc_rms(2 bytes), lavg_rms(2 bytes);
- Pa_rms(2 bytes), Pb_rms(2 bytes), Pc_rms(2 bytes), Pavg_rms(2 bytes);

Epa_imp(4 bytes), Epa_exp(4 bytes);
Epb_imp(4 bytes), Epb_exp(4 bytes);
Epc_imp(4 bytes), Epc_exp(4 bytes);
Ep_imp(4 bytes), Ep_exp(4 bytes);

5.3 RS485 Module (AXM-485)

5.3.1 Communication Parameters Setting

RS485, also known as EIA-485, is a telecommunications standard for binary serial communications between devices. RS485 is the most versatile communication standard in the standard series defined by the EIA, and it is a widely used communication interface in Data Acquisition and Control applications where multiple nodes communicate with each other.

The RS485 signals are floating, and each signal is transmitted over a differential signal + line and a differential signal - line. The RS485 receiver compares the voltage difference between both lines, instead of the absolute voltage level on a signal line. To obtain better communication performance, the differential signal + and differential signal - lines are twisted. The twisted-pair adds immunity against noise. If high noise immunity is needed, the combination of twisting and shielding is often used. For example, shielded twisted pair or foiled twisted pair networking cables can be used in high noise environments.

5.3.2 Function Description of RS485 module

AXM-RS485 module uses RS485 serial communication and the Modbus-RTU protocol, just like the on-board RS485 port of the Acuvim II series meter. It provides a second RS485 port for serial communication and it can work with the on-board RS485 serial communication simultaneously. The terminals of communication are generally A, B, and S where A is for the differential signal +, B is for the differential signal -, and S is connected to the shield of the twisted pair cables.

- Up to 32 devices can be connected on an RS485 bus without repeaters.
- Use good quality shielded twisted pair cable, AWG22 (0.5mm²) or higher.
- The overall length of the RS485 cable connecting all devices should not exceed 1200m (4000ft).
- Every A(+) should be connected to A(+), B(-) to B(-), otherwise, it will influence the network or damage the communication interface.
- When using a long communication cable to connect several devices, and anti-signal reflecting resistor (typical value 120Ω-300Ω/0.25W) is normally added to the end of the cable beside the last meter to prevent communication quality degradation.

5.3.3 Appearance and Dimensions

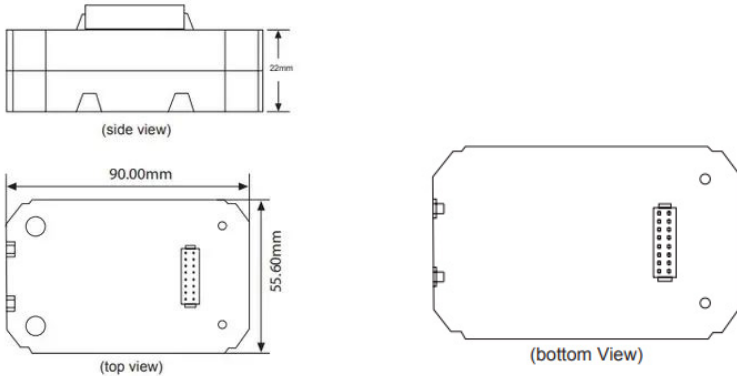

Figure 5-51 AXM-RS485 Dimensions

5.3.4 Installation Method

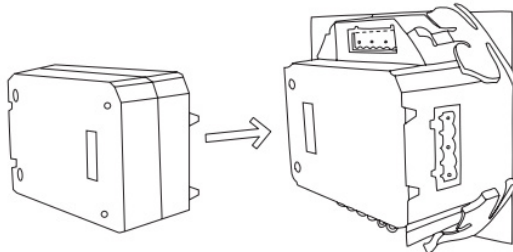

Figure 5-52 AXM-RS485 installation to Acuvim II meter

The RS485 module is linked to the meter by a communication plug. It also can be linked to other extended modules.

1. Insert the installation clips to the counterpart of the meter, and then press the RS485 module lightly, so linking is established.
2. Tighten the installation screws.

NOTE: Install AXM-RS485 Module carefully to avoid damage. Under no circumstances should any installation be done with the meter powered on. Failure to do so may result in injury or death.

5.3.5 Connection Method

The RS485 module uses 2-wire, half-duplex communication mode, which is the same as what the on-board RS485 port is using. If the master does not have an RS485 communication port, a converter (such as an RS232/RS485 or a USB/RS485 converter) will be required. Typical RS485 Network topologies include line, circle, and star. The shield of each segment of the RS485 cable must be connected to the ground at one end only.

The default baud rate of the RS485 module is 38400 bps. Users can change the baud rate in system settings S03 of the Acuvim II series meter.

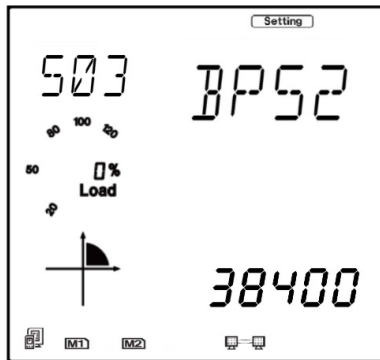

Figure 5-53 Baud Rate setting for the AXM-RS485 module

The data format is start bit + 8n data bit + parity + stop bit. NON1, NON2, odd, and even can be selected for parity mode on S31 of Setting page of Acuvim II meter.

- **NON1:** represents non-parity, single stop bit
- **NON2:** represents non-parity, double stop bit
- **Odd:** represents odd-parity, single stop-bit
- **Even:** represents even parity, single stop bit.

The default setting for the parity is NON1.

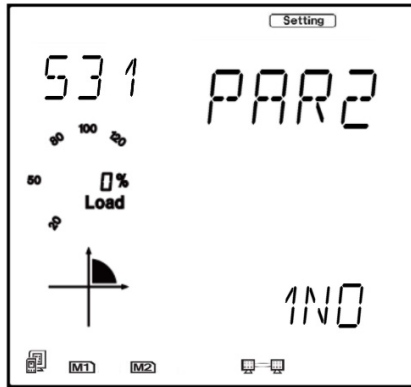

Figure 5-54 Parity setting for the AXM-RS485 module

NOTE: If AXM-WEB/AXM-WEB2 is used, the RS-485 module's parity (PAR2) must be set as None1 so that the meter will recognize the communications module.

5.3.6 Communication Address

The communication address used for the AXM-RS485 module is located on page S36.



Figure 5-55 Address setting for AXM-RS485

Chapter 6: Communication Part I

This chapter will mainly discuss how to communicate using the Modbus protocol. It is highly recommended that previous chapters be read before moving onto Chapter 6, a familiarity with Modbus would also be helpful.

6.1 Modbus Protocol Introduction

Modbus RTU is the communication protocol used in Acuvim II series meters. Data format and error check methods are defined in the Modbus protocol. The half duplex query and respond mode is adopted in the Modbus protocol. There is only one master device in the communication network. The others are slave devices, waiting for the query of the master.

Transmission Mode

The mode of transmission defines the data structure within a frame and the rules used to transmit data. The mode is defined in the following which is compatible with Modbus RTU mode.

Framing

Table 6-1 Data Framing

Address	Function	Data	Check
8-Bits	8-Bits	Nx8-Bits	16-Bits
Coding System		8-Bit Binary	
Start Bit		1	
Data Bits		8	
Parity		No parity, odd parity, even parity	
Stop Bit		1 or 2	
Error Checking		CC check	

Address Field

The address field of a message frame contains eight bits. Valid slave device addresses are in the range of 0~247 decimal. A master addresses a slave by placing the slave address in the address field of the message. When the slave sends its response, it places its own address in this address field of the response to let the master know which slave is responding.

Function Field

The function code field of a message frame contains eight bits. Valid codes are in the range of 1~255 decimal. When a message is sent from a master to a slave device the function code field tells the slave what kind of action to perform.

Table 6-2 Function Code Transmission

Code	Meaning	Action
01	Read Relay Output Status	Obtain current status of Relay Output
02	Read Digital Input (DI) Status	Obtain current status of Digital Input
03	Read Data	Obtain current binary value from one or more registers
05	Control Relay Output	Force relay state to "ON" or "OFF"
16	Press Multiple-Register	Place specific binary values into a series of consecutive Multiple-Registers

Data Field

The data field is constructed using sets of two hexadecimal digits, in the range of 00 to FF hexadecimal. The data field of messages sent from a master to slave devices contains additional information which the slave must use to take the action defined by the function code. This can include items such as register addresses, the quantity of items to be handled, and the count of actual data bytes in the field. For example, if the master writes to a group of registers in the slave (function code 10 hexadecimal), the data field specifies the starting register, how many registers to write, the count of data bytes to follow 234 in the data field, and the data to be written into the registers.

If no error occurs, the data field of a response from a slave to a master contains the data requested. If an error occurs, the field contains an exception code that the master application can use to determine the next action to be taken. The data field can be non-existent if there is zero length in certain kinds of messages.

Error Check Field

Every message includes an error checking field which is based on the Cyclical Redundancy Check (CRC) method. The CRC field checks the contents of the entire message. It is applied regardless of any parity check method used for the individual characters of the message. The CRC field is two bytes long, containing a 16-bit binary value. The CRC value is calculated by the transmitting device, and is appended to the message. The receiving device recalculates the CRC value during reception of the message, and compares the calculated value to the actual value it received in the CRC field. If the two values are not equal, an error will be reported. CRC calculation is first started by

preloading the whole 16-bit register to 1's. The process begins by applying successive 8-bit bytes of the message to the current contents of the register. Only the eight bits of data in each character are used for generating the CRC. Start and stop bits and the parity bit do not apply to the CRC. When generating the CRC, each 8-bit character is exclusive "ORed" with the register contents. The result is shifted towards the least significant bit (LSB), with a zero filled into the most significant bit (MSB) position. The LSB is extracted and examined, if the LSB equals to 1, the register is exclusive "ORed" with a preset, fixed value; if the LSB equals to 0, no action will be taken. This process is repeated until eight shifts have been performed. After the last (eighth) shift, the next 8-bit byte is exclusive ORed with the register's current value, and the process repeats for eight more shifts as described above. After all the bytes of the message have been applied, the final contents of the register, which should exchange the high-byte and the low-byte, is the CRC value. When the CRC is appended to the message, the low-order byte is appended first, followed by the high-order byte.

6.2 Communication Format

Table 6-3 Explanation of Frame

Address	Function	Data start register HI	Data start register LO	Number of data start registers HI	Number of data start registers LO	CRC 16 HI	CRC 16 LO
06H	03H	00H	00H	00H	21H	84H	65H

1. Reading Relay Status

Function Code 01

This function code is used to read the status of the relay in the meter.

1=On, 0=Off, Relay1's address is 0000H,

Relay2's address is 0001H and so on.

The following query is to read the relay status for the meter with communication address 17.

Query:

Table 6-4 Read the Status of Relay1 and Relay2 Query Message

Address	Function	Data start register HI	Data start register LO	Number of data start registers HI	Number of data start registers LO	CRC 16 HI	CRC 16 LO
11H	01H	00H	00H	00H	02H	BFH	SBH

Response:

The Acuvim II series meter response includes the meter address, function code, quantity of data

byte, the data, and error checking. An example response to read the status of Relay1 and Relay2 is shown as Table 6-5. The status of Relay1 and Relay2 are responding to the last 2 bits of the data.

Relay1: bit0, Relay2: bit1

Table 6-5 Relay Status Response

Address	Function	Byte Count	Data	CRC 16 HI	CRC 16 LO
11H	01H	01H	02H	D4H	89H

The content of the data is:

7	6	5	4	3	2	1	0
0	0	0	0	0	0	1	0

MSB **LSB**

Relay1 = OFF (LSB), Relay2 = ON (Left to LSB)

2. Read Status of DI

Function Code 02 1=ON, 0=OFF

DI's address is 0000H, DI2's address is 0001H, and so on.

The following query is to read the status of 4 DI's of Acuvim II series meter with communication address 17.

Query:

Table 6-6 Read the Status of Relay1 and Relay2 Query Message

Address	Function	Data start register HI	Data start register LO	Number of data start registers HI	Number of data start registers LO	CRC 16 HI	CRC 16 LO
11H	02H	00H	00H	00H	04H	7BH	59H

Response:

The Acuvim II series meter response includes the meter address, function code, quantity of data characters, the actual data characters and error checking. An example response to read the status of 4 DI's are shown in Table 6-7. The DI status corresponds to the last 4 bits of the data.

DI1: bit0; DI2: bit1; DI3: bit2; DI4: bit3

Table 6-7 Relay Status Response

DI1: bit0		DI2: bit1		DI3: bit2		DI4: bit3
Transaction Identifier HI	Transaction Identifier LO	Protocol Identifier HI	Protocol Identifier LO	Length HI	Length LO	Unit Identifier
11H	02H	00H	00H	00H	04H	7BH

Function	Byte Count	Data
02H	01H	0FH

The content of the data is:

7	6	5	4	3	2	1	0
0	0	0	0	1	1	1	1

MSB LSB

3. Read Data (Function Code 03)

Query:

This function allows the master to obtain the measurement results from the Acuvim II series meter. Table 6-8 is an example of reading the measured data (F, V1 and V2) from slave device number 17, the data address of F is 4000H, 4001H; V1’s address is 4002H, 4003 and V2’s address is 4004H, 4005H.

Table 6-8 Read F, V1, V2 Query Message

Address	Function	Data start register HI	Data start register LO	Number of data start registers HI	Number of data start registers LO	CRC 16 HI	CRC 16 LO
11H	03H	40H	00H	00H	06H	D2H	98H

Response:

The Acuvim II series meter response includes the meter address, function code, quantity of data bytes, data and error checking. An example response to read F, V1 and V2 (F=42480000H (50.00Hz), V1=42C7CCCDH (99.9V), V2=42C83333H (100.1V)) is shown:

Table 6-9 Read F, V1 and V2 Message

Address	Function	Byte Count	Data1 HI	Data1 LO	Data2 HI	Data2 LO	Data3 HI	Data3 LO	Data4 HI	Data4 LO
11H	3H	0CH	42H	48H	00H	00H	42H	C7H	CCH	CDH

Data5 HI	Data5 LO	Data6 HI	Data6 LO	Data16 HI	Data16 LO
42H	C8H	33H	33H	CAH	7FH

4. Control Relay (Function Code 05)

Query:

This message forces a relay to either turn “ON” or “OFF”. Any relay that exists within Acuvim II

Series meter can be forced to either “ON” or “OFF” status. The data value FF00H will set the relay on and the value 0000H will turn it off; all other values are invalid and will not affect that relay.

The example below is a request to the Acuvim II Series meter with the address of 17 to turn on Relay1.

Table 6-10 Control Relay Query Message

Address	Function	DO Address HI	DO Address LO	Value HI	Value LO	CRC 16 HI	CRC 16 LO
11H	05H	00H	00H	FFH	00H	8EH	AAH

Response:

The normal response to the command request is to re-transmit the message as received after the relay status has been altered.

Table 6-11 Control Relay Response Message

Address	Function	Relay Address HI	Relay Address LO	Value HI	Value LO	CRC 16 HI	CRC 16 LO
11H	05H	00H	00H	FFH	00H	8EH	AAH

5. Preset/Reset Multi-Register (Function Code 16)

Query:

Function 16 allows the user to modify the contents of a multi-register. Some registers of Acuvim II series meter can have their contents changed by this message. The example below is a request to an Acuvim II series meter with the address of 17 to preset Ep_imp as “17807783.3kWh”, while its HEX value is 0A9D4089H. Ep_imp data address is 4048H and 4049H.

Table 6-12 Preset Multi-Registers Query Message

Address	Function	Data start register HI	Data start register LO	Number of data start registers HI	Number of data start registers LO	Byte Count
11H	10H	40H	48H	00H	02H	04H

Value	Value LO	Value LO	Value LO	CRC HI	CRC LO
0AH	9DH	40H	89H	F1H	6AH

Response:

The normal response to a preset multi-register request includes the Acuvim II Series meter address, function code, data start register, the number of registers, and error checking.

Table 6-13 Preset Multi-Register Response Message

Address	Function	Data start register HI	Data start register LO	Number of data start registers HI	Number of data start registers LO	CRC 16 HI	CRC 16 LO
11H	10H	40H	48H	00H	02H	D6H	8EH

6.3 Data Address Table and Application Details

There are several rules to follow in using the meter:

6.3.1 Data Type

- “word” refers to 16-bit unsigned integer using one data address and 2 bytes of memory, it varies from 0 to 65535.
- “int” refers to 16-bit integer using one data address and 2 bytes of memory, it varies from -32768 to 32767.
- “dword” refers to 32-bit unsigned integer using two data addresses and 4 bytes of memory with high word at the front and low word at the end, it varies from 0 to 4294967295. Rx=high word*65536+low word.
- “float” refers to 32-bit single value using two data addresses and 4 bytes of memory, it varies from -1.175494E-38 to 3.402823E+38.

6.3.2 Relationship between communication value and numerical value.

It is important to note that the numerical value may not be the same as the communication value. The following table shows how they respond to each other.

- When current output CTs are selected, the value of CT2 is 1A or 5A, and when using the relationship listed below to count primary value, the value of CT2 should be original 1 or 5.
- When a CT has a voltage output, the value of CT2 is 333mV, and when using the relationship listed below to count primary value, the value of CT2 should not be 333, but 1.
- When using Rogowski Coil CTs (output 100mV/50Hz or 120mV/60Hz), the value of CT2 is 100. When using the relationship listed below to count the primary value, the value of CT2 should not be 100, but 1.
- When you select a 80/100/200 mA CT, the value of CT2 is 80, 100 or 200, and use the relationship listed below to count primary value, the value of CT2 should not be 80, 100 or 200, but 1.

Table 6-14 Relationship of Parameters

Parameters	Relationship	Unit	Format Code
System parameters	Numerical value equals to communication value	No unit	F1
Run-time	$T=R_x/100$	Hour	F2
Clock	Numerical value equals to communication value	Unit of time	F3
Energy (primary)	$E_p=R_x/10$	kWh	F4
Reactive energy (primary)	$E_p=R_x/10$	kvarh	F5
Apparent energy (primary)	$E_p=R_x/10$	kVA	F6
Energy (secondary)	$E_p=R_x/1000$	kWh	F7
Reactive energy (secondary)	$E_p=R_x/1000$	kvarh	F8
Apparent energy (secondary)	$E_p=R_x/1000$	kVA	F9
Frequency	$E_p=R_x/100$	Hz	F10
Voltage	$U=R_x \times (PT1/PT2)/10$	V	F11
Current, current demand	$I=R_x \times (CT1/CT2)/1000$	A	F12
Power, demand	$P=R_x \times (PT1/PT2) \times (CT1/CT2)$	W	F13
Reactive power, demand	$Q=R_x \times (PT1/PT2) \times (CT1/CT2)$	Var	F14
Apparent power, demand	$S=R_x \times (PT1/PT2) \times (CT1/CT2)$	VA	F15
Power factor	$PF=R_x/100$	No unit	F16
Unbalance factor	$Unbl=(R_x/10000) \times 100\%$	No unit	F17
THD	$THD=(R_x/10000) \times 100\%$	No unit	F18
Harmonics	$HDn=(R_x/10000) \times 100\%$	No unit	F19
Total odd HD	$HD_o=(R_x/10000) \times 100\%$	No unit	F20
Total even HD	$HD_e=(R_x/10000) \times 100\%$	No unit	F21
Crest factor	$CF=R_x/1000$	No unit	F22
K factor	$KF=R_x/10$	No unit	F23
THFF	$THFF=(R_x/10000) \times 100\%$	No unit	F24
Phase angle	Phase angle= $R_x/10$	Degree	F25

IMPORTANT NOTE: Regions from “System parameters settings” to “Data logging 3 settings” are the regions that can be set and modified. Please follow these guidelines when communicating with the meter.

- When function code 10H is used, one communication command can only modify contents in one region, such as “System parameters settings,” “System status parameter,” “Date and time table,” “Over/under limit alarming-Global settings,” “Over/under limit alarming-settings,” I/O Modules settings,” or “Data logging 1 settings, Data logging 2 settings, Data logging 3 settings.”

Modification of the contents in both of two or more regions above cannot be accomplished in a single communication.

2. When function code 03H is used, the rules and limitations described above will not be applied.

6.3.3 System Parameter Setting

System parameters determine how the meter works. Please refer to Chapter 3 and Chapter 4 for more details.

Function code: 03H for reading, 10H for writing.

Data type: word

Table 6-15

System Status 03H Read, 10H Write						
Address(H)	Address(D)	Parameter	Range	Default	Data Type	Access Property
0FFDH	4093	Frequency	0: 50Hz 1: 60Hz 2: 400Hz	0	Word	R/W
0FFEH	4094	First Communication Protocol	0: Modbus 1: DNP3.0	0	Word	R/W
0FFFH	4095	Parity for Communication Protocol 1	0: Even 1: Odd 2: Non2 3: Non1	3	Word	R/W
1000H	4096	Password	0~9999	0	Word	R/W
1001H	4097	Communication Address 1	1~247 (Modbus) 0~65534 (DNP3.0)	1	Word	R/W
1002H	4098	Baud Rate for Communication Protocol 1	1200~38400	19200	Word	R/W
1003H	4099	Voltage Input Wiring Type	0: 3LN 1: 1LN 2: 2LL 3: 3LL 4: 1LL	0	Word	R/W
1004H	4100	Current Input Wiring Type	0: 3CT 1: 1CT 2: 2CT	0	Word	R/W
1005H	4101	PT1 (High 16 bit)	50.0~500000.0	0	Word	R/W
1006H	4102	PT2 (Low 16 bit)		400	Word	R/W

System Status 03H Read, 10H Write						
Address(H)	Address(D)	Parameter	Range	Default	Data Type	Access Property
1007H	4103	PT2	50.0~400.0	400	Word	R/W
1008H	4104	CT1	1~50000	CT1 = 5, for 5A CT1 = 1, for 333mV CT1 = 1, for 80/100/200mA CT1 = 1000, for RCT	Word	R/W
1009H	4105	CT2	1(A), 5(A), 333 (333mV), 80, 100, 200 (mA)	CT2 = 5, for 5A CT2 = 333, for 333mV CT2 = 100, for 80/100/200mA CT2 = 120/60 or 100/50, for RCT	Word	R/W
100AH	4106	kWh Pulse Constant	1~60000	5000	Word	R/W
100BH	4107	kvarh Pulse Constant	1~60000	5000	Word	R/W
100CH	4108	LCD Backlight Time	0-120	1	Word	R/W
100DH	4109	Demand Sliding Window Time	1~30	15	Word	R/W
100EH	4110	Demand Calculation Mode	0: Fixed Window 1: Sliding Window 2: Thermal 3: Rolling Window	1	Word	R/W
100FH	4111	Clear Demand	Only 1 works	0	Word	R/W
1010H	4112	Max/Min Clear	Only 1 works	0	Word	R/W
1011H	4113	Run Time Clear	Only 1 works	0	Word	R/W
1012H	4114	Current I1 Direction	0: Positive 1: Negative	0	Word	R/W
1013H	4115	Current I2 Direction	0: Positive 1: Negative	0	Word	R/W
1014H	4116	Current I3 Direction	0: Positive 1: Negative	0	Word	R/W
1015H	4117	VAR/PF Convention	0: IEC 1: IEEE	0	Word	R/W
1016H	4118	Clear Energy	Only 1 works	0	Word	R/W
1017H	4119	Energy Calculation Mode	0: Fundamental 1: Full wave	1	Word	R/W

System Status 03H Read, 10H Write						
Address(H)	Address(D)	Parameter	Range	Default	Data Type	Access Property
1018H	4120	Reactive Power Measurement Mode	0: Real 1: General	0	Word	R/W
1019H	4121	Energy Display Mode	0: Primary 1: Secondary	0	Word	R/W
101AH	4122	Reset Ethernet Module	0: None 1: Reset 2: Default	0	Word	R/W
101BH	4123	Enable SOE	0: None 1: AXM-IO11 2: AXM-IO21 3: AXM-IO31 4: AXM-IO12 5: AXM-IO22 6: AXM-IO32	0	Word	R/W
101CH	4124	Clear Pulse Counter	0: None 1: AXM-IO11 2: AXM-IO21 3: AXM-IO31 4: AXM-IO12 5: AXM-IO22 6: AXM-IO32	0	Word	R/W
101DH	4125	Basic Parameter Mode	0: Secondary 1: Primary	0	Word	R/W
1020H	4128	Demand Calculation Slipping Time	1~30	1	Word	R/W

NOTE:

1. When register 0FFEh is 0, the first communication protocol is set to MODBUS. When register 0FFEh is 1, the first communication protocol is set to DNP3.0. At this time, special DNP3.0 software is needed.
2. 100AH, 100BH setting method: $1000 * 3600 / (U * I * n * \text{pulse constant}) = \text{pulse period (S)}$, pulse period calculated by the pulse constant must be greater than the pulse width (20ms ~ 1000ms) of IO module DO setting, wherein n is applied with the user, and if the three-phase signals are added, then n is 3. U and I generally equal to user settings PT2 and CT2, i.e., rated voltage and rated current.
3. 0x1017H: When selecting 400Hz type; supports full-wave only.

6.3.4 System Status Parameters

The “System status” indicates the events that have occurred in the meter, what kinds of flags are read by the user, and the index of the storage events. Flags should be cleared after being read by the controller; otherwise, new data will not be stored properly.

Function code: 03H for reading, 10H for writing.

Data type: word

Table 6-16

System Status 03H Read, 10H Write						
Address(H)	Address(D)	Parameter	Range	Default	Data Type	Access Property
101EH	4126	Sealed Non Standard Parameters	Bit0: 1st communication parameters Bit1: 2nd communication parameters Bit2: Clear Run time Bit3: DI Pulse count Bit4: TOU		Word	R/W
101FH	4127	Seal Status	0x0A: Sealed Other: Seal opened		Word	R/W
1020H	4128	Reserved			Word	R/W
1021H	4129	Clear Alarm Record	0x0A: Clear Other: Not Clear		Word	R/W
1022H-102DH	4130-4141	Reserved			Word	R/W
102EH	4142	System Status	Bit0: New alarm record Bit1: New SOE record		Word	R/W
102FH	4143	Baud Rate 2	4800~38400	38400	Word	R/W
1030H	4144	Parity 2	0: Even 1: Odd 2: Non2 3: Non1	3	Word	R/W
1031H	4145	Communication Address 2	1~247	1	Word	R/W
1032H	4146	Alarm Record Number	0: No alarming record 1~16: Last alarm record number		Word	R/W
1033H	4147	SOE Record Number	0: No SOE record 1~20: Last SOE record number		Word	R/W
1034H	4148	Run Time (High)	0~999999999		Word	R/W
1035H	4149	Run Time (Low)			Word	R/W

System Status 03H Read, 10H Write						
Address(H)	Address(D)	Parameter	Range	Default	Data Type	Access Property
1036H	4150	Expansion IO Modules Status	Bit0: AXM-IO11 Bit1: AXM-IO12 Bit2: AXM-IO21 Bit3: AXM-IO22 Bit4: AXM-IO31 Bit5: AXM-IO32 0: Disconnected 1: Connected		Word	R/W
1037H	4151	Reserved			Word	R/W
1038H	4152	2nd Communication Selection	0: Other Protocol 1: BACnet Protocol 2: Mesh Protocol 3: Wi-Fi	0	Word	R/W
1039H	4153	10 Year Holiday Setting Enable	1: Enable		Word	R/W
103AH	4154	Clear Sharp Tariff	0x0A: Clear Other: Not Clear		Word	R/W
103BH	4155	Clear Peak Tariff	0x0A: Clear Other: Not Clear		Word	R/W
103CH	4156	Clear Valley Tariff	0x0A: Clear Other: Not Clear		Word	R/W
103DH	4157	Clear Normal Tariff	0x0A: Clear Other: Not Clear		Word	R/W
103EH	4158	Clear Total	0x0A: Clear Other: Not Clear		Word	R/W

NOTE:

1. Please refer to Chapter 3 and Chapter 4 for more details about parameter settings.
2. When register 1038H is 2, second communication is set to MESH, the baud rate should be set to “9600bps,” and parity should be set to “NON1” for the second communication. When register 1038H is 1, the second communication protocol is set to BACnet protocol. When register 1038H is 0, the second communication protocol is set to other protocols, while second communication should select the second RS-485 module, PROFIBUS module, or Ethernet module. If the selected protocol does not match attached module, communication cannot process. If you use the Ethernet or PROFIBUS module, you should set 38400bps and NON1 for the second communication. While the Ethernet or PROFIBUS module will connect normally, the user cannot change the protocol, baud rate, or parity.

6.3.5 Date and Time Registers

Function code: 03H for reading, 10H for presetting.

Table 6-17

Clock Settings: 03H Read, 10H Write					
Address(H)	Address(D)	Parameter	Range	Data Type	Access Property
103FH	4159	Week	0~6	Word	R/W
1040H	4160	Year	2000~2099	Word	R/W
1041H	4161	Month	1~12	Word	R/W
1042H	4162	Day	1~31	Word	R/W
1043H	4163	Hour	0-23	Word	R/W
1044H	4164	Minute	0-59	Word	R/W
1045H	4165	Second	0-59	Word	R/W

6.3.6 100ms Refresh Metering Parameters

Table 6-18

Basic Measurements: 03H Read								
Address(H)	Address(D)	Symbol	Parameter	Parameter Mode		Property	Data Type	Access Property
				Primary Mode	Secondary Mode			
3000H-3001H	12288-12289	F	Frequency	F=Rx	F=Rx	Hz	Float	R
3002H-3003H	12290-12291	U1	Phase 1 Voltage	U=Rx	U=Rx*(PT1/PT2)	V	Float	R
3004H-3005H	12292-12293	U2	Phase 2 Voltage	U=Rx	U=Rx*(PT1/PT2)	V	Float	R
3006H-3007H	12294-12295	U3	Phase 3 Voltage	U=Rx	U=Rx*(PT1/PT2)	V	Float	R
3008H-3009H	12296-12297	Uavg	Average Phase Voltage	U=Rx	U=Rx*(PT1/PT2)	V	Float	R
300AH-300BH	12298-12299	U12	Line Voltage 1-2	U=Rx	U=Rx*(PT1/PT2)	V	Float	R
300CH-300DH	12300-12301	U23	Line Voltage 2-3	U=Rx	U=Rx*(PT1/PT2)	V	Float	R
300EH-300FH	12302-12303	U31	Line Voltage 3-1	U=Rx	U=Rx*(PT1/PT2)	V	Float	R
3010H-3011H	12304-12305	Ulavg	Average Line Voltage	U=Rx	U=Rx*(PT1/PT2)	V	Float	R

Basic Measurements: 03H Read									
Address(H)	Address(D)	Symbol	Parameter	Parameter Mode		Property	Data Type	Access Property	
				Primary Mode	Secondary Mode				
3012H-3013H	12306-12307	IL1	Total Phase A Current	I=Rx	$I=Rx*(CT1/CT2)$	A	Float	R	
3014H-3015H	12308-12309	IL2	Total Phase B Current	I=Rx	$I=Rx*(CT1/CT2)$	A	Float	R	
3016H-3017H	12310-12311	IL3	Total Phase C Current	I=Rx	$I=Rx*(CT1/CT2)$	A	Float	R	
3018H-3019H	12312-12313	Iavg	Average Phase Current	I=Rx	$I=Rx*(CT1/CT2)$	A	Float	R	
301AH-301BH	12314-12315	In	Neutral Current	I=Rx	$I=Rx*(CT1/CT2)$	A	Float	R	
301CH-301DH	12316-12317	Pa	Phase A Power	$P=Rx/1000$	$P=[Rx*(PT1/PT2)*(CT1/CT2)]/1000$	kW	Float	R	
301EH-301FH	12318-12319	Pb	Phase B Power	$P=Rx/1000$	$P=[Rx*(PT1/PT2)*(CT1/CT2)]/1000$	kW	Float	R	
3020H-3021H	12320-12321	Pc	Phase C Power	$P=Rx/1000$	$P=[Rx*(PT1/PT2)*(CT1/CT2)]/1000$	kW	Float	R	
3022H-3023H	12322-12323	Psum	Total System Power	$P=Rx/1000$	$P=[Rx*(PT1/PT2)*(CT1/CT2)]/1000$	kW	Float	R	
3024H-3025H	12324-12325	Qa	Phase A Reactive Power	$Q=Rx/1000$	$Q=[Rx*(PT1/PT2)*(CT1/CT2)]/1000$	kvar	Float	R	
3026H-3027H	12326-12327	Qb	Phase B Reactive Power	$Q=Rx/1000$	$Q=[Rx*(PT1/PT2)*(CT1/CT2)]/1000$	kvar	Float	R	
3028H-3029H	12328-12329	Qc	Phase C Reactive Power	$Q=Rx/1000$	$Q=[Rx*(PT1/PT2)*(CT1/CT2)]/1000$	kvar	Float	R	
302AH-302BH	12330-12331	Qsum	Total Reactive Power	$Q=Rx/1000$	$Q=[Rx*(PT1/PT2)*(CT1/CT2)]/1000$	kvar	Float	R	
302CH-302DH	12332-12333	Sa	Phase A Apparent Power	$S=Rx/1000$	$S=[Rx*(PT1/PT2)*(CT1/CT2)]/1000$	kVA	Float	R	
302EH-302FH	12334-12335	Sb	Phase B Apparent Power	$S=Rx/1000$	$S=[Rx*(PT1/PT2)*(CT1/CT2)]/1000$	kVA	Float	R	
3030H-3031H	12336-12337	Sc	Phase C Apparent Power	$S=Rx/1000$	$S=[Rx*(PT1/PT2)*(CT1/CT2)]/1000$	kVA	Float	R	

Basic Measurements: 03H Read								
Address(H)	Address(D)	Symbol	Parameter	Parameter Mode		Property	Data Type	Access Property
				Primary Mode	Secondary Mode			
3032H-3033H	12338-12339	Ssum	Total Apparent Power	$S=R_x/1000$	$S=[R_x*(PT1/PT2)*(CT1/CT2)]/1000$	kVA	Float	R
3034H-3035H	12340-12341	PFa	Phase A Power Factor	PF=Rx	PF=Rx		Float	R
3036H-3037H	12342-12343	PFb	Phase B Power Factor	PF=Rx	PF=Rx		Float	R
3038H-3039H	12344-12345	PFc	Phase C Power Factor	PF=Rx	PF=Rx		Float	R
3403AH-303BH	12346-12347	PFsum	Total Power Factor	PF=Rx	PF=Rx		Float	R

6.3.7 Real Time Metering Parameters

There are two, different modes to read basic analog measurements. The first is secondary mode and the other is primary mode. In primary mode, the numerical value in the register of the meter is equal to the real, physical value. In secondary mode, the relationship between the numerical value in the register and the real physical value is shown in the following table. (Rx is the numerical value in the register of the Acuvim II Series meter).

NOTE: The parameter mode Primary or Secondary corresponds to the Basic Parameter Mode (at address 101DH) in the system parameter settings. You can also configure the parameter mode from the 'S28 PARA MODE' in the system settings through the meter's display. The basic parameter mode of the meter is in Secondary Mode by default.

Table 6-19

Energy Measurements: 03H Read, 10H Write								
Address(H)	Address(D)	Symbol	Parameter	Parameter Mode		Property	Data Type	Access Property
				Primary Mode	Secondary Mode			
4000H-4001H	16384-16385	F	Frequency	F=Rx	F=Rx	Hz	Float	R
4002H-4003H	16386-16387	U1	Phase 1 Voltage	U=Rx	$U=R_x*(PT1/PT2)$	V	Float	R
4004H-4005H	16388-16389	U2	Phase 2 Voltage	U=Rx	$U=R_x*(PT1/PT2)$	V	Float	R
4006H-4007H	16390-16391	U3	Phase 3 Voltage	U=Rx	$U=R_x*(PT1/PT2)$	V	Float	R
4008H-4009H	16392-16393	Uavg	Average Phase Voltage	U=Rx	$U=R_x*(PT1/PT2)$	V	Float	R

Energy Measurements: 03H Read, 10H Write								
Address(H)	Address(D)	Symbol	Parameter	Parameter Mode		Property	Data Type	Access Property
				Primary Mode	Secondary Mode			
400AH-400BH	16394-16395	U12	Line Voltage 1-2	U=Rx	U=Rx*(PT1/PT2)	V	Float	R
400CH-400DH	16396-16397	U23	Line Voltage 2-3	U=Rx	U=Rx*(PT1/PT2)	V	Float	R
400EH-400FH	16398-16399	U31	Line Voltage 3-1	U=Rx	U=Rx*(PT1/PT2)	V	Float	R
4010H-4011H	16400-16401	Uavg	Average Line Voltage	U=Rx	U=Rx*(PT1/PT2)	V	Float	R
4012H-4013H	16402-16403	IL1	Total Phase A Current	I=Rx	I=Rx*(CT1/CT2)	A	Float	R
4014H-4015H	16404-16405	IL2	Total Phase B Current	I=Rx	I=Rx*(CT1/CT2)	A	Float	R
4016H-4017H	16406-16407	IL3	Total Phase C Current	I=Rx	I=Rx*(CT1/CT2)	A	Float	R
4018H-4019H	16408-16409	Iavg	Average Phase Current	I=Rx	I=Rx*(CT1/CT2)	A	Float	R
401AH-401BH	16410-16411	In	Neutral Current	I=Rx	I=Rx*(CT1/CT2)	A	Float	R
401CH-401DH	16412-16413	Pa	Phase A Power	P=Rx/1000	P=[Rx*(PT1/PT2)*(CT1/CT2)]/1000	kW	Float	R
401EH-401FH	16414-16415	Pb	Phase B Power	P=Rx/1000	P=[Rx*(PT1/PT2)*(CT1/CT2)]/1000	kW	Float	R
4020H-4021H	16416-16417	Pc	Phase C Power	P=Rx/1000	P=[Rx*(PT1/PT2)*(CT1/CT2)]/1000	kW	Float	R
4022H-4023H	16418-16419	Psum	Total System Power	P=Rx/1000	P=[Rx*(PT1/PT2)*(CT1/CT2)]/1000	kW	Float	R
4024H-4025H	16420-16421	Qa	Phase A Reactive Power	Q=Rx/1000	Q=[Rx*(PT1/PT2)*(CT1/CT2)]/1000	kvar	Float	R
4026H-4027H	16422-16423	Qb	Phase B Reactive Power	Q=Rx/1000	Q=[Rx*(PT1/PT2)*(CT1/CT2)]/1000	kvar	Float	R
4028H-4029H	16424-16425	Qc	Phase C Reactive Power	Q=Rx/1000	Q=[Rx*(PT1/PT2)*(CT1/CT2)]/1000	kvar	Float	R
402AH-402BH	16426-16427	Qsum	Total Reactive Power	Q=Rx/1000	Q=[Rx*(PT1/PT2)*(CT1/CT2)]/1000	kvar	Float	R

Energy Measurements: 03H Read, 10H Write								
Address(H)	Address(D)	Symbol	Parameter	Parameter Mode		Property	Data Type	Access Property
				Primary Mode	Secondary Mode			
402CH-402DH	16428-16429	Sa	Phase A Apparent Power	$S=R_x/1000$	$S=[R_x*(PT1/PT2)*(CT1/CT2)]/1000$	kVA	Float	R
402EH-402FH	16430-16431	Sb	Phase B Apparent Power	$S=R_x/1000$	$S=[R_x*(PT1/PT2)*(CT1/CT2)]/1000$	kVA	Float	R
4030H-4031H	16432-16433	Sc	Phase C Apparent Power	$S=R_x/1000$	$S=[R_x*(PT1/PT2)*(CT1/CT2)]/1000$	kVA	Float	R
4032H-4033H	16434-16435	Ssum	Total Apparent Power	$S=R_x/1000$	$S=[R_x*(PT1/PT2)*(CT1/CT2)]/1000$	kVA	Float	R
4034H-4035H	16436-16437	PFa	Phase A Power Factor	$PF=R_x$	$PF=R_x$		Float	R
4036H-4037H	16438-16439	PFb	Phase B Power Factor	$PF=R_x$	$PF=R_x$		Float	R
4038H-4039H	16440-16441	PFc	Phase C Power Factor	$PF=R_x$	$PF=R_x$		Float	R
403AH-403BH	16442-16443	PFsum	Total Power Factor	$PF=R_x$	$PF=R_x$		Float	R
403CH-403DH	16444-16445	U_unbl	Voltage Unbalance	$U=R_x*100\%$	$U=R_x*100\%$	%	Float	R
403EH-403FH	16446-16447	I_unbl	Current Unbalance	$I=R_x*100\%$	$I=R_x*100\%$	%	Float	R
4040H-4041H	16448-16449	L/C/R	Load Characteristic	76.0(L) 67.0(C) 82.0(R)	76.0(L) 67.0(C) 82.0(R)		Float	R
4042H-4043H	16450-16451	P_Dmd	Power Demand	$P=R_x/1000$	$P=[R_x*(PT1/PT2)*(CT1/CT2)]/1000$	kW	Float	R
4044H-4045H	16452-16453	Q_Dmd	Reactive Power Demand	$S=R_x/1000$	$S=[R_x*(PT1/PT2)*(CT1/CT2)]/1000$	kVA	Float	R
4046H-4047H	16454-16455	S_Dmd	Apparent Power Demand	$Q=R_x/1000$	$Q=[R_x*(PT1/PT2)*(CT1/CT2)]/1000$	kvar	Float	R
4600H-4601H	17920-17921	I1_Dmd	Phase A Current Demand	$I=R_x$	$I=R_x*(CT1/CT2)$	A	Float	R
4602H-4603H	17922-17923	I2_Dmd	Phase B Current Demand	$I=R_x$	$I=R_x*(CT1/CT2)$	A	Float	R
4604H-4605H	17924-17925	I3_Dmd	Phase C Current Demand	$I=R_x$	$I=R_x*(CT1/CT2)$	A	Float	R

6.3.8 Energy Parameters

NOTE: The Energy Display option of either Primary Mode or Secondary Mode corresponds to the Energy Display Mode (at address 1019H) in the system parameter settings. You can also configure the energy display mode from the 'S24 E SEL' in the system settings through the meters display. The energy display mode is in Primary Mode by default.

Table 6-20

Energy Measurements: 03H Read, 10H Write								
Address(H)	Address(D)	Symbol	Parameter	Parameter Mode		Property	Data Type	Access Property
				Primary Mode	Secondary Mode			
4048H-4049H	16456-16457	Ep_imp	Consumed Energy	Ep_imp=Rx/10	Ep_imp=Rx/1000	0~999999999	kWh	R/W
404AH-404BH	16458-16459	Ep_exp	Generated Energy	Ep_exp=Rx/10	Ep_exp=Rx/1000	0~999999999	kWh	R/W
404CH-404DH	16460-16461	Eq_imp	Consumed Reactive Energy	Eq_imp=Rx/10	Eq_imp=Rx/1000	0~999999999	kvarh	R/W
404EH-404FH	16462-16463	Eq_exp	Generated Reactive Energy	Eq_exp=Rx/10	Eq_exp=Rx/1000	0~999999999	kvarh	R/W
4050H-4051H	16464-16465	Ep_sum	Total Energy	Ep_sum=Rx/10	Ep_sum=Rx/1000	0~999999999	kWh	R/W
4052H-4053H	16466-16467	Ep_net	Net Energy	Ep_net=Rx/10	Ep_net=Rx/1000	±999999999	kWh	R/W
4054H-4055H	16468-16469	Eq_sum	Total Reactive Energy	Eq_sum=Rx/10	Eq_sum=Rx/1000	0~999999999	kvarh	R/W
4056H-4057H	16470-16471	Eq_net	Net Reactive Energy	Eq_net=Rx/10	Eq_net=Rx/1000	±999999999	kvarh	R/W
4058H-4059H	16472-16473	Es	Apparent Energy	Es=Rx/10	Es=Rx/1000	0~999999999	kVAh	R/W
4620H-4621H	17952-17953	Epa_imp	Phase A Consumed Energy	Epa_imp=Rx/10	Epa_imp=Rx/1000	0~999999999	kWh	R/W
4622H-4623H	17954-17955	Epa_exp	Phase A Generated Energy	Epa_exp=Rx/10	Epa_exp=Rx/1000	0~999999999	kWh	R/W
4624H-4625H	17956-17957	Epb_imp	Phase B Consumed Energy	Epb_imp=Rx/10	Epb_imp=Rx/1000	0~999999999	kWh	R/W
4626H-4627H	17958-17959	Epb_exp	Phase B Generated Energy	Epb_exp=Rx/10	Epb_exp=Rx/1000	0~999999999	kWh	R/W

Energy Measurements: 03H Read, 10H Write								
Address(H)	Address(D)	Symbol	Parameter	Parameter Mode		Property	Data Type	Access Property
				Primary Mode	Secondary Mode			
4628H-4629H	17960-17961	Epc_Imp	Phase C Consumed Energy	Epc_Imp=Rx/10	Epc_Imp=Rx/1000	0~999999999	kWh	R/W
462AH-462BH	17962-17963	Epc_Exp	Phase C Generated Energy	Epc_Exp=Rx/10	Epc_Exp=Rx/1000	0~999999999	kWh	R/W
462CH-462DH	17964-17965	Eqa_Imp	Phase A Consumed Reactive Energy	Eqa_Imp=Rx/10	Eqa_Imp=Rx/1000	0~999999999	kvarh	R/W
462EH-462FH	17966-17967	Eqa_Exp	Phase A Generated Reactive Energy	Eqa_Exp=Rx/10	Eqa_Exp=Rx/1000	0~999999999	kvarh	R/W
4630H-4631H	17968-17969	Eqb_Imp	Phase B Consumed Reactive Energy	Eqb_Imp=Rx/10	Eqb_Imp=Rx/1000	0~999999999	kvarh	R/W
4632H-4633H	17970-17971	Eqb_Exp	Phase B Generated Reactive Energy	Eqb_Exp=Rx/10	Eqb_Exp=Rx/1000	0~999999999	kvarh	R/W
4634H-4635H	17972-17973	Eqc_Imp	Phase C Consumed Reactive Energy	Eqc_Imp=Rx/10	Eqc_Imp=Rx/1000	0~999999999	kvarh	R/W
4636H-4637H	17974-17975	Eqc_Exp	Phase C Generated Reactive Energy	Eqc_Exp=Rx/10	Eqc_Exp=Rx/1000	0~999999999	kvarh	R/W
4638H-4639H	17976-17977	Esa	Phase A Apparent Energy	Esa=Rx/10	Esa=Rx/1000	0~999999999	kVA	R/W
463AH-463BH	17978-17979	Esb	Phase B Apparent Energy	Esb=Rx/10	Esb=Rx/1000	0~999999999	kVA	R/W
463CH-463DH	17980-17981	Esc	Phase C Apparent Energy	Esc=Rx/10	Esc=Rx/1000	0~999999999	kVA	R/W

6.3.9 TOU (Time-of-Use) Registers

Current Month Accumulation TOU Energy

Table 6-21

Current month accumulation TOU Energy: 03H Read, 10H Write							
Address(H)	Address(D)	Symbol	Parameter	Range	Property	Data Type	Access Property
Sharp							
7200H-7201H	29184-29185	Ep_Imp	Consumed Energy	0-999999999	kWh	Dword	R/W
7202H-7203H	29186-29187	Ep_Exp	Generated Energy	0-999999999	kWh	Dword	R/W
7204H-7205H	29188-29189	Eq_Imp	Consumed Reactive Energy	0-999999999	kvarh	Dword	R/W
7206H-7207H	29190-29191	Eq_Exp	Generated Reactive Energy	0-999999999	kvarh	Dword	R/W
7208H-7209H	29192-29193	Es	Apparent Energy	0-999999999	kVAh	Dword	R/W
Peak							
720AH-720BH	29194-29195	Ep_Imp	Consumed Energy	0-999999999	kWh	Dword	R/W
720CH-720DH	29196-29197	Ep_Exp	Generated Energy	0-999999999	kWh	Dword	R/W
720EH-720FH	29198-29199	Eq_Imp	Consumed Reactive Energy	0-999999999	kvarh	Dword	R/W
7210H-7211H	29200-29201	Eq_Exp	Generated Reactive Energy	0-999999999	kvarh	Dword	R/W
7212H-7213H	29202-29203	Es	Apparent Energy	0-999999999	kVAh	Dword	R/W
Valley							
7214H-7215H	29204-29205	Ep_Imp	Consumed Energy	0-999999999	kWh	Dword	R/W
7216H-7217H	29206-29207	Ep_Exp	Generated Energy	0-999999999	kWh	Dword	R/W
7218H-7219H	29208-29209	Eq_Imp	Consumed Reactive Energy	0-999999999	kvarh	Dword	R/W
721AH-721BH	29210-29211	Eq_Exp	Generated Reactive Energy	0-999999999	kvarh	Dword	R/W
721CH-721DH	29212-29213	Es	Apparent Energy	0-999999999	kVAh	Dword	R/W
Normal							
721EH-721FH	29214-29215	Ep_Imp	Consumed Energy	0-999999999	kWh	Dword	R/W

Current month accumulation TOU Energy: 03H Read, 10H Write							
Address(H)	Address(D)	Symbol	Parameter	Range	Property	Data Type	Access Property
7220H-7221H	29216-29217	Ep_Exp	Generated Energy	0-999999999	kWh	Dword	R/W
7222H-7223H	29218-29219	Eq_Imp	Consumed Reactive Energy	0-999999999	kvarh	Dword	R/W
7224H-7225H	29220-29221	Eq_Exp	Generated Reactive Energy	0-999999999	kvarh	Dword	R/W
7226H-7227H	29222-29223	Es	Apparent Energy	0-999999999	kVAh	Dword	R/W
Total							
7228H-7229H	29224-29225	Ep_Imp	Consumed Energy	0-999999999	kWh	Dword	R/W
722AH-722BH	29226-29227	Ep_Exp	Generated Energy	0-999999999	kWh	Dword	R/W
722CH-722DH	29228-29229	Eq_Imp	Consumed Reactive Energy	0-999999999	kvarh	Dword	R/W
722EH-722FH	29230-29231	Eq_Exp	Generated Reactive Energy	0-999999999	kvarh	Dword	R/W
7230H-7231H	29232-29233	Es	Apparent Energy	0-999999999	kVAh	Dword	R/W

Prior Month Accumulation TOU Energy

Table 6-22

Prior Month Accumulation TOU Energy: 03H Read, 10H Write							
Address(H)	Address(D)	Symbol	Parameter	Range	Property	Data Type	Access Property
Sharp							
7232H-7233H	29234-29235	Ep_Imp	Consumed Energy	0-999999999	kWh	Dword	R/W
7234H-7235H	29236-29237	Ep_Exp	Generated Energy	0-999999999	kWh	Dword	R/W
7236H-7237H	29238-29239	Eq_Imp	Consumed Reactive Energy	0-999999999	kvarh	Dword	R/W
7238H-7239H	29240-29241	Eq_Exp	Generated Reactive Energy	0-999999999	kvarh	Dword	R/W
723AH-723BH	29242-29243	Es	Apparent Energy	0-999999999	kVAh	Dword	R/W
Peak							
723CH-723DH	29244-29245	Ep_Imp	Consumed Energy	0-999999999	kWh	Dword	R/W

Prior Month Accumulation TOU Energy: 03H Read, 10H Write							
Address(H)	Address(D)	Symbol	Parameter	Range	Property	Data Type	Access Property
723EH-723FH	29246-29247	Ep_Exp	Generated Energy	0-999999999	kWh	Dword	R/W
7240H-7241H	29248-29249	Eq_Imp	Consumed Reactive Energy	0-999999999	kvarh	Dword	R/W
7242H-7243H	29250-29251	Eq_Exp	Generated Reactive Energy	0-999999999	kvarh	Dword	R/W
7244H-7245H	29252-29253	Es	Apparent Energy	0-999999999	kVAh	Dword	R/W
Valley							
7246H-7247H	29254-29255	Ep_Imp	Consumed Energy	0-999999999	kWh	Dword	R/W
7248H-7249H	29256-29257	Ep_Exp	Generated Energy	0-999999999	kWh	Dword	R/W
724AH-724BH	29258-29259	Eq_Imp	Consumed Reactive Energy	0-999999999	kvarh	Dword	R/W
724CH-724DH	29260-29261	Eq_Exp	Generated Reactive Energy	0-999999999	kvarh	Dword	R/W
724EH-724FH	29262-29263	Es	Apparent Energy	0-999999999	kVAh	Dword	R/W
Normal							
7250H-7251H	29264-29265	Ep_Imp	Consumed Energy	0-999999999	kWh	Dword	R/W
7252H-7253H	29266-29267	Ep_Exp	Generated Energy	0-999999999	kWh	Dword	R/W
7254H-7255H	29268-29269	Eq_Imp	Consumed Reactive Energy	0-999999999	kvarh	Dword	R/W
7256H-7257H	29270-29271	Eq_Exp	Generated Reactive Energy	0-999999999	kvarh	Dword	R/W
7258H-7259H	29272-29273	Es	Apparent Energy	0-999999999	kVAh	Dword	R/W
Total							
725AH-725BH	29274-29275	Ep_Imp	Consumed Energy	0-999999999	kWh	Dword	R/W
725CH-725DH	29276-29277	Ep_Exp	Generated Energy	0-999999999	kWh	Dword	R/W
725EH-725FH	29278-29279	Eq_Imp	Consumed Reactive Energy	0-999999999	kvarh	Dword	R/W
7260H-7261H	29280-29281	Eq_Exp	Generated Reactive Energy	0-999999999	kvarh	Dword	R/W
7262H-7263H	29282-29283	Es	Apparent Energy	0-999999999	kVAh	Dword	R/W

Current Month Incremental TOU Energy

Table 6-23

Current Month Incremental TOU Energy: 03H Read, 10H Write							
Address(H)	Address(D)	Symbol	Parameter	Range	Property	Data Type	Access Property
Sharp							
7300H-7301H	29440-29441	Ep_Imp	Consumed Energy	0-999999999	kWh	Dword	R/W
7302H-7303H	29442-29443	Ep_Exp	Generated Energy	0-999999999	kWh	Dword	R/W
7304H-7305H	29444-29445	Eq_Imp	Consumed Reactive Energy	0-999999999	kvarh	Dword	R/W
7306H-7307H	29446-29447	Eq_Exp	Generated Reactive Energy	0-999999999	kvarh	Dword	R/W
7308H-7309H	29448-29449	Es	Apparent	0-999999999	kVAh	Dword	R/W
Peak							
730AH-730BH	29450-29451	Ep_Imp	Consumed Energy	0-999999999	kWh	Dword	R/W
730CH-730DH	29452-29453	Ep_Exp	Generated Energy	0-999999999	kWh	Dword	R/W
730EH-730FH	29454-29455	Eq_Imp	Consumed Reactive Energy	0-999999999	kvarh	Dword	R/W
7310H-7311H	29456-29457	Eq_Exp	Generated Reactive Energy	0-999999999	kvarh	Dword	R/W
7312H-7313H	29458-29459	Es	Apparent Energy	0-999999999	kVAh	Dword	R/W
Valley							
7314H-7315H	29460-29461	Ep_Imp	Consumed Energy	0-999999999	kWh	Dword	R/W
7316H-7317H	29462-29463	Ep_Exp	Exported Energy	0-999999999	kWh	Dword	R/W
7318H-7319H	29464-29465	Eq_Imp	Consumed Reactive Energy	0-999999999	kvarh	Dword	R/W
731AH-731BH	29466-29467	Eq_Exp	Generated Reactive Energy	0-999999999	kvarh	Dword	R/W
731CH-731DH	29468-29469	Es	Apparent Energy	0-999999999	kVAh	Dword	R/W
Normal							
731EH-731FH	29470-29741	Ep_Imp	Consumed Energy	0-999999999	kWh	Dword	R/W

Current Month Incremental TOU Energy: 03H Read, 10H Write							
Address(H)	Address(D)	Symbol	Parameter	Range	Property	Data Type	Access Property
7320H-7321H	29472-29473	Ep_Exp	Generated Energy	0-999999999	kWh	Dword	R/W
7322H-7323H	29474-29475	Eq_Imp	Consumed Reactive Energy	0-999999999	kvarh	Dword	R/W
7324H-7325H	29476-29477	Eq_Exp	Generated Reactive Energy	0-999999999	kvarh	Dword	R/W
7326H-7327H	29478-29479	Es	Apparent Energy	0-999999999	kVAh	Dword	R/W
Total							
7328H-7329H	29480-29481	Ep_Imp	Consumed Energy	0-999999999	kWh	Dword	R/W
732AH-732BH	29482-29483	Ep_Exp	Exported Energy	0-999999999	kWh	Dword	R/W
732CH-732DH	29484-29485	Eq_Imp	Consumed Reactive Energy	0-999999999	kvarh	Dword	R/W
732EH-732FH	29486-29487	Eq_Exp	Generated Reactive Energy	0-999999999	kvarh	Dword	R/W
7330H-7331H	29488-29489	Es	Apparent Energy	0-999999999	kVAh	Dword	R/W

Prior Month Incremental TOU Energy

Table 6-24

Prior Month Incremental TOU Energy: 03H Read, 10H Write							
Address(H)	Address(D)	Symbol	Parameter	Range	Property	Data Type	Access Property
Sharp							
7332H-7333H	29490-29491	Ep_Imp	Consumed Energy	0-999999999	kWh	Dword	R/W
7334H-7335H	29492-29493	Ep_Exp	Generated Energy	0-999999999	kWh	Dword	R/W
7336H-7337H	29494-29495	Eq_Imp	Consumed Reactive Energy	0-999999999	kvarh	Dword	R/W
7338H-7339H	29496-29497	Eq_Exp	Generated Reactive Energy	0-999999999	kvarh	Dword	R/W
733AH-733BH	29498-29499	Es	Apparent Energy	0-999999999	kVAh	Dword	R/W
Peak							
733CH-733DH	29500-29501	Ep_Imp	Consumed Energy	0-999999999	kWh	Dword	R/W

Acuvim II Series Power Meter

Prior Month Incremental TOU Energy: 03H Read, 10H Write							
Address(H)	Address(D)	Symbol	Parameter	Range	Property	Data Type	Access Property
733EH-733FH	29502-29503	Ep_Exp	Generated Energy	0-999999999	kWh	Dword	R/W
7340H-7341H	29504-29505	Eq_Imp	Consumed Reactive Energy	0-999999999	kvarh	Dword	R/W
7342H-7343H	29506-29507	Eq_Exp	Generated Reactive Energy	0-999999999	kvarh	Dword	R/W
7344H-7345H	29508-29509	Es	Apparent Energy	0-999999999	kVAh	Dword	R/W
Valley							
7346H-7347H	29510-29511	Ep_Imp	Consumed Energy	0-999999999	kWh	Dword	R/W
7348H-7349H	29512-29513	Ep_Exp	Generated Energy	0-999999999	kWh	Dword	R/W
734AH-734BH	29514-29515	Eq_Imp	Consumed Reactive Energy	0-999999999	kvarh	Dword	R/W
734CH-734DH	29516-29517	Eq_Exp	Generated Reactive Energy	0-999999999	kvarh	Dword	R/W
734EH-734FH	29518-29519	Es	Apparent Energy	0-999999999	kVA	Dword	R/W
Normal							
7350H-7351H	29520-29521	Ep_Imp	Consumed Energy	0-999999999	kWh	Dword	R/W
7352H-7353H	29522-29523	Ep_Exp	Generated Energy	0-999999999	kWh	Dword	R/W
7354H-7355H	29524-29525	Eq_Imp	Consumed Reactive Energy	0-999999999	kvarh	Dword	R/W
7356H-7357H	29526-29527	Eq_Exp	Generated Reactive Energy	0-999999999	kvarh	Dword	R/W
7358H-7359H	29528-29529	Es	Apparent Energy	0-999999999	kVAh	Dword	R/W
Total							
735AH-735BH	29530-29531	Ep_Imp	Consumed Energy	0-999999999	kWh	Dword	R/W
735CH-735DH	29532-29533	Ep_Exp	Generated Energy	0-999999999	kWh	Dword	R/W
735EH-735FH	29534-29535	Eq_Imp	Consumed Reactive Energy	0-999999999	kvarh	Dword	R/W
7360H-7361H	29536-29537	Eq_Exp	Generated Reactive Energy	0-999999999	kvarh	Dword	R/W
7363H-7363H	29538-29539	Es	Apparent Energy	0-999999999	kVAh	Dword	R/W

Current Month Maximum Demand TOU

Table 6-25

Current Month Maximum Demand TOU Energy: 03H Read, 10H Write							
Address(H)	Address(D)	Symbol	Parameter	Relationship	Range	Data Type	Access Property
Sharp							
7500H	29952	Ep_Imp	Max Demand	Rx/10	32768~32767	Int	R
7501H-7503H	29956		Timestamp	YY/MM; DD/HH; Min/Sec			
7504H	29956	Ep_Exp	Max Demand	Rx/10	32768~32767	Int	R
7505H-7507H	29957- 29959		Timestamp	YY/MM; DD/HH; Min/Sec			
7508H	29960	Eq_Imp	Max Demand	Rx/10	32768~32767	Int	R
7509H-750BH	29961- 29963		Timestamp	YY/MM; DD/HH; Min/Sec			
750CH	29964	Eq_Exp	Max Demand	Rx/10	32768~32767	Int	R
750DH-750FH	29965- 29967		Timestamp	YY/MM; DD/HH; Min/Sec			
7510H	29968	Es	Max Demand	Rx/10	32768~32767	Int	R
7511H-7513H	29969- 29971		Timestamp	YY/MM; DD/HH; Min/Sec			
7514H	29972	la	Max Demand	Rx*(CT1/ CT2)/1000	32768~32767	Int	R
7515H-7517H	29973- 29975		Timestamp	YY/MM; DD/HH; Min/Sec			
7518H	29976	lb	Max Demand	Rx*(CT1/ CT2)/1000	32768~32767	Int	R
7519H-751BH	29977- 29979		Timestamp	YY/MM; DD/HH; Min/Sec			
751CH	29980	lc	Max Demand	Rx*(CT1/ CT2)/1000	32768~32767	Int	R

AccuVim II Series Power Meter

Current Month Maximum Demand TOU Energy: 03H Read, 10H Write							
Address(H)	Address(D)	Symbol	Parameter	Relationship	Range	Data Type	Access Property
751DH-751FH	29981-29983		Timestamp	YY/MM; DD/HH; Min/Sec			
Peak							
7520H	29984	Ep_Imp	Max Demand	Rx/10	32768~32767	Int	R
7521H-7523H	29985-29987		Timestamp	YY/MM; DD/HH; Min/Sec			
7524H	29988	Ep_Exp	Max Demand	Rx/10	32768~32767	Int	R
7525H-7527H	29989-29991		Timestamp	YY/MM; DD/HH; Min/Sec			
7528H	29992	Eq_Imp	Max Demand	Rx/10	32768~32767	Int	R
7529H-752BH	29993-29995		Timestamp	YY/MM; DD/HH; Min/Sec			
752CH	29996	Eq_Exp	Max Demand	Rx/10	32768~32767	Int	R
752DH-752FH	29997-29999		Timestamp	YY/MM; DD/HH; Min/Sec			
7530H	30000	Es	Max Demand	Rx/10	32768~32767	Int	R
7531H-7533H	30001-30003		Timestamp	YY/MM; DD/HH; Min/Sec			
7534H	30004	la	Max Demand	Rx*(CT1/ CT2)/1000	32768~32767	Int	R
7535H-7537H	30005-30007		Timestamp	YY/MM; DD/HH; Min/Sec			
7538H	30008	lb	Max Demand	Rx*(CT1/ CT2)/1000	32768~32767	Int	R
7539H-753BH	30009-30011		Timestamp	YY/MM; DD/HH; Min/Sec			
753CH	30012	lc	Max Demand	Rx*(CT1/ CT2)/1000	32768~32767	Int	R

Current Month Maximum Demand TOU Energy: 03H Read, 10H Write							
Address(H)	Address(D)	Symbol	Parameter	Relationship	Range	Data Type	Access Property
753DH-753FH	30013-30015		Timestamp	YY/MM; DD/HH; Min/Sec			
Valley							
7540H	30016	Ep_Imp	Max Demand	Rx/10	32768~32767	Int	R
7541H-7543H	30017-30019		Timestamp	YY/MM; DD/HH; Min/Sec			
7544H	30020	Ep_Exp	Max Demand	Rx/10	32768~32767	Int	R
7545H-7547H	30021-30023		Timestamp	YY/MM; DD/HH; Min/Sec			
7548H	30024	Eq_Imp	Max Demand	Rx/10	32768~32767	Int	R
7549H-754BH	30025-30026		Timestamp	YY/MM; DD/HH; Min/Sec			
754CH	30027	Eq_Exp	Max Demand	Rx/10	32768~32767	Int	R
754DH-754FH	30028-30031		Timestamp	YY/MM; DD/HH; Min/Sec			
7550H	30032	Es	Max Demand	Rx/10	32768~32767	Int	R
7551H-7553H	30033-30035		Timestamp	YY/MM; DD/HH; Min/Sec			
7554H	30036	la	Max Demand	Rx*(CT1/ CT2)/1000	32768~32767	Int	R
7555H-7557H	30037-30039		Timestamp	YY/MM; DD/HH; Min/Sec			
7558H	30040	lb	Max Demand	Rx*(CT1/ CT2)/1000	32768~32767	Int	R
7559H-755BH	30041-30043		Timestamp	YY/MM; DD/HH; Min/Sec			
755CH	30044	lc	Max Demand	Rx*(CT1/ CT2)/1000	32768~32767	Int	R

Acuvim II Series Power Meter

Current Month Maximum Demand TOU Energy: 03H Read, 10H Write							
Address(H)	Address(D)	Symbol	Parameter	Relationship	Range	Data Type	Access Property
755DH-755FH	30045-30047		Timestamp	YY/MM; DD/HH; Min/Sec			
Normal							
7560H	30048	Ep_Imp	Max Demand	Rx/10	32768~32767	Int	R
7561H-7563H	30049-30051		Timestamp	YY/MM; DD/HH; Min/Sec			
7564H	30052	Ep_Exp	Max Demand	Rx/10	32768~32767	Int	R
7565H-7567H	30053-30055		Timestamp	YY/MM; DD/HH; Min/Sec			
7568H	30056	Eq_Imp	Max Demand	Rx/10	32768~32767	Int	R
7569H-756BH	30057-30059		Timestamp	YY/MM; DD/HH; Min/Sec			
756CH	30060	Eq_Exp	Max Demand	Rx/10	32768~32767	Int	R
756DH-756FH	30061-30063		Timestamp	YY/MM; DD/HH; Min/Sec			
7570H	30064	Es	Max Demand	Rx/10	32768~32767	Int	R
7571H-7573H	30065-30067		Timestamp	YY/MM; DD/HH; Min/Sec			
7574H	30068	la	Max Demand	Rx*(CT1/ CT2)/1000	32768~32767	Int	R
7575H-7577H	30069-30071		Timestamp	YY/MM; DD/HH; Min/Sec			
7578H	30072	lb	Max Demand	Rx*(CT1/ CT2)/1000	32768~32767	Int	R
7579H-757BH	30073-30075		Timestamp	YY/MM; DD/HH; Min/Sec			
757CH	30076	lc	Max Demand	Rx*(CT1/ CT2)/1000	32768~32767	Int	R

Current Month Maximum Demand TOU Energy: 03H Read, 10H Write							
Address(H)	Address(D)	Symbol	Parameter	Relationship	Range	Data Type	Access Property
757DH-757FH	30077-30079		Timestamp	YY/MM; DD/HH; Min/Sec			
Total							
7580H	30080	Ep_Imp	Max Demand	Rx/10	32768~32767	Int	R
7581H-7583H	30081-30083		Timestamp	YY/MM; DD/HH; Min/Sec			
7584H	30084	Ep_Exp	Max Demand	Rx/10	32768~32767	Int	R
7585H-7587H	30085-30087		Timestamp	YY/MM; DD/HH; Min/Sec			
7588H	30088	Eq_Imp	Max Demand	Rx/10	32768~32767	Int	R
7589H-758BH	30089-30091		Timestamp	YY/MM; DD/HH; Min/Sec			
758CH	30092	Eq_Exp	Max Demand	Rx/10	32768~32767	Int	R
758DH-758FH	30093-30095		Timestamp	YY/MM; DD/HH; Min/Sec			
7590H	30096	Es	Max Demand	Rx/10	32768~32767	Int	R
7591H-7593H	30097-30099		Timestamp	YY/MM; DD/HH; Min/Sec			
7594H	30100	la	Max Demand	Rx*(CT1/ CT2)/1000	32768~32767	Int	R
7595H-7597H	30101-30103		Timestamp	YY/MM; DD/HH; Min/Sec			
7598H	30104	lb	Max Demand	Rx*(CT1/ CT2)/1000	32768~32767	Int	R
7599H-759BH	30105-30107		Timestamp	YY/MM; DD/HH; Min/Sec			
759CH	30108	lc	Max Demand	Rx*(CT1/ CT2)/1000	32768~32767	Int	R

Current Month Maximum Demand TOU Energy: 03H Read, 10H Write							
Address(H)	Address(D)	Symbol	Parameter	Relationship	Range	Data Type	Access Property
759DH-759FH	30109-30111		Timestamp	YY/MM; DD/HH; Min/Sec			

Prior Month Maximum Demand

Table 6-26

Previous Month Maximum Demand TOU Energy: 03H, 10H Write							
Address(H)	Address(D)	Symbol	Parameter	Relationship	Range	Data Type	Access Property
Sharp							
7600H	30208	Ep_Imp	Max Demand	Rx/10	32768~32767	Int	R
7601H-7603H	30209-30211		Timestamp	YY/MM; DD/HH; Min/Sec			
7604H	30212	Ep_Exp	Max Demand	Rx/10	32768~32767	Int	R
7605H-7607H	30213-30215		Timestamp	YY/MM; DD/HH; Min/Sec			
7608H	30216	Eq_Imp	Max Demand	Rx/10	32768~32767	Int	R
7609H-760BH	30217-30219		Timestamp	YY/MM; DD/HH; Min/Sec			
760CH	30220	Ep_Exp	Max Demand	Rx/10	32768~32767	Int	R
760DH-760FH	30221-30223		Timestamp	YY/MM; DD/HH; Min/Sec			
7610H	30224	Es	Max Demand	Rx/10	32768~32767	Int	R
7611H-7613H	30225-30227		Timestamp	YY/MM; DD/HH; Min/Sec			
7614H	30228	Ia	Max Demand	Rx*(CT1/ CT2)/1000	32768~32767	Int	R
7615H-7617H	30229-30231		Timestamp	YY/MM; DD/HH; Min/Sec			

Previous Month Maximum Demand TOU Energy: 03H, 10H Write							
Address(H)	Address(D)	Symbol	Parameter	Relationship	Range	Data Type	Access Property
7618H	30232	lb	Max Demand	Rx*(CT1/ CT2)/1000	32768~32767	Int	R
7619H-761BH	30233- 30235		Timestamp	YY/MM; DD/HH; Min/Sec			
761CH	30236	lc	Max Demand	Rx*(CT1/ CT2)/1000	32768~32767	Int	R
761DH-761FH	30237- 30239		Timestamp	YY/MM; DD/HH; Min/Sec			
Peak							
7620H	30240	Ep_Imp	Max Demand	Rx/10	32768~32767	Int	R
7621H-7623H	30241- 30243		Timestamp	YY/MM; DD/HH; Min/Sec			
7624H	30244	Ep_Exp	Max Demand	Rx/10	32768~32767	Int	R
7625H-7627H	30245- 30247		Timestamp	YY/MM; DD/HH; Min/Sec			
7628H	30248	Eq_Imp	Max Demand	Rx/10	32768~32767	Int	R
7629H-762BH	30249- 30251		Timestamp	YY/MM; DD/HH; Min/Sec			
762CH	30252	Eq_Exp	Max Demand	Rx/10	32768~32767	Int	R
762DH-762FH	30253- 30255		Timestamp	YY/MM; DD/HH; Min/Sec			
7630H	30256	Es	Max Demand	Rx/10	32768~32767	Int	R
7631H-7633H	30257- 30259		Timestamp	YY/MM; DD/HH; Min/Sec			
7634H	30260	la	Max Demand	Rx*(CT1/ CT2)/1000	32768~32767	Int	R
7635H-7637H	30261- 30263		Timestamp	YY/MM; DD/HH; Min/Sec			

AccuVim II Series Power Meter

Previous Month Maximum Demand TOU Energy: 03H, 10H Write							
Address(H)	Address(D)	Symbol	Parameter	Relationship	Range	Data Type	Access Property
7638H	30264	lb	Max Demand	Rx*(CT1/CT2)/1000	32768~32767	Int	R
7639H-763BH	30265-30267		Timestamp	YY/MM; DD/HH; Min/Sec			
763CH	30268	lc	Max Demand	Rx*(CT1/CT2)/1000	32768~32767	Int	R
763DH-763FH	30269-30271		Timestamp	YY/MM; DD/HH; Min/Sec			
Valley							
7640H	30272	Ep_Imp	Max Demand	Rx/10	32768~32767	Int	R
7641H-7643H	30273-30275		Timestamp	YY/MM; DD/HH; Min/Sec			
7644H	30276	Ep_Exp	Max Demand	Rx/10	32768~32767	Int	R
7645H-7647H	30277-30279		Timestamp	YY/MM; DD/HH; Min/Sec			
7648H	30280	Eq_Imp	Max Demand	Rx/10	32768~32767	Int	R
7649H-764BH	30281-30283		Timestamp	YY/MM; DD/HH; Min/Sec			
764CH	30284	Eq_Exp	Max Demand	Rx/10	32768~32767	Int	R
764DH-764FH	30285-30287		Timestamp	YY/MM; DD/HH; Min/Sec			
7650H	30288	Es	Max Demand	Rx/10	32768~32767	Int	R
7651H-7653H	30289-30291		Timestamp	YY/MM; DD/HH; Min/Sec			
7654H	30292	la	Max Demand	Rx*(CT1/CT2)/1000	32768~32767	Int	R
7655H-7657H	30293-30295		Timestamp	YY/MM; DD/HH; Min/Sec			

Previous Month Maximum Demand TOU Energy: 03H, 10H Write							
Address(H)	Address(D)	Symbol	Parameter	Relationship	Range	Data Type	Access Property
7658H	30296	lb	Max Demand	Rx*(CT1/ CT2)/1000	32768~32767	Int	R
7659H-765BH	30297- 30299		Timestamp	YY/MM; DD/HH; Min/Sec			
765CH	30300	lc	Max Demand	Rx*(CT1/ CT2)/1000	32768~32767	Int	R
765DH-765FH	30301- 30303		Timestamp	YY/MM; DD/HH; Min/Sec			
Normal							
7660H	30304	Ep_Imp	Max Demand	Rx/10	32768~32767	Int	R
7661H-7663H	30305- 30307		Timestamp	YY/MM; DD/HH; Min/Sec			
7664H	30308	Ep_Exp	Max Demand	Rx/10	32768~32767	Int	R
7665H-7667H	30309- 30311		Timestamp	YY/MM; DD/HH; Min/Sec			
7668H	30312	Eq_Imp	Max Demand	Rx/10	32768~32767	Int	R
7669H-766BH	30313- 30315		Timestamp	YY/MM; DD/HH; Min/Sec			
766CH	30316	Eq_Exp	Max Demand	Rx/10	32768~32767	Int	R
766DH-766FH	30317- 30319		Timestamp	YY/MM; DD/HH; Min/Sec			
7670H	30320	Es	Max Demand	Rx/10	32768~32767	Int	R
7671H-7673H	30321- 30323		Timestamp	YY/MM; DD/HH; Min/Sec			
7674H	30324	la	Max Demand	Rx*(CT1/ CT2)/1000	32768~32767	Int	R
7675H-7677H	30325- 30327		Timestamp	YY/MM; DD/HH; Min/Sec			

AccuVim II Series Power Meter

Previous Month Maximum Demand TOU Energy: 03H, 10H Write							
Address(H)	Address(D)	Symbol	Parameter	Relationship	Range	Data Type	Access Property
7678H	30328	lb	Max Demand	Rx*(CT1/ CT2)/1000	32768~32767	Int	R
7679H-767BH	30329- 30331		Timestamp	YY/MM; DD/HH; Min/Sec			
767CH	30332	lc	Max Demand	Rx*(CT1/ CT2)/1000	32768~32767	Int	R
767DH-767FH	30333- 30334		Timestamp	YY/MM; DD/HH; Min/Sec			
Total							
7680H	30336	Ep_Imp	Max Demand	Rx/10	32768~32767	Int	R
7681H-7683H	30337- 30339		Timestamp	YY/MM; DD/HH; Min/Sec			
7684H	30340	Ep_Exp	Max Demand	Rx/10	32768~32767	Int	R
7685H-7687H	30341- 30343		Timestamp	YY/MM; DD/HH; Min/Sec			
7688H	30344	Eq_Imp	Max Demand	Rx/10	32768~32767	Int	R
7689H-768BH	30345- 30347		Timestamp	YY/MM; DD/HH; Min/Sec			
768CH	30348	Eq_Exp	Max Demand	Rx/10	32768~32767	Int	R
768DH-768FH	30349- 30351		Timestamp	YY/MM; DD/HH; Min/Sec			
7690H	30352	Es	Max Demand	Rx/10	32768~32767	Int	R
7691H-7693H	30353- 30355		Timestamp	YY/MM; DD/HH; Min/Sec			
7694H	30356	la	Max Demand	Rx*(CT1/ CT2)/1000	32768~32767	Int	R
7695H-7697H	30357- 30359		Timestamp	YY/MM; DD/HH; Min/Sec			

Previous Month Maximum Demand TOU Energy: 03H, 10H Write							
Address(H)	Address(D)	Symbol	Parameter	Relationship	Range	Data Type	Access Property
7698H	30360	lb	Max Demand	Rx*(CT1/CT2)/1000	32768~32767	Int	R
7699H-769BH	30361-30363		Timestamp	YY/MM; DD/HH; Min/Sec			
769CH	30364	lc	Max Demand	Rx*(CT1/CT2)/1000	32768~32767	Int	R
769DH-769FH	30365-30366		Timestamp	YY/MM; DD/HH; Min/Sec			

6.3.10 Power Quality Parameters

THD, Harmonics, odd HD, Crest Factor, THFF, K factor, etc. are all stored here where the data type is "Word."

NOTE: Voltage parameters refer to line voltage when it is set to "2LL/3LL" and phase voltage for others.

THD Parameters

Table 6-27

Power Quality: 03H Read							
Address(H)	Address(D)	Parameter	Relationship	Property	Range	Data Type	Access Property
405AH	16474	THD_V1(V12)	THD=Rx/100	%	≥0	Word	R
405BH	16475	THD_V2(V31)	THD=Rx/100	%	≥0	Word	R
405CH	16476	THD_V3(V23)	THD=Rx/100	%	≥0	Word	R
405DH	16477	THD_avg	THD=Rx/100	%	≥0	Word	R
405EH	16478	THD_I1	THD=Rx/100	%	≥0	Word	R
405FH	16479	THD_I2	THD=Rx/100	%	≥0	Word	R
4060H	16480	THD_I3	THD=Rx/100	%	≥0	Word	R
4061H	16481	THD_lavg	THD=Rx/100	%	≥0	Word	R

Voltage V1 (V12) Harmonics

Table 6-28

Voltage Harmonics, Even & Odd Harmonics, Crest Factor: 03H Read							
Address(H)	Address(D)	Parameter	Relationship	Property	Range	Data Type	Access Property
4062H	16482	V1(V12) 2nd Harmonic	THD=Rx/100	%	≥0	Word	R
4063H	16483	V1(V12) 3rd Harmonic	THD=Rx/100	%	≥0	Word	R
4064H	16484	V1(V12) 4th Harmonic	THD=Rx/100	%	≥0	Word	R
4065H	16485	V1(V12) 5th Harmonic	THD=Rx/100	%	≥0	Word	R
4066H	16486	V1(V12) 6th Harmonic	THD=Rx/100	%	≥0	Word	R
4067H	16487	V1(V12) 7th Harmonic	THD=Rx/100	%	≥0	Word	R
4068H	16488	V1(V12) 8th Harmonic	THD=Rx/100	%	≥0	Word	R
4069H	16489	V1(V12) 9th Harmonic	THD=Rx/100	%	≥0	Word	R
406AH	16490	V1(V12) 10th Harmonic	THD=Rx/100	%	≥0	Word	R
406BH	16491	V1(V12) 11th Harmonic	THD=Rx/100	%	≥0	Word	R
406CH	16492	V1(V12) 12th Harmonic	THD=Rx/100	%	≥0	Word	R
406DH	16493	V1(V12) 13th Harmonic	THD=Rx/100	%	≥0	Word	R
406EH	16494	V1(V12) 14th Harmonic	THD=Rx/100	%	≥0	Word	R
406FH	16495	V1(V12) 15th Harmonic	THD=Rx/100	%	≥0	Word	R
4070H	16496	V1(V12) 16th Harmonic	THD=Rx/100	%	≥0	Word	R
4071H	16497	V1(V12) 17th Harmonic	THD=Rx/100	%	≥0	Word	R
4072H	16498	V1(V12) 18th Harmonic	THD=Rx/100	%	≥0	Word	R
4073H	16499	V1(V12) 19th Harmonic	THD=Rx/100	%	≥0	Word	R
4074H	16500	V1(V12) 20th Harmonic	THD=Rx/100	%	≥0	Word	R
4075H	16501	V1(V12) 21st Harmonic	THD=Rx/100	%	≥0	Word	R

Voltage Harmonics, Even & Odd Harmonics, Crest Factor: 03H Read							
Address(H)	Address(D)	Parameter	Relationship	Property	Range	Data Type	Access Property
4076H	16502	V1(V12) 22nd Harmonic	THD=Rx/100	%	≥0	Word	R
4077H	16503	V1(V12) 23rd Harmonic	THD=Rx/100	%	≥0	Word	R
4078H	16504	V1(V12) 24th Harmonic	THD=Rx/100	%	≥0	Word	R
4079H	16505	V1(V12) 25th Harmonic	THD=Rx/100	%	≥0	Word	R
407AH	16506	V1(V12) 26th Harmonic	THD=Rx/100	%	≥0	Word	R
407BH	16507	V1(V12) 27th Harmonic	THD=Rx/100	%	≥0	Word	R
407CH	16508	V1(V12) 28th Harmonic	THD=Rx/100	%	≥0	Word	R
407DH	16509	V1(V12) 29th Harmonic	THD=Rx/100	%	≥0	Word	R
407EH	16510	V1(V12) 30th Harmonic	THD=Rx/100	%	≥0	Word	R
407FH	16511	V1(V12) 31st Harmonic	THD=Rx/100	%	≥0	Word	R
4500H	17664	V1(V12) 32nd Harmonic	THD=Rx/100	%	≥0	Word	R
4501H	17665	V1(V12) 33rd Harmonic	THD=Rx/100	%	≥0	Word	R
4502H	17666	V1(V12) 34th Harmonic	THD=Rx/100	%	≥0	Word	R
4503H	17667	V1(V12) 35th Harmonic	THD=Rx/100	%	≥0	Word	R
4504H	17668	V1(V12) 36th Harmonic	THD=Rx/100	%	≥0	Word	R
4505H	17669	V1(V12) 37th Harmonic	THD=Rx/100	%	≥0	Word	R
4506H	17670	V1(V12) 38th Harmonic	THD=Rx/100	%	≥0	Word	R
4507H	17671	V1(V12) 39th Harmonic	THD=Rx/100	%	≥0	Word	R
4508H	17672	V1(V12) 40th Harmonic	THD=Rx/100	%	≥0	Word	R
4509H	17673	V1(V12) 41st Harmonic	THD=Rx/100	%	≥0	Word	R
450AH	17674	V1(V12) 42nd Harmonic	THD=Rx/100	%	≥0	Word	R
450BH	17675	V1(V12) 43rd Harmonic	THD=Rx/100	%	≥0	Word	R

Voltage Harmonics, Even & Odd Harmonics, Crest Factor: 03H Read							
Address(H)	Address(D)	Parameter	Relationship	Property	Range	Data Type	Access Property
450CH	17676	V1(V12) 44th Harmonic	THD=Rx/100	%	≥0	Word	R
450DH	17677	V1(V12) 45th Harmonic	THD=Rx/100	%	≥0	Word	R
450EH	17678	V1(V12) 46th Harmonic	THD=Rx/100	%	≥0	Word	R
450FH	17679	V1(V12) 47th Harmonic	THD=Rx/100	%	≥0	Word	R
4510H	17680	V1(V12) 48th Harmonic	THD=Rx/100	%	≥0	Word	R
4511H	17681	V1(V12) 49th Harmonic	THD=Rx/100	%	≥0	Word	R
4512H	17682	V1(V12) 50th Harmonic	THD=Rx/100	%	≥0	Word	R
4513H	17683	V1(V12) 51st Harmonic	THD=Rx/100	%	≥0	Word	R
4514H	17684	V1(V12) 52nd Harmonic	THD=Rx/100	%	≥0	Word	R
4515H	17685	V1(V12) 53rd Harmonic	THD=Rx/100	%	≥0	Word	R
4516H	17686	V1(V12) 54th Harmonic	THD=Rx/100	%	≥0	Word	R
4517H	17687	V1(V12) 55th Harmonic	THD=Rx/100	%	≥0	Word	R
4518H	17688	V1(V12) 56th Harmonic	THD=Rx/100	%	≥0	Word	R
4519H	17689	V1(V12) 57th Harmonic	THD=Rx/100	%	≥0	Word	R
451AH	17690	V1(V12) 58th Harmonic	THD=Rx/100	%	≥0	Word	R
451BH	17691	V1(V12) 59th Harmonic	THD=Rx/100	%	≥0	Word	R
451CH	17692	V1(V12) 60th Harmonic	THD=Rx/100	%	≥0	Word	R
451DH	17693	V1(V12) 61st Harmonic	THD=Rx/100	%	≥0	Word	R
451EH	17694	V1(V12) 62nd Harmonic	THD=Rx/100	%	≥0	Word	R
451FH	17695	V1(V12) 63rd Harmonic	THD=Rx/100	%	≥0	Word	R
4080H	16512	Odd THD_V1(V12)	THD=Rx/100	%	≥0	Word	R
4081H	16513	Even THD_V1(V12)	THD=Rx/100	%	≥0	Word	R

Voltage Harmonics, Even & Odd Harmonics, Crest Factor: 03H Read							
Address(H)	Address(D)	Parameter	Relationship	Property	Range	Data Type	Access Property
4082H	16514	Crest Factor V1(V12)	CF=Rx/100	%	0~65535	Word	R
4083H	16515	THFF_V1(V12)	THFF=Rx/100	%	≥0	Word	R

Voltage V2(V31) Harmonics

Table 6-29

Voltage Harmonics, Even & Odd Harmonics, Crest Factor: 03H Read							
Address(H)	Address(D)	Parameter	Relationship	Property	Range	Data Type	Access Property
4084H	16516	V2(V31) 2nd Harmonic	THD=Rx/100	%	≥0	Word	R
4085H	16517	V2(V31) 3rd Harmonic	THD=Rx/100	%	≥0	Word	R
4086H	16518	V2(V31) 4th Harmonic	THD=Rx/100	%	≥0	Word	R
4087H	16519	V2(V31) 5th Harmonic	THD=Rx/100	%	≥0	Word	R
4088H	16520	V2(V31) 6th Harmonic	THD=Rx/100	%	≥0	Word	R
4089H	16521	V2(V31) 7th Harmonic	THD=Rx/100	%	≥0	Word	R
408AH	16522	V2(V31) 8th Harmonic	THD=Rx/100	%	≥0	Word	R
408BH	16523	V2(V31) 9th Harmonic	THD=Rx/100	%	≥0	Word	R
408CH	16524	V2(V31) 10th Harmonic	THD=Rx/100	%	≥0	Word	R
408DH	16525	V2(V31) 11th Harmonic	THD=Rx/100	%	≥0	Word	R
408EH	16526	V2(V31) 12th Harmonic	THD=Rx/100	%	≥0	Word	R
408FH	16527	V2(V31) 13th Harmonic	THD=Rx/100	%	≥0	Word	R
4090H	16528	V2(V31) 14th Harmonic	THD=Rx/100	%	≥0	Word	R
4091H	16529	V2(V31) 15th Harmonic	THD=Rx/100	%	≥0	Word	R
4092H	16530	V2(V31) 16th Harmonic	THD=Rx/100	%	≥0	Word	R
4093H	16531	V2(V31) 17th Harmonic	THD=Rx/100	%	≥0	Word	R

Voltage Harmonics, Even & Odd Harmonics, Crest Factor: 03H Read							
Address(H)	Address(D)	Parameter	Relationship	Property	Range	Data Type	Access Property
4094H	16532	V2(V31) 18th Harmonic	THD=R _x /100	%	≥0	Word	R
4095H	16533	V2(V31) 19th Harmonic	THD=R _x /100	%	≥0	Word	R
4096H	16534	V2(V31) 20th Harmonic	THD=R _x /100	%	≥0	Word	R
4097H	16535	V2(V31) 21th Harmonic	THD=R _x /100	%	≥0	Word	R
4098H	16536	V2(V31) 22th Harmonic	THD=R _x /100	%	≥0	Word	R
4099H	16537	V2(V31) 23rd Harmonic	THD=R _x /100	%	≥0	Word	R
409AH	16538	V2(V31) 24th Harmonic	THD=R _x /100	%	≥0	Word	R
409BH	16539	V2(V31) 25th Harmonic	THD=R _x /100	%	≥0	Word	R
409CH	16540	V2(V31) 26th Harmonic	THD=R _x /100	%	≥0	Word	R
409DH	16541	V2(V31) 27th Harmonic	THD=R _x /100	%	≥0	Word	R
409EH	16542	V2(V31) 28th Harmonic	THD=R _x /100	%	≥0	Word	R
409FH	16543	V2(V31) 29th Harmonic	THD=R _x /100	%	≥0	Word	R
40A0H	16544	V2(V31) 30th Harmonic	THD=R _x /100	%	≥0	Word	R
40A1H	16545	V2(V31) 31st Harmonic	THD=R _x /100	%	≥0	Word	R
4520H	17696	V2(V31) 32nd Harmonic	THD=R _x /100	%	≥0	Word	R
4521H	17697	V2(V31) 33rd Harmonic	THD=R _x /100	%	≥0	Word	R
4522H	17698	V2(V31) 34th Harmonic	THD=R _x /100	%	≥0	Word	R
4523H	17699	V2(V31) 35th Harmonic	THD=R _x /100	%	≥0	Word	R
4524H	17700	V2(V31) 36th Harmonic	THD=R _x /100	%	≥0	Word	R
4525H	17701	V2(V31) 37th Harmonic	THD=R _x /100	%	≥0	Word	R
4526H	17702	V2(V31) 38th Harmonic	THD=R _x /100	%	≥0	Word	R
4527H	17703	V2(V31) 39th Harmonic	THD=R _x /100	%	≥0	Word	R

Voltage Harmonics, Even & Odd Harmonics, Crest Factor: 03H Read							
Address(H)	Address(D)	Parameter	Relationship	Property	Range	Data Type	Access Property
4528H	17704	V2(V31) 40th Harmonic	THD=Rx/100	%	≥0	Word	R
4529H	17705	V2(V31) 41st Harmonic	THD=Rx/100	%	≥0	Word	R
452AH	17706	V2(V31) 42nd Harmonic	THD=Rx/100	%	≥0	Word	R
452BH	17707	V2(V31) 43rd Harmonic	THD=Rx/100	%	≥0	Word	R
452CH	17708	V2(V31) 44th Harmonic	THD=Rx/100	%	≥0	Word	R
425DH	17709	V2(V31) 45th Harmonic	THD=Rx/100	%	≥0	Word	R
452EH	17710	V2(V31) 46th Harmonic	THD=Rx/100	%	≥0	Word	R
452FH	17711	V2(V31) 47th Harmonic	THD=Rx/100	%	≥0	Word	R
4530H	17712	V2(V31) 48th Harmonic	THD=Rx/100	%	≥0	Word	R
4531H	17713	V2(V31) 49th Harmonic	THD=Rx/100	%	≥0	Word	R
4532H	17714	V2(V31) 50th Harmonic	THD=Rx/100	%	≥0	Word	R
4533H	17715	V2(V31) 51st Harmonic	THD=Rx/100	%	≥0	Word	R
4534H	17716	V2(V31) 52nd Harmonic	THD=Rx/100	%	≥0	Word	R
4535H	17717	V2(V31) 53rd Harmonic	THD=Rx/100	%	≥0	Word	R
4536H	17718	V2(V31) 54th Harmonic	THD=Rx/100	%	≥0	Word	R
4537H	17719	V2(V31) 55th Harmonic	THD=Rx/100	%	≥0	Word	R
4538H	17720	V2(V31) 56th Harmonic	THD=Rx/100	%	≥0	Word	R
4539H	17721	V2(V31) 57th Harmonic	THD=Rx/100	%	≥0	Word	R
453AH	17722	V2(V31) 58th Harmonic	THD=Rx/100	%	≥0	Word	R
453BH	17723	V2(V31) 59th Harmonic	THD=Rx/100	%	≥0	Word	R
453CH	17724	V2(V31) 60th Harmonic	THD=Rx/100	%	≥0	Word	R
453DH	17725	V2(V31) 61st Harmonic	THD=Rx/100	%	≥0	Word	R

Voltage Harmonics, Even & Odd Harmonics, Crest Factor: 03H Read							
Address(H)	Address(D)	Parameter	Relationship	Property	Range	Data Type	Access Property
453EH	17726	V2(V31) 62nd Harmonic	THD=Rx/100	%	≥0	Word	R
453FH	17727	V2(V31) 63rd Harmonic	THD=Rx/100	%	≥0	Word	R
40A2H	16546	Odd THD_V2(V31)	THD=Rx/100	%	≥0	Word	R
40A3H	16547	Even THD_V2(V31)	THD=Rx/100	%	≥0	Word	R
40A4H	16548	Crest Factor V2(V31)	THD=Rx/100	%	≥0	Word	R
40A5H	16549	THFF_V2(V31)	THFF=Rx/100	%	≥0	Word	R

Voltage V3(V23) Harmonics

Table 6-30

Voltage Harmonics, Even & Odd Harmonics, Crest Factor: 03H							
Address(H)	Address(D)	Parameter	Relationship	Property	Range	Data Type	Access Property
40A6H	16550	V3(V23) 2nd Harmonic	THD=Rx/100	%	≥0	Word	R
40A7H	16551	V3(V23) 3rd Harmonic	THD= Rx/100	%	≥0	Word	R
40A8H	16552	V3(V23) 4th Harmonic	THD=Rx/100	%	≥0	Word	R
40A9H	16553	V3(V23) 5th Harmonic	THD=Rx/100	%	≥0	Word	R
40AAH	16554	V3(V23) 6th Harmonic	THD=Rx/100	%	≥0	Word	R
40ABH	16555	V3(V23) 7th Harmonic	THD=Rx/100	%	≥0	Word	R
40ACH	16556	V3(V23) 8th Harmonic	THD=Rx/100	%	≥0	Word	R
40ADH	16557	V3(V23) 9th Harmonic	THD=Rx/100	%	≥0	Word	R
40AEH	16558	V3(V23) 10th Harmonic	THD=Rx/100	%	≥0	Word	R
40AFH	16559	V3(V23) 11th Harmonic	THD=Rx/100	%	≥0	Word	R
40B0H	16560	V3(V23) 12th Harmonic	THD=Rx/100	%	≥0	Word	R
40B1H	16561	V3(V23) 13th Harmonic	THD=Rx/100	%	≥0	Word	R
40B2H	16562	V3(V23) 14th Harmonic	THD=Rx/100	%	≥0	Word	R

Voltage Harmonics, Even & Odd Harmonics, Crest Factor: 03H							
Address(H)	Address(D)	Parameter	Relationship	Property	Range	Data Type	Access Property
40B3H	16563	V3(V23) 15th Harmonic	THD=R _x /100	%	≥0	Word	R
40B4H	16564	V3(V23) 16th Harmonic	THD=R _x /100	%	≥0	Word	R
40B5H	16565	V3(V23) 17th Harmonic	THD=R _x /100	%	≥0	Word	R
40B6H	16566	V3(V23) 18th Harmonic	THD=R _x /100	%	≥0	Word	R
40B7H	16567	V3(V23) 19th Harmonic	THD=R _x /100	%	≥0	Word	R
40B8H	16568	V3(V23) 20th Harmonic	THD=R _x /100	%	≥0	Word	R
40B9H	16569	V3(V23) 21st Harmonic	THD=R _x /100	%	≥0	Word	R
40BAH	16570	V3(V23) 22nd Harmonic	THD=R _x /100	%	≥0	Word	R
40BBH	16571	V3(V23) 23rd Harmonic	THD=R _x /100	%	≥0	Word	R
40BCH	16572	V3(V23) 24th Harmonic	THD=R _x /100	%	≥0	Word	R
40BDH	16573	V3(V23) 25th Harmonic	THD=R _x /100	%	≥0	Word	R
40BEH	16574	V3(V23) 26th Harmonic	THD=R _x /100	%	≥0	Word	R
40BFH	16575	V3(V23) 27th Harmonic	THD=R _x /100	%	≥0	Word	R
40C0H	16576	V3(V23) 28th Harmonic	THD=R _x /100	%	≥0	Word	R
40C1H	16577	V3(V23) 29th Harmonic	THD=R _x /100	%	≥0	Word	R
40C2H	16578	V3(V23) 30th Harmonic	THD=R _x /100	%	≥0	Word	R
40C3H	16579	V3(V23) 31st Harmonic	THD=R _x /100	%	≥0	Word	R
4540H	17728	V3(V23) 32nd Harmonic	THD=R _x /100	%	≥0	Word	R
4541H	17729	V3(V23) 33rd Harmonic	THD=R _x /100	%	≥0	Word	R
4542H	17730	V3(V23) 34th Harmonic	THD=R _x /100	%	≥0	Word	R
4543H	17731	V3(V23) 35th Harmonic	THD=R _x /100	%	≥0	Word	R
4544H	17732	V3(V23) 36th Harmonic	THD=R _x /100	%	≥0	Word	R

Voltage Harmonics, Even & Odd Harmonics, Crest Factor: 03H							
Address(H)	Address(D)	Parameter	Relationship	Property	Range	Data Type	Access Property
4545H	17733	V3(V23) 37th Harmonic	THD=R _x /100	%	≥0	Word	R
4546H	17734	V3(V23) 38th Harmonic	THD=R _x /100	%	≥0	Word	R
4547H	17735	V3(V23) 39th Harmonic	THD=R _x /100	%	≥0	Word	R
4548H	17736	V3(V23) 40th Harmonic	THD=R _x /100	%	≥0	Word	R
4549H	17737	V3(V23) 41st Harmonic	THD=R _x /100	%	≥0	Word	R
454AH	17738	V3(V23) 42nd Harmonic	THD=R _x /100	%	≥0	Word	R
454BH	17739	V3(V23) 43rd Harmonic	THD=R _x /100	%	≥0	Word	R
454CH	17740	V3(V23) 44th Harmonic	THD=R _x /100	%	≥0	Word	R
454DH	17741	V3(V23) 45th Harmonic	THD=R _x /100	%	≥0	Word	R
454EH	17742	V3(V23) 46th Harmonic	THD=R _x /100	%	≥0	Word	R
454FH	17743	V3(V23) 47th Harmonic	THD=R _x /100	%	≥0	Word	R
4550H	17744	V3(V23) 48th Harmonic	THD=R _x /100	%	≥0	Word	R
4551H	17745	V3(V23) 49th Harmonic	THD=R _x /100	%	≥0	Word	R
4552H	17746	V3(V23) 50th Harmonic	THD=R _x /100	%	≥0	Word	R
4553H	17747	V3(V23) 51st Harmonic	THD=R _x /100	%	≥0	Word	R
4554H	17748	V3(V23) 52nd Harmonic	THD=R _x /100	%	≥0	Word	R
4555H	17749	V3(V23) 53rd Harmonic	THD=R _x /100	%	≥0	Word	R
4556H	17750	V3(V23) 54th Harmonic	THD=R _x /100	%	≥0	Word	R
4557H	17751	V3(V23) 55th Harmonic	THD=R _x /100	%	≥0	Word	R
4558H	17752	V3(V23) 56th Harmonic	THD=R _x /100	%	≥0	Word	R
4559H	17753	V3(V23) 57th Harmonic	THD=R _x /100	%	≥0	Word	R
455AH	17754	V3(V23) 58th Harmonic	THD=R _x /100	%	≥0	Word	R

Voltage Harmonics, Even & Odd Harmonics, Crest Factor: 03H							
Address(H)	Address(D)	Parameter	Relationship	Property	Range	Data Type	Access Property
455BH	17755	V3(V23) 59th Harmonic	THD=Rx/100	%	≥0	Word	R
455CH	17756	V3(V23) 60th Harmonic	THD=Rx/100	%	≥0	Word	R
455DH	17757	V3(V23) 61st Harmonic	THD=Rx/100	%	≥0	Word	R
455EH	17758	V3(V23) 62nd Harmonic	THD=Rx/100	%	≥0	Word	R
455FH	17759	V3(V23) 63rd Harmonic	THD=Rx/100	%	≥0	Word	R
40C4H	16580	Odd THD_V3(V23)	THD=Rx/100	%	≥0	Word	R
40C5H	16581	Even THD_V3(V23)	THD=Rx/100	%	≥0	Word	R
40C6H	16582	Crest Factor V3(V23)	CF=Rx/100	%	0~65535	Word	R
40C7H	16583	THDD_V3(V23)	THFF=Rx/100	%	≥0	Word	R

I1 Current Harmonics

Table 6-31

Current Harmonics, Even & Odd Harmonics, K Factor: 03H Read							
Address(H)	Address(D)	Parameter	Relationship	Property	Range	Data Type	Access Property
40C8H	16584	I1 2nd Harmonic	THD=Rx/100	%	≥0	Word	R
40C9H	16585	I1 3rd Harmonic	THD=Rx/100	%	≥0	Word	R
40CAH	16586	I1 4th Harmonic	THD=Rx/100	%	≥0	Word	R
40CBH	16587	I1 5th Harmonic	THD=Rx/100	%	≥0	Word	R
40CCH	16588	I1 6th Harmonic	THD=Rx/100	%	≥0	Word	R
40CDH	16589	I1 7th Harmonic	THD=Rx/100	%	≥0	Word	R
40CEH	16590	I1 8th Harmonic	THD=Rx/100	%	≥0	Word	R
40CFH	16591	I1 9th Harmonic	THD=Rx/100	%	≥0	Word	R
40D0H	16592	I1 10th Harmonic	THD=Rx/100	%	≥0	Word	R
40D1H	16593	I1 11th Harmonic	THD=Rx/100	%	≥0	Word	R
40D2H	16594	I1 12th Harmonic	THD=Rx/100	%	≥0	Word	R
40D3H	16595	I1 13th Harmonic	THD=Rx/100	%	≥0	Word	R
40D4H	16596	I1 14th Harmonic	THD=Rx/100	%	≥0	Word	R

Current Harmonics, Even & Odd Harmonics, K Factor: 03H Read							
Address(H)	Address(D)	Parameter	Relationship	Property	Range	Data Type	Access Property
40D5H	16597	I1 15th Harmonic	THD=Rx/100	%	≥0	Word	R
40D6H	16598	I1 16th Harmonic	THD=Rx/100	%	≥0	Word	R
40D7H	16599	I1 17th Harmonic	THD=Rx/100	%	≥0	Word	R
40D8H	16600	I1 18th Harmonic	THD=Rx/100	%	≥0	Word	R
40D9H	16601	I1 19th Harmonic	THD=Rx/100	%	≥0	Word	R
40DAH	16602	I1 20th Harmonic	THD=Rx/100	%	≥0	Word	R
40DBH	16603	I1 21st Harmonic	THD=Rx/100	%	≥0	Word	R
40DCH	16604	I1 22nd Harmonic	THD=Rx/100	%	≥0	Word	R
40DDH	16605	I1 23rd Harmonic	THD=Rx/100	%	≥0	Word	R
40DEH	16606	I1 24th Harmonic	THD=Rx/100	%	≥0	Word	R
40DFH	16607	I1 25th Harmonic	THD=Rx/100	%	≥0	Word	R
40E0H	16608	I1 26th Harmonic	THD=Rx/100	%	≥0	Word	R
40E1H	16609	I1 27th Harmonic	THD=Rx/100	%	≥0	Word	R
40E2H	16610	I1 28th Harmonic	THD=Rx/100	%	≥0	Word	R
40E3H	16611	I1 29th Harmonic	THD=Rx/100	%	≥0	Word	R
40E4H	16612	I1 30th Harmonic	THD=Rx/100	%	≥0	Word	R
40E5H	16613	I1 31st Harmonic	THD=Rx/100	%	≥0	Word	R
4560H	17760	I1 32nd Harmonic	THD=Rx/100	%	≥0	Word	R
4561H	17762	I1 33rd Harmonic	THD=Rx/100	%	≥0	Word	R
4562H	17763	I1 34th Harmonic	THD=Rx/100	%	≥0	Word	R
4563H	17764	I1 35th Harmonic	THD=Rx/100	%	≥0	Word	R
4564H	17765	I1 36th Harmonic	THD=Rx/100	%	≥0	Word	R
4565H	17765	I1 37th Harmonic	THD=Rx/100	%	≥0	Word	R
4566H	17766	I1 38th Harmonic	THD=Rx/100	%	≥0	Word	R
4567H	17767	I1 39th Harmonic	THD=Rx/100	%	≥0	Word	R
4568H	17768	I1 40th Harmonic	THD=Rx/100	%	≥0	Word	R
4569H	17769	I1 41st Harmonic	THD=Rx/100	%	≥0	Word	R
456AH	17770	I1 42nd Harmonic	THD=Rx/100	%	≥0	Word	R
456BH	17771	I1 43rd Harmonic	THD=Rx/100	%	≥0	Word	R
456CH	17772	I1 44th Harmonic	THD=Rx/100	%	≥0	Word	R

Current Harmonics, Even & Odd Harmonics, K Factor: 03H Read							
Address(H)	Address(D)	Parameter	Relationship	Property	Range	Data Type	Access Property
456DH	17773	I1 45th Harmonic	THD=Rx/100	%	≥0	Word	R
456EH	17774	I1 46th Harmonic	THD=Rx/100	%	≥0	Word	R
456FH	17775	I1 47th Harmonic	THD=Rx/100	%	≥0	Word	R
4570H	17776	I1 48th Harmonic	THD=Rx/100	%	≥0	Word	R
4571H	17777	I1 49th Harmonic	THD=Rx/100	%	≥0	Word	R
4572H	17778	I1 50th Harmonic	THD=Rx/100	%	≥0	Word	R
4573H	17779	I1 51st Harmonic	THD=Rx/100	%	≥0	Word	R
4574H	17780	I1 52nd Harmonic	THD=Rx/100	%	≥0	Word	R
4575H	17781	I1 53rd Harmonic	THD=Rx/100	%	≥0	Word	R
4576H	17782	I1 54th Harmonic	THD=Rx/100	%	≥0	Word	R
4577H	17783	I1 55th Harmonic	THD=Rx/100	%	≥0	Word	R
4578H	17784	I1 56th Harmonic	THD=Rx/100	%	≥0	Word	R
4579H	17785	I1 57th Harmonic	THD=Rx/100	%	≥0	Word	R
457AH	17786	I1 58th Harmonic	THD=Rx/100	%	≥0	Word	R
457BH	17787	I1 59th Harmonic	THD=Rx/100	%	≥0	Word	R
457CH	17788	I1 60th Harmonic	THD=Rx/100	%	≥0	Word	R
457DH	17789	I1 61st Harmonic	THD=Rx/100	%	≥0	Word	R
457EH	17790	I1 62nd Harmonic	THD=Rx/100	%	≥0	Word	R
457FH	17791	I1 63rd Harmonic	THD=Rx/100	%	≥0	Word	R
40E6H	16614	Odd THD_I1	THD=Rx/100	%	≥0	Word	R
40E7H	16615	Even_THD_I1	THD=Rx/100	%	≥0	Word	R
40E8H	16616	K Factor of I1	CF=Rx/100	%	≥0	Word	R

I2 Current Harmonics

Table 6-32

Current Harmonics, Even & Odd Harmonics, K Factor: 03H Read							
Address(H)	Address(D)	Parameter	Relationship	Property	Range	Data Type	Access Property
40E9H	16617	I2 2nd Harmonic	THD=Rx/100	%	≥0	Word	R
40EAH	16618	I2 3rd Harmonic	THD=Rx/100	%	≥0	Word	R

Current Harmonics, Even & Odd Harmonics, K Factor: 03H Read							
Address(H)	Address(D)	Parameter	Relationship	Property	Range	Data Type	Access Property
40EBH	16619	I2 4th Harmonic	THD=Rx/100	%	≥0	Word	R
40ECH	16620	I2 5th Harmonic	THD=Rx/100	%	≥0	Word	R
40EDH	16621	I2 6th Harmonic	THD=Rx/100	%	≥0	Word	R
40EEH	16622	I2 7th Harmonic	THD=Rx/100	%	≥0	Word	R
40EFH	16623	I2 8th Harmonic	THD=Rx/100	%	≥0	Word	R
40F0H	16624	I2 9th Harmonic	THD=Rx/100	%	≥0	Word	R
40F1H	16625	I2 10th Harmonic	THD=Rx/100	%	≥0	Word	R
40F2H	16626	I2 11th Harmonic	THD=Rx/100	%	≥0	Word	R
40F3H	16627	I2 12th Harmonic	THD=Rx/100	%	≥0	Word	R
40F4H	16628	I2 13th Harmonic	THD=Rx/100	%	≥0	Word	R
40F5H	16629	I2 14th Harmonic	THD=Rx/100	%	≥0	Word	R
40F6H	16630	I2 15th Harmonic	THD=Rx/100	%	≥0	Word	R
40F7H	16631	I2 16th Harmonic	THD=Rx/100	%	≥0	Word	R
40F8H	16632	I2 17th Harmonic	THD=Rx/100	%	≥0	Word	R
40F9H	16633	I2 18th Harmonic	THD=Rx/100	%	≥0	Word	R
40FAH	16634	I2 19th Harmonic	THD=Rx/100	%	≥0	Word	R
40FBH	16635	I2 20th Harmonic	THD=Rx/100	%	≥0	Word	R
40FCH	16636	I2 21st Harmonic	THD=Rx/100	%	≥0	Word	R
40FDH	16637	I2 22nd Harmonic	THD=Rx/100	%	≥0	Word	R
40FEH	16638	I2 23rd Harmonic	THD=Rx/100	%	≥0	Word	R
40FFH	16639	I2 24th Harmonic	THD=Rx/100	%	≥0	Word	R
4100H	16640	I2 25th Harmonic	THD=Rx/100	%	≥0	Word	R
4101H	16641	I2 26th Harmonic	THD=Rx/100	%	≥0	Word	R
4102H	16642	I2 27th Harmonic	THD=Rx/100	%	≥0	Word	R
4103H	16643	I2 28th Harmonic	THD=Rx/100	%	≥0	Word	R
4104H	16644	I2 29th Harmonic	THD=Rx/100	%	≥0	Word	R
4105H	16645	I2 30th Harmonic	THD=Rx/100	%	≥0	Word	R
4106H	16646	I2 31st Harmonic	THD=Rx/100	%	≥0	Word	R
4580H	17792	I2 32nd Harmonic	THD=Rx/100	%	≥0	Word	R
4581H	17793	I2 33rd Harmonic	THD=Rx/100	%	≥0	Word	R

Current Harmonics, Even & Odd Harmonics, K Factor: 03H Read							
Address(H)	Address(D)	Parameter	Relationship	Property	Range	Data Type	Access Property
4582H	17794	I2 34th Harmonic	THD=Rx/100	%	≥0	Word	R
4583H	17795	I2 35th Harmonic	THD=Rx/100	%	≥0	Word	R
4584H	17796	I2 36th Harmonic	THD=Rx/100	%	≥0	Word	R
4585H	17797	I2 37th Harmonic	THD=Rx/100	%	≥0	Word	R
4586H	17798	I2 38th Harmonic	THD=Rx/100	%	≥0	Word	R
4587H	17799	I2 39th Harmonic	THD=Rx/100	%	≥0	Word	R
4588H	17800	I2 40th Harmonic	THD=Rx/100	%	≥0	Word	R
4589H	17801	I2 41st Harmonic	THD=Rx/100	%	≥0	Word	R
458AH	17802	I2 42nd Harmonic	THD=Rx/100	%	≥0	Word	R
458BH	17803	I2 43rd Harmonic	THD=Rx/100	%	≥0	Word	R
458CH	17804	I2 44th Harmonic	THD=Rx/100	%	≥0	Word	R
458DH	17805	I2 45th Harmonic	THD=Rx/100	%	≥0	Word	R
458EH	17806	I2 46th Harmonic	THD=Rx/100	%	≥0	Word	R
458FH	17807	I2 47th Harmonic	THD=Rx/100	%	≥0	Word	R
4590H	17808	I2 48th Harmonic	THD=Rx/100	%	≥0	Word	R
4591H	17809	I2 49th Harmonic	THD=Rx/100	%	≥0	Word	R
4592H	17810	I2 50th Harmonic	THD=Rx/100	%	≥0	Word	R
4593H	17811	I2 51st Harmonic	THD=Rx/100	%	≥0	Word	R
4594H	17812	I2 52nd Harmonic	THD=Rx/100	%	≥0	Word	R
4595H	17813	I2 53rd Harmonic	THD=Rx/100	%	≥0	Word	R
4596H	17814	I2 54th Harmonic	THD=Rx/100	%	≥0	Word	R
4597H	17815	I2 55th Harmonic	THD=Rx/100	%	≥0	Word	R
4598H	17816	I2 56th Harmonic	THD=Rx/100	%	≥0	Word	R
4599H	17817	I2 57th Harmonic	THD=Rx/100	%	≥0	Word	R
459AH	17818	I2 58th Harmonic	THD=Rx/100	%	≥0	Word	R
459BH	17819	I2 59th Harmonic	THD=Rx/100	%	≥0	Word	R
459CH	17820	I2 60th Harmonic	THD=Rx/100	%	≥0	Word	R
459DH	17821	I2 61st Harmonic	THD=Rx/100	%	≥0	Word	R
459EH	17822	I2 62nd Harmonic	THD=Rx/100	%	≥0	Word	R
459FH	17823	I2 63rd Harmonic	THD=Rx/100	%	≥0	Word	R

Current Harmonics, Even & Odd Harmonics, K Factor: 03H Read							
Address(H)	Address(D)	Parameter	Relationship	Property	Range	Data Type	Access Property
4107H	16647	Odd THD_I2	THD=Rx/100	%	≥0	Word	R
4108H	16648	Even THD_I2	THD=Rx/100	%	≥0	Word	R
4109H	16649	K Factor of I2	CF=Rx/100	%	≥0	Word	R

I3 Current Harmonics

Table 6-33

Current Harmonics, Even & Odd Harmonics, K Factor: 03H Read							
Address(H)	Address(D)	Parameter	Relationship	Property	Range	Data Type	Access Property
410AH	16650	I3 2nd Harmonic	THD=Rx/100	%	≥0	Word	R
410BH	16551	I3 3rd Harmonic	THD=Rx/100	%	≥0	Word	R
410CH	16652	I3 4th Harmonic	THD=Rx/100	%	≥0	Word	R
410DH	16553	I3 5th Harmonic	THD=Rx/100	%	≥0	Word	R
410EH	16554	I3 6th Harmonic	THD=Rx/100	%	≥0	Word	R
410FH	16555	I3 7th Harmonic	THD=Rx/100	%	≥0	Word	R
4110H	16556	I3 8th Harmonic	THD=Rx/100	%	≥0	Word	R
4111H	16657	I3 9th Harmonic	THD=Rx/100	%	≥0	Word	R
4112H	16558	I3 10th Harmonic	THD=Rx/100	%	≥0	Word	R
4113H	16559	I3 11th Harmonic	THD=Rx/100	%	≥0	Word	R
4114H	16660	I3 12th Harmonic	THD=Rx/100	%	≥0	Word	R
4115H	16661	I3 13th Harmonic	THD=Rx/100	%	≥0	Word	R
4116H	16662	I3 14th Harmonic	THD=Rx/100	%	≥0	Word	R
4117H	16663	I3 15th Harmonic	THD=Rx/100	%	≥0	Word	R
4118H	16664	I3 16th Harmonic	THD=Rx/100	%	≥0	Word	R
4119H	16665	I3 17th Harmonic	THD=Rx/100	%	≥0	Word	R
411AH	16666	I3 18th Harmonic	THD=Rx/100	%	≥0	Word	R
411BH	16667	I3 19th Harmonic	THD=Rx/100	%	≥0	Word	R
411CH	16668	I3 20th Harmonic	THD=Rx/100	%	≥0	Word	R
411DH	16669	I3 21st Harmonic	THD=Rx/100	%	≥0	Word	R
411EH	16670	I3 22nd Harmonic	THD=Rx/100	%	≥0	Word	R

Current Harmonics, Even & Odd Harmonics, K Factor: 03H Read							
Address(H)	Address(D)	Parameter	Relationship	Property	Range	Data Type	Access Property
411FH	16671	I3 23rd Harmonic	THD=Rx/100	%	≥0	Word	R
4120H	16672	I3 24th Harmonic	THD=Rx/100	%	≥0	Word	R
4121H	16673	I3 25th Harmonic	THD=Rx/100	%	≥0	Word	R
4122H	16674	I3 26th Harmonic	THD=Rx/100	%	≥0	Word	R
4123H	16675	I3 27th Harmonic	THD=Rx/100	%	≥0	Word	R
4124H	16676	I3 28th Harmonic	THD=Rx/100	%	≥0	Word	R
4125H	16677	I3 29th Harmonic	THD=Rx/100	%	≥0	Word	R
4126H	16678	I3 30th Harmonic	THD=Rx/100	%	≥0	Word	R
4127H	16679	I3 31st Harmonic	THD=Rx/100	%	≥0	Word	R
45A0H	17824	I3 32nd Harmonic	THD=Rx/100	%	≥0	Word	R
45A1H	17825	I3 33rd Harmonic	THD=Rx/100	%	≥0	Word	R
45A2H	17826	I3 34th Harmonic	THD=Rx/100	%	≥0	Word	R
45A3H	17827	I3 35th Harmonic	THD=Rx/100	%	≥0	Word	R
45A4H	17828	I3 36th Harmonic	THD=Rx/100	%	≥0	Word	R
45A5H	17829	I3 37th Harmonic	THD=Rx/100	%	≥0	Word	R
45A6H	17830	I3 38th Harmonic	THD=Rx/100	%	≥0	Word	R
45A7H	17831	I3 39th Harmonic	THD=Rx/100	%	≥0	Word	R
45A8H	17832	I3 40th Harmonic	THD=Rx/100	%	≥0	Word	R
45A9H	17833	I3 41st Harmonic	THD=Rx/100	%	≥0	Word	R
45AAH	17834	I3 42nd Harmonic	THD=Rx/100	%	≥0	Word	R
45ABH	17835	I3 43rd Harmonic	THD=Rx/100	%	≥0	Word	R
45ACH	17836	I3 44th Harmonic	THD=Rx/100	%	≥0	Word	R
45ADH	17837	I3 45th Harmonic	THD=Rx/100	%	≥0	Word	R
45AEH	17838	I3 46th Harmonic	THD=Rx/100	%	≥0	Word	R
45AFH	17839	I3 47th Harmonic	THD=Rx/100	%	≥0	Word	R
45B0H	17840	I3 48th Harmonic	THD=Rx/100	%	≥0	Word	R
45B1H	17841	I3 49th Harmonic	THD=Rx/100	%	≥0	Word	R
45B2H	17842	I3 50th Harmonic	THD=Rx/100	%	≥0	Word	R
45B3H	17843	I3 51st Harmonic	THD=Rx/100	%	≥0	Word	R
45B4H	17844	I3 52nd Harmonic	THD=Rx/100	%	≥0	Word	R

Current Harmonics, Even & Odd Harmonics, K Factor: 03H Read							
Address(H)	Address(D)	Parameter	Relationship	Property	Range	Data Type	Access Property
45B5H	17845	I3 53rd Harmonic	THD=Rx/100	%	≥0	Word	R
45B6H	17846	I3 54th Harmonic	THD=Rx/100	%	≥0	Word	R
45B7H	17847	I3 55th Harmonic	THD=Rx/100	%	≥0	Word	R
45B8H	17848	I3 56th Harmonic	THD=Rx/100	%	≥0	Word	R
45B9H	17849	I3 57th Harmonic	THD=Rx/100	%	≥0	Word	R
45BAH	17850	I3 58th Harmonic	THD=Rx/100	%	≥0	Word	R
45BBH	17851	I3 59th Harmonic	THD=Rx/100	%	≥0	Word	R
45BCH	17852	I3 60th Harmonic	THD=Rx/100	%	≥0	Word	R
45BDH	17853	I3 61st Harmonic	THD=Rx/100	%	≥0	Word	R
45BEH	17854	I3 62nd Harmonic	THD=Rx/100	%	≥0	Word	R
45BFH	17855	I3 63rd Harmonic	THD=Rx/100	%	≥0	Word	R
4128H	16680	Odd THD_I3	THD=Rx/100	%	≥0	Word	R
4129H	16681	Even THD_I3	THD=Rx/100	%	≥0	Word	R
412AH	16682	K Factor of I3	CF=Rx/100	%	≥0	Word	R

NOTE: When selecting 400Hz type, harmonics support 2nd~15th.

6.3.11 Max & Min Values

Records MAX/MIN value and timestamp.

Maximum Values

Table 6-34

MAX: 03H Read							
Address(H)	Address(D)	Parameter	Relationship	Property	Range	Data Type	Access Property
4136H	16694	Max of V1	$(Rx*(PT1/PT2))/10$	V	32768~32767	int	R
4137H-413CH	16695-16700	Timestamp	YYYY:MM:DD:hh:mm:ss			int	R
413DH	16701	Max of V2	$(Rx*(PT1/PT2))/10$	V	32768~32767	int	R
413EH-4143H	16702-16707	Timestamp	YYYY:MM:DD:hh:mm:ss			int	R
4144H	16708	Max of V3	$(Rx*(PT1/PT2))/10$	V	32768~32767	int	R

MAX: 03H Read							
Address(H)	Address(D)	Parameter	Relationship	Property	Range	Data Type	Access Property
4145H-414AH	16709-16714	Timestamp	YYYY:MM:DD:hh:mm:ss			int	R
414BH	16715	Max of V12	$(Rx*(PT1/PT2))/10$	V	32768~32767	int	R
414CH-4151H	16716-16721	Timestamp	YYYY:MM:DD:hh:mm:ss			int	R
4152H	16722	Max of V23	$(Rx*(PT1/PT2))/10$	V	32768~32767	int	R
4153H-4158H	16723-16728	Timestamp	YYYY:MM:DD:hh:mm:ss			int	R
4159H	16729	Max of V31	$(Rx*(PT1/PT2))/10$	V	32768~32767	int	R
415AH-415FH	16730-16735	Timestamp	YYYY:MM:DD:hh:mm:ss			int	R
4160H	16736	Max of I1	$(Rx*(CT1/CT2))/1000$	A	32768~32767	int	R
4161H-4166H	16737-16742	Timestamp	YYYY:MM:DD:hh:mm:ss			int	R
4167H	16743	Max of I2	$(Rx*(CT1/CT2))/1000$	A	32768~32767	int	R
4168H-416DH	16744-16749	Timestamp	YYYY:MM:DD:hh:mm:ss			int	R
416EH	16750	Max of I3	$(Rx*(CT1/CT2))/1000$	A	32768~32767	int	R
416FH-4174H	16751-16756	Timestamp	YYYY:MM:DD:hh:mm:ss			int	R
4175H	16757	Max of System Power	$(Rx*(CT1/CT2)*(PT1/PT2))/1000$	kW	32768~32767	int	R
4176H-417BH	16758-16763	Timestamp	YYYY:MM:DD:hh:mm:ss			int	R
417CH	16764	Max of Reactive Power	$(Rx*(CT1/CT2)*(PT1/PT2))/1000$	kvar	32768~32767	int	R
417DH-4182H	16765-16770	Timestamp	YYYY:MM:DD:hh:mm:ss			int	R
4183H	16771	Max of Apparent Power	$(Rx*(CT1/CT2)*(PT1/PT2))/1000$	kVA	32768~32767	int	R
4184H-4189H	16772-16777	Timestamp	YYYY:MM:DD:hh:mm:ss			int	R
418AH	16778	Max of Power Factor	Rx/1000		32768~32767	int	R
418BH-4190H	16779-16784	Timestamp	YYYY:MM:DD:hh:mm:ss			int	R

AccuVim II Series Power Meter

MAX: 03H Read							
Address(H)	Address(D)	Parameter	Relationship	Property	Range	Data Type	Access Property
4191H	16785	Max of Frequency	Rx/1000	Hz	32768~32767	int	R
4192H-4197H	16786-16791	Timestamp	YYYY:MM:DD:hh:mm:ss			int	R
4198H	16792	Max of Power Demand	$(Rx*(CT1/CT2)*(PT1/PT2))/1000$	kW	32768~32767	int	R
4199H-419EH	16793-16798	Timestamp	YYYY:MM:DD:hh:mm:ss			int	R
419FH	16799	Max of Reactive Power Demand	$(Rx*(CT1/CT2)*(PT1/PT2))/1000$	kvar	32768~32767	int	R
41A0H-41A5H	16800-16805	Timestamp	YYYY:MM:DD:hh:mm:ss			int	R
41A6H	16806	Max of Apparent Power Demand	$(Rx*(CT1/CT2)*(PT1/PT2))/1000$	kVA	32768~32767	int	R
41A7H-41ACH	16807-16812	Timestamp	YYYY:MM:DD:hh:mm:ss			int	R
4606H	17926	Max of Phase A Current Demand	$(Rx*(CT1/CT2))/1000$	A	32768~32767	int	R
4607H-460CH	17927-17932	Timestamp	YYYY:MM:DD:hh:mm:ss			int	R
460DH	17933	Max of Phase B Current Demand	$(Rx*(CT1/CT2))/1000$	A	32768~32767	int	R
460EH-4613H	17934-17939	Timestamp	YYYY:MM:DD:hh:mm:ss			int	R
4614H	17940	Max of Phase C Current Demand	$(Rx*(CT1/CT2))/1000$	A	32768~32767	int	R
4615H-461AH	17941-17946	Timestamp	YYYY:MM:DD:hh:mm:ss			int	R
41ADH	16813	Max of Voltage Unbalance	Rx/10	%	32768~32767	int	R
41AEH-41B3H	16814-16819	Timestamp	YYYY:MM:DD:hh:mm:ss			int	R
41B4H	16820	Max of Current Unbalance	Rx/10	%	32768~32767	int	R
41B5H-41BAH	16821-16826	Timestamp	YYYY:MM:DD:hh:mm:ss			int	R
41BBH	16827	Max of THD_V1(V12)		%	32768~32767	int	R
41BCH-41C1H	16828-16833	Timestamp	YYYY:MM:DD:hh:mm:ss			int	R

MAX: 03H Read							
Address(H)	Address(D)	Parameter	Relationship	Property	Range	Data Type	Access Property
41C2H	16834	Max of THD_V2(V31)	Rx/100	%	32768~32767	int	R
41C3H-41C8H	16835-16840	Timestamp	YYYY:MM:DD:hh:mm:ss			int	R
41C9H	16841	Max of THD_V3(V23)	Rx/100	%	32768~32767	int	R
41CAH-41CFH	16842-16847	Timestamp	YYYY:MM:DD:hh:mm:ss			int	R
41D0H	16848	Max of THD_I1	Rx/100	%	32768~32767	int	R
41D1H-41D6H	16849-16854	Timestamp	YYYY:MM:DD:hh:mm:ss			int	R
41D7H	16855	Max of THD_I2	Rx/100	%	32768~32767	int	R
41D8H-41DDH	16856-16861	Timestamp	YYYY:MM:DD:hh:mm:ss			int	R
41DEH	16862	Max of THD_I3	Rx/100	%	32768~32767	int	R
41DFH-41E4H	16863-16868	Timestamp	YYYY:MM:DD:hh:mm:ss			int	R

Minimum Values

Table 6-35

MIN: 03H Read							
Address(H)	Address(D)	Parameter	Relationship	Property	Range	Data Type	Access Property
41E5H	16869	Min of V1	$(Rx*(PT1/PT2))/10$	V	32768~32767	int	R
41E6H-41EBH	16870-16875	Timestamp	YYYY:MM:DD:hh:mm:ss			int	R
41ECH	16876	Min of V2	$(Rx*(PT1/PT2))/10$	V	32768~32767	int	R
41EDH-41F2H	16877-16882	Timestamp	YYYY:MM:DD:hh:mm:ss			int	R
41F3H	16883	Min of V3	$(Rx*(PT1/PT2))/10$	V	32768~32767	int	R
41F4H-41F9H	16884-16889	Timestamp	YYYY:MM:DD:hh:mm:ss			int	R
41FAH	16890	Min of V12	$(Rx*(PT1/PT2))/10$	V	32768~32767	int	R
41FBH-4200H	16891-16896	Timestamp	YYYY:MM:DD:hh:mm:ss			int	R

AccuVim II Series Power Meter

MIN: 03H Read							
Address(H)	Address(D)	Parameter	Relationship	Property	Range	Data Type	Access Property
4201H	16897	Min of V23	$(Rx*(PT1/PT2))/10$	V	32768~32767	int	R
4202H-4207H	16898-16903	Timestamp	YYYY:MM:DD:hh:mm:ss			int	R
4208H	16904	Min of V31	$(Rx*(PT1/PT2))/10$	V	32768~32767	int	R
4209H-420EH	16905-16910	Timestamp	YYYY:MM:DD:hh:mm:ss			int	R
420FH	16911	Min of I1	$(Rx*(CT1/CT2))/1000$	A	32768~32767	int	R
4210H-4215H	16912-16917	Timestamp	YYYY:MM:DD:hh:mm:ss			int	R
4216H	16918	Min of I2	$(Rx*(CT1/CT2))/1000$	A	32768~32767	int	R
4217H-421CH	16919-16924	Timestamp	YYYY:MM:DD:hh:mm:ss			int	R
421DH	16925	Min of I3	$(Rx*(CT1/CT2))/1000$	A	32768~32767	int	R
421EH-4223H	16926-16931	Timestamp	YYYY:MM:DD:hh:mm:ss			int	R
4224H	16932	Min of System Power	$(Rx*(CT1/CT2)*(PT1/PT2))/1000$	kW	32768~32767	int	R
4225H-422AH	16933-16938	Timestamp	YYYY:MM:DD:hh:mm:ss			int	R
422BH	16939	Min of Reactive Power	$(Rx*(CT1/CT2)*(PT1/PT2))/1000$	kvar	32768~32767	int	R
422CH-4231H	16940-16945	Timestamp	YYYY:MM:DD:hh:mm:ss			int	R
4232H	16946	Max of Apparent Power	$(Rx*(CT1/CT2)*(PT1/PT2))/1000$	kVA	32768~32767	int	R
4233H-4238H	16947-16952	Timestamp	YYYY:MM:DD:hh:mm:ss			int	R
4239H	16953	Min of Power Factor	$Rx/1000$		32768~32767	int	R
423AH-423FH	16954-16959	Timestamp	YYYY:MM:DD:hh:mm:ss			int	R
4240H	16960	Max of Frequency	$Rx/1000$	Hz	32768~32767	int	R
4241H-4246H	16961-16966	Timestamp	YYYY:MM:DD:hh:mm:ss			int	R
4247H	16967	Min of Power Demand	$(Rx*(CT1/CT2)*(PT1/PT2))/1000$	kW	32768~32767	int	R

MIN: 03H Read							
Address(H)	Address(D)	Parameter	Relationship	Property	Range	Data Type	Access Property
4248H-424DH	16968-16973	Timestamp	YYYY:MM:DD:hh:mm:ss			int	R
424EH	16974	Max of Reactive Power Demand	$(Rx*(CT1/CT2)*(PT1/PT2))/1000$	kvar	32768~32767	int	R
424FH-4254H	16975-16980	Timestamp	YYYY:MM:DD:hh:mm:ss			int	R
4255H	16981	Max of Apparent Power Demand	$(Rx*(CT1/CT2)*(PT1/PT2))/1000$	kVA	32768~32767	int	R
4256H-425BH	16982-16987	Timestamp	YYYY:MM:DD:hh:mm:ss			int	R
425CH	16988	Min of Voltage Unbalance	Rx/10	%	32768~32767	int	R
425DH-4262H	16989-16994	Timestamp	YYYY:MM:DD:hh:mm:ss			int	R
4263H	16995	Min of Current Unbalance	Rx/10	%	32768~32767	int	R
4264H-4269H	16996-17001	Timestamp	YYYY:MM:DD:hh:mm:ss			int	R
426AH	17002	Min of THD_V1 (V12)	Rx/100	%	32768~32767	int	R
426BH-4270H	17003-17008	Timestamp	YYYY:MM:DD:hh:mm:ss			int	R
4271H	17009	Min of THD_V2 (V31)	Rx/100	%	32768~32767	int	R
4272H-4277H	17010-17015	Timestamp	YYYY:MM:DD:hh:mm:ss			int	R
4278H	17016	Min of THD_V3(V23)	Rx/100	%	32768~32767	int	R
4279H-427EH	17017-17022	Timestamp	YYYY:MM:DD:hh:mm:ss			int	R
427FH	17023	Min of THD_I1	Rx/100	%	32768~32767	int	R
4280H-4285H	17024-17029	Timestamp	YYYY:MM:DD:hh:mm:ss			int	R
4286H	17030	Min of THD_I2	Rx/100	%	32768~32767	int	R
4287H-428CH	17031-17036	Timestamp	YYYY:MM:DD:hh:mm:ss			int	R
428DH	17037	Min of THD_I3	Rx/100	%	32768~32767	int	R
428EH-4293H	17038-17043	Timestamp	YYYY:MM:DD:hh:mm:ss			int	R

NOTE: The MAX and MIN frequency value should use word data type (0~65535).

6.3.12 Phase Angles

All voltage and current phase angles corresponding to V1 (V120) are stored here. You can find out the phase sequence according to them. Data type is "Word".

Table 6-36

Phase Angles: 03H Read						
Address(H)	Address(D)	Parameter	Relationship	Range	Data Type	Access Property
42A0H	17056	Phase Angle of V2 to V1	V2=Rx/10	0~3600	Word	R
42A1H	17057	Phase Angle of V3 to V1	V3=Rx/10	0~3600	Word	R
42A2H	17058	Phase Angle of I1 to V1	I1=Rx/10	0~3600	Word	R
42A3H	17059	Phase Angle of I2 to V1	I2=Rx/10	0~3600	Word	R
42A4H	17060	Phase Angle of I3 to V1	I3=Rx/10	0~3600	Word	R

6.3.13 Sequence Component

U1 (U12), I1 consist of a real part and complex part. They have positive sequence, negative sequence, and zero sequence. Data type is "Int."

Table 6-37

Sequence Component: 03H Read							
Address(H)	Address(D)	Parameter	Relationship	Property	Range	Data Type	Access Property
4294H	17044	Positive Sequence real part of V1	THD=Rx/100	%	-32768~32768	Word	R
4295H	17045	Positive Sequence complex part of V1	THD=Rx/100	%	-32768~32768	Word	R
4296H	17046	Negative Sequence real part of V1	THD=Rx/100	%	-32768~32768	Word	R
4297H	17047	Negative Sequence complex part of V1	THD=Rx/100	%	-32768~32768	Word	R
4298H	17048	Zero Sequence real part of V1	THD=Rx/100	%	-32768~32768	Word	R
4299H	17049	Zero Sequence complex part of V1	THD=Rx/100	%	-32768~32768	Word	R
429AH	17050	Positive Sequence real part of I1	THD=Rx/100	%	-32768~32768	Word	R
429BH	17051	Positive Sequence complex part of I1	THD=Rx/100	%	-32768~32768	Word	R
429CH	17052	Negative Sequence real part of I1	THD=Rx/100	%	-32768~32768	Word	R

Sequence Component: 03H Read							
Address(H)	Address(D)	Parameter	Relationship	Property	Range	Data Type	Access Property
429DH	17053	Negative Sequence complex part of I1	THD=Rx/100	%	-32768~32768	Word	R
429EH	17054	Zero Sequence real part of I1	THD=Rx/100	%	-32768~32768	Word	R
29FH	17055	Zero Sequence complex part of I1	THD=Rx/100	%	-32768~32768	Word	R

6.3.14 I/O Module Settings

I/O module setting changes will be made only if the corresponding I/O modules are installed, otherwise no changes will be made. Please check the I/O module connection status before doing any settings. Function code: 03H for reading, 10H for writing. Please refer to Chapter 5 Extended Modules for details.

AXM-IO11

Table 6-38

AXM-IO1-1 Settings: 03H Read, 10H Write					
Address	Parameters	Default	Range	Data Type	Property
109EH	DI1~6 type	0	Bit0: DI1, Bit1: DI2, Bit2: DI3, Bit3: DI4 Bit4: DI5, Bit5: DI6, 0: DI, 1: Pulse counter	Word	R/W
109FH	DI pulse constant	0	1~65535	Word	R/W
10A0H	Working mode of relay 1 and 2	0	0: Control output, 1: Alarming output	Word	R/W
10A1H	Output mode of relay 1 and 2	0	0: Latch, 1: Pulse	Word	R/W
10A2H	Pulse width	50	50~3000ms	Word	R/W

AXM-IO21

Table 6-39

AXM-IO2-1 Settings, 10H Write					
Address	Parameters	Default	Range	Data Type	Property
10A3H	DI11~14 type	0	Bit0: DI7, Bit1: DI8, Bit2: DI9, Bit3: DI10 0: DI, 1: Pulse counter	Word	R/W
10A4H	DI pulse constant	0	1~65535	Word	R/W

AXM-IO2-1 Settings, 10H Write					
Address	Parameters	Default	Range	Data Type	Property
10A5H	Working mode of relay 3 and 4	0	0: Pulse output, 1: Alarming output	Word	R/W
10A6H	Output mode of relay 3 and 4	0	20~1000ms	Word	R/W
10A7H	Pulse width	50	0: None, 1: Consumption power 2: Generating power 3: Absorption reactive power 4: Generating reactive power	Word	R/W
10A8H	AI1, 2 type	1 or 2	0: None, 1: Consumption power 2: Generating power 3: Absorption reactive power 4: Generating reactive power	Word	R/W
10A9H	Pulse width	50	0: 0~20mA, 1: 4~20mA, 2: 0~5V, 3: 1~5V	Word	R/W

AXM-IO31

Table 6-40

AXM-IO3-1 Settings: 03H Read, 10H Write					
Address	Parameters	Default	Range	Data Type	Property
10AAH	DI11~14 type	0	Bit0: DI11, Bit1: DI12, Bit2: DI13, Bit3: DI14 0: DI, 1: Pulse counter	Word	R/W
10ABH	DI pulse constant	0	1~65535	Word	R/W
10ACH	Working mode of relay 3 and 4	0	0: Control output, 1: Alarming output	Word	R/W
10ADH	Output mode of relay 3 and 4	0	0: Latch, 1: Pulse	Word	R/W
10AEH	Pulse width	50	50~3000ms	Word	R/W
10AFH	AI1, 2 type	1 or 2	0: 0~20mA, 1: 4~20mA, 2: 0~5V, 3: 1~5V	Word	R/W

AXM-IO12

Table 6-41

AXM-IO1-2 Settings: 03H Read, 10H Write					
Address	Parameters	Default	Range	Data Type	Property
10B0H	DI15~20 type	0	Bit0: DI15, Bit1: DI16	Word	R/W
10B1H	DI pulse constant (high)	0	1~65535	Word	R/W
10B2H	Working mode of relay 5 and 6	0	0: Control output, 1: Alarming output	Word	R/W
10B3H	Output mode of relay 5 and 6	0	0: Latch, 1: Pulse	Word	R/W
10B4H	Pulse width	50	50~3000ms	Word	R/W

AXM-IO22

Table 6-42

AXM-IO2-2 Settings: 03H Read, 10H Write					
Address	Parameters	Default	Range	Data Type	Property
10B5H	DI21~24 type	0	Bit0: DI21, Bit1: DI22, Bit2: DI23, Bit3: DI24, 0: DI, 1: Pulse counter	Word	R/W
10B6H	DI pulse constant	0	1~65535	Word	R/W
10B7H	Working mode of DO3, 4	0	0: Pulse output, 1: Alarming output	Word	R/W
10B8H	DO pulse width	20	20~1000ms	Word	R/W
10B9H	DO3 output	0	0: None, 1: Consumption power 2: Generating power 3: Absorption reactive power 4: Generating reactive power	Word	R/W
10BAH	DO4 output	0	0: None, 1: Consumption power 2: Generating power 3: Absorption reactive power 4: Generating reactive power	Word	R/W
10BBH	AO3, 4 type	1 or 2	0: 0~20mA, 1: 4~20mA, 2: 0~5V, 3: 1~5V	Word	R/W

AXM-IO32

Table 6-43

AXM-IO3-2 Settings: 03H Read, 10H Write					
Address	Parameters	Default	Range	Data Type	Property
10BCH	DI25~28 type	0	Bit0: DI25, Bit1: DI26, Bit2: DI27, Bit3: DI28 0: DI, 1: Pulse constant	Word	R/W
10BDH	DI pulse constant	0	1~65535	Word	R/W
10BEH	Working mode of relay 7 and 8	0	0: Control output, 1: Alarming output	Word	R/W
10BFH	Output mode of relay 7 and 8	0	0: Latch, 1: Pulse	Word	R/W
10C0H	Pulse width	50	50~3000	Word	R/W
10C1H	AI3, 4 type	1 or 2	0: 0~20mA, 1: 4~20mA, 2: 0~5V, 3: 1~5V	Word	R/W

AO Parameter Selection

Table 6-44

AO Parameter Selection: 03H Read, 10H Write					
Address	Parameters	Default	Range	Data Type	Property
10C2H	AO1 parameter	0	Refer to the table 6-45 below	Word	R/W
10C3H	AO2 parameter	0	Refer to the table 6-45 below	Word	R/W
10C4H	AO3 parameter	0	Refer to the table 6-45 below	Word	R/W
10C5H	AO4 parameter	0	Refer to the table 6-45 below	Word	R/W

AO Parameter Translation Table

Table 6-45

AO Parameter Selection					
Setting Value	Transforming Object	Setting Value	Transforming Object	Setting Value	Transforming Object
0	Frequency	1	Va	2	Vb
3	Vc	4	Average phase voltage	5	Uab
6	Ubc	7	Uca	8	Average line voltage
9	Current of phase A	10	Current of phase B	11	Current of phase C
12	Average current	13	Neutral current	14	Power of phase A

AO Parameter Selection					
Setting Value	Transforming Object	Setting Value	Transforming Object	Setting Value	Transforming Object
15	Power of phase B	16	Power of phase C	17	Power of all
18	Reactive power of A	19	Reactive power of phase B	20	Reactive power of phase C
21	Reactive power of all	22	Apparent power of phase A	23	Apparent power of phase B
24	Apparent power of phase C	25	Apparent power of all	26	PF of A
27	PF of B	28	PF of C	29	PF

AO Range Configuration

Table 6-46

AO Parameter Selection: 03H Read, 10H Write					
Address	Parameters	Default	Range	Data Type	Property
10D0H	AO1 Gradient Number selection of input/output transfer curve	1	1: 1 Gradient 2: 2 Gradient 3: 3 Gradient	INT	R/W
10D1H	AO1 following value range setting start point		Please see note	INT	R/W
10D2H	AO1 following value range setting point 2			INT	R/W
10D3H	AO1 following value range setting point 3			INT	R/W
10D4H	AO1 following value range setting end point			INT	R/W
10D5H	AO1 output range setting start point		AO type of 0~24A or 0~6: 0~4915 AO type of 4~24A or 1~6: 819~4915	INT	R/W
10D6H	AO1 output range setting point 2			INT	R/W
10D7H	AO1 output range setting point 3			INT	R/W
10D8H	AO1 output range setting end point			INT	R/W
109H-10E1H	AO2 Gradient Setting (same as AO1)		Same as AO1	INT	R/W
10E2H-10EAH	AO3 Gradient Setting (same as AO1)		Same as AO1	INT	R/W
10EBH-10F3H	AO4 Gradient Setting (same as AO1)		Same as AO1	INT	R/W

NOTE:

1. AO Gradient Number Selection of input/output transfer curve

When the number is 1, only the AO following value range setting start point, AO following value range setting end point, AO1 output range setting start point, and AO1 output range setting endpoint should be set.

When number is 2, only the AO following value range setting start point, AO1 following value range setting point 2, AO following value range setting end point, AO1 output range setting start point, AO1 output range setting point 2, and AO1 output range setting endpoint should be set.

When number is 3, only the AO following value range setting start point, AO1 following value range setting point 2, AO1 following value range setting point 3, and AO following value range setting end point should be set. At the same time, the AO1 output range setting start point, AO1 output range setting point 2, AO1 output range setting point 3, and AO1 output range setting end point should be set.

Following value range setting:

The AO following value range setting start point, AO1 following value range setting point 2, AO1 following value range setting point 3, and AO following value range setting end point are increasing value, while they should be within range of the AO following value. Otherwise, the function of the AO will be affected.

Frequency: When selecting 50Hz or 60Hz type, the frequency range is 45Hz ~ 65Hz and the real setting value is 4500 ~ 6500. When selecting 400Hz type, the frequency range is 300Hz ~ 500Hz and the real setting value is 30000~50000.

Phase voltage V1, V2, V3 and average phase voltage: 0~480V, real setting value is 0~4800.

Line voltage V12, V23, V31 and average line voltage: 0~831V, real setting value is 0~8310.

Current I1, I2, I3 and average current: 0~10A, real setting value is 0~10000.

Power Pa, Pb and Pc: -4800~4800W, real setting value is -4800~4800.

System power: -14400~14400W, real setting value is -14400~14400.

Reactive power Qa, Qb and Qc: -4800~4800 Var, real setting value is -4800~4800.

System reactive power: -14400~14400 Var.

Apparent power Sa, Sb and Sc: 0~4800VA, real setting value is 0~4800.

System apparent power: 0~14400VA, real setting value is 0~14400.

Power factor PFa, PFb, PFC and System power factor: -1~1, real setting value is -1000~1000.

AO output range setting:

The AO output value range setting start point, AO1 output value range setting point 2, AO1 output value range setting point 3, and AO output value range setting end point are increasing value, while they should be within range of the AO output value.

When the AO type is 0~20mA, the setting value range is 0~ 4915, and the relationship is $\text{mA} = \text{setting value} * 20 / 4096$.

When the AO type is 4~20mA, the setting value range is 819~ 4915, and the relationship is $\text{mA} = \text{setting value} * 20 / 4096$.

When the AO type is 0~5V, the setting value range is 0~ 4915, and the relationship is $V = \text{setting value} * 5 / 4096$.

When the AO type is 1~5V, the setting value range is 819~ 4915, and the relationship is $V = \text{setting value} * 5 / 4096$.

Counting Pulses on DI

DI are arranged according to expanded I/O module addresses, user can check on the counting number of DI along with those modules. The DI counting record are stored in a non-volatile memory and will not be erased during power off. They can be reset via communication and panel. Data type is "Dword".

6.3.15 I/O Module Readings Settings**DI Counter**

Table 6-47

DI Counter: 03H Read						
Address(H)	Address(D)	Symbol	Parameter	Range	Data Type	Access Property
AXM-IO1-1						
4349H-434AH	17225-17226	DI_111	DI1 Pulse Counter Number	0~4294967295	Dword	R
434BH-434CH	17227-17228	DI_112	DI2 Pulse Counter Number	0~4294967295	Dword	R
434DH-434EH	17229-17230	DI_113	DI3 Pulse Counter Number	0~4294967295	Dword	R
434FH-4350H	17231-17232	DI_114	DI4 Pulse Counter number	0~4294967295	Dword	R
4351H-4352H	17233-17234	DI_115	DI5 Pulse Counter Number	0~4294967295	Dword	R

DI Counter: 03H Read						
Address(H)	Address(D)	Symbol	Parameter	Range	Data Type	Access Property
4353H-4354H	17235-17236	DI_116	DI6 Pulse Counter Number	0~4294967295	Dword	R
AXM-IO2-1						
4355H-4356H	17237-17238	DI_211	DI7 Pulse Counter Number	0~4294967295	Dword	R
4357H-4358H	17239-17240	DI_212	DI8 Pulse Counter Number	0~4294967295	Dword	R
4359H-435AH	17241-17242	DI_213	DI9 Pulse Counter Number	0~4294967295	Dword	R
435BH-435CH	17243-17244	DI_214	DI10 Pulse Counter Number	0~4294967295	Dword	R
AXM-IO3-1						
435DH-435EH	17245-17246	DI_311	DI11 Pulse Counter Number	0~4294967295	Dword	R
435FH-4360H	17247-17248	DI_312	DI12 Pulse Counter Number	0~4294967295	Dword	R
4361H-4362H	17249-17250	DI_313	DI13 Pulse Counter Number	0~4294967295	Dword	R
4363H-4364H	17251-17252	DI_314	DI14 Pulse Counter Number	0~4294967295	Dword	R
AXM-IO1-2						
4365H-4366H	17253-17254	DI_121	DI15 Pulse Counter Number	0~4294967295	Dword	R
4367H-4368H	17255-17256	DI_122	DI16 Pulse Counter Number	0~4294967295	Dword	R
4369H-436AH	17257-17258	DI_123	DI17 Pulse Counter Number	0~4294967295	Dword	R
436BH-436CH	17259-17260	DI_124	DI18 Pulse Counter Number	0~4294967295	Dword	R
436DH-436EH	17261-17262	DI_125	DI19 Pulse Counter Number	0~4294967295	Dword	R
436FH-4370H	17263-17264	DI_126	DI20 Pulse Counter Number	0~4294967295	Dword	R
AXM-IO2-2						
4371H-4372H	17265-17266	DI_221	DI21 Pulse Counter Number	0~4294967295	Dword	R
4373H-4374H	17267-17268	DI_222	DI22 Pulse Counter Number	0~4294967295	Dword	R
4375H-4376H	17269-17270	DI_223	DI23 Pulse Counter Number	0~4294967295	Dword	R
4377H-4378H	17271-17272	DI_224	DI24 Pulse Counter Number	0~4294967295	Dword	R

DI Counter: 03H Read						
Address(H)	Address(D)	Symbol	Parameter	Range	Data Type	Access Property
AXM-IO3-2						
4371H-4372H	17265-17266	DI_221	DI21 Pulse Counter Number	0~4294967295	Dword	R
4373H-4374H	17267-17268	DI_222	DI22 Pulse Counter Number	0~4294967295	Dword	R
4375H-4376H	17269-17270	DI_223	DI23 Pulse Counter Number	0~4294967295	Dword	R
4377H-4378H	17271-17272	DI_224	DI24 Pulse Counter Number	0~4294967295	Dword	R

DI Status

Table 6-48

DI Status: 02H Read						
Address(H)	Address(D)	Symbol	Parameter	Range	Data Type	Access Property
AXM-IO1-1						
0000H	0	DI_111	DI1 Status	0: OFF 1: ON	Bit	R
0001H	1	DI_112	DI2 Status	0: OFF 1: ON	Bit	R
0002H	2	DI_113	DI3 Status	0: OFF 1: ON	Bit	R
0003H	3	DI_114	DI4 Status	0: OFF 1: ON	Bit	R
0004H	4	DI_115	DI5 Status	0: OFF 1: ON	Bit	R
0005H	5	DI_116	DI6 Status	0: OFF 1: ON	Bit	R
AXM-IO2-1						
0006H	6	DI_211	DI7 Status	0: OFF 1: ON	Bit	R
0007H	7	DI_212	DI8 Status	0: OFF 1: ON	Bit	R
0008H	8	DI_213	DI9 Status	0: OFF 1: ON	Bit	R
0009H	9	DI_214	DI10 Status	0: OFF 1: ON	Bit	R

DI Status: 02H Read						
Address(H)	Address(D)	Symbol	Parameter	Range	Data Type	Access Property
AXM-IO3-1						
000AH	10	DI_311	DI11 Status	0: OFF 1: ON	Bit	R
000BH	11	DI_312	DI12 Status	0: OFF 1: ON	Bit	R
000CH	12	DI_313	DI13 Status	0: OFF 1: ON	Bit	R
000DH	13	DI_314	DI14 Status	0: OFF 1: ON	Bit	R
AXM-IO1-2						
000EH	14	DI_121	DI15 Status	0: OFF 1: ON	Bit	R
000FH	15	DI_122	DI16 Status	0: OFF 1: ON	Bit	R
0010H	16	DI_123	DI17 Status	0: OFF 1: ON	Bit	R
0011H	17	DI_124	DI18 Status	0: OFF 1: ON	Bit	R
0012H	18	DI_125	DI19 Status	0: OFF 1: ON	Bit	R
0013H	19	DI_126	DI20 Status	0: OFF 1: ON	Bit	R
AXM-IO2-2						
0014H	20	DI_221	DI21 Status	0: OFF 1: ON	Bit	R
0015H	21	DI_222	DI22 Status	0: OFF 1: ON	Bit	R
0016H	22	DI_223	DI23 Status	0: OFF 1: ON	Bit	R
0017H	23	DI_224	DI24 Status	0: OFF 1: ON	Bit	R
AXM-IO3-2						
0018H	24	DI_321	DI25 Status	0: OFF 1: ON	Bit	R
0019H	25	DI_322	DI26 Status	0: OFF 1: ON	Bit	R

DI Status: 02H Read						
Address(H)	Address(D)	Symbol	Parameter	Range	Data Type	Access Property
001AH	26	DI_323	DI27 Status	0: OFF 1: ON	Bit	R
001BH	27	DI_324	DI28 Status	0: OFF 1: ON	Bit	R

Analog Input

The output of AI is mapped to the range of 0~4095 according to its sampling value using an algorithm. Data type is "Word".

Table 6-49

AI Input Value: 03H Read						
Address(H)	Address(D)	Symbol	Parameters	Range	Data Type	Access Property
4385H	17285	AI_311	AI1 Sampling value	0~4095	Dword	R
4386H	17286	AI_312	AI2 Sampling value	0~4095	Dword	R
4387H	17287	AI_321	AI3 Sampling value	0~4095	Dword	R
4388H	17288	AI_322	AI4 Sampling value	0~4095	Dword	R

Analog Output

The output of the AO is the actual value of output. There are 2 output options for AO: V or mA. Over/under limit or data type is "Float".

Table 6-50

AO Output Value: 03H Read						
Address(H)	Address(D)	Symbol	Parameters	Range	Data Type	Access Property
4389H-438AH	17289-17290	AO_211	Value of AO1		Float	R
438BH-438CH	17291-17292	AO_212	Value of AO2		Float	R
438DH-438EH	17293-17294	AO_221	Value of AO3		Float	R
438FH-4390H	17295-17296	AO_222	Value of AO4		Float	R

Relay Output

Table 6-51

DI Status: 02H Read						
Address(H)	Address(D)	Symbol	Parameters	Range	Data Type	Access Property
AXM-101-1						
0000H	0	RO_111	RO1	0:OFF 1:ON	Bit	R
0001H	1	RO_112	RO2	0:OFF 1:ON	Bit	R
AXM-IO3-1						
0002H	2	RO_311	RO3	0: OFF 1: ON	Bit	R
0003H	3	RO_312	RO4	0: OFF 1: ON	Bit	R
AXM-IO1-2						
0004H	4	RO_121	RO5	0: OFF 1: ON	Bit	R
0005H	5	RO_122	RO6	0: OFF 1: ON	Bit	R
AXM-IO3-2						
0006H	6	RO_321	RO7	0: OFF 1: ON	Bit	R
0007H	7	RO_322	RO8	0: OFF 1: ON	Bit	R

SOE Records

There are 20 groups of records with the same format. Before gathering SOE records, the selected I/O module must be SOE enabled. If the SOE enabled I/O module is not connected, SOE record logs will not be collected.

Table 6-52

Address	Parameters	Code	Range	Data Type	Property
4339H~439FH	First group: timestamp: yyy:mm:dd:hh:mm:ms	F3		Word	R
43A0H	First group: DI status	F1		Word	R
43A1H~4438H	2nd to 20th group			Word	R

Address	Parameters	Code	Range	Data Type	Property
4439H	Value of A04	F1	0: None 1: AXM-IO11 2: AXM-IO21 3: AXM-IO31 4: AXM-IO12 5: AXM-IO22 6: AXM-IO32	Word	R

6.3.16 SunSpec Registers

Table 6-53

SunSpec: 03H Read, 10H Write							
Address(H)	Address(D)	Parameters	Range	Default	Data Type	Access Property	Number of Registers
C350H-C351H	50000-50001	SunSpec_ID	0x53756e53			R	2
C352H	50002	ID	1		Uint16	R	1
C353H	50003	Length	65		String	R	1
C354H-C363H	50004-50019	Manufacturer		Accuenergy	String	R	16
C364H-C373H	50020-50035	Model	Manufacturer Specific Value (32 characters)	Acuvim II	String	R	16
C374H-C37BH	50036-50043	Options	Manufacturer Specific Value (16 characters)	Acuvim IIR/IIW	String	R	8
C37CH-C383H	50044-50051	Version	Manufacturer Specific Value (16 characters)	H: 2.31 S: 3.60	String	R	8
C384H-C393H	50052-50067	Serial Numsber	Manufacturer Specific Value (32 characters)		String	R	16
C394H	50068	Device Address	Modbus Device Address		Uint16	R	1

Acuvim II Series Power Meter

SunSpec: 03H Read, 10H Write							
Address(H)	Address(D)	Parameters	Range	Default	Data Type	Access Property	Number of Registers
C395H	50069	ID	Meter Configuration: Single Phase (AN or AB): 201 Split Single Phase (ABN): 202 WYE-Three Phase (ABCN): 203 Delta Three Phase (ABC): 204		Uint16	R	1
C396H	50070	Length	81		Uint16	R	1
C397H	50071	Current: Amps(Average)	0~32767 A		Int16	R	1
C398H	50072	Current: Phase A	0~32767 A		Int16	R	1
C399H	50073	Current: Phase B	0~32767 A		Int16	R	1
C39AH	50074	Current: Phase C	0~32767 A		Int16	R	1
C39BH	50075	Current SunSpec Scale Factor	0~32767 A		sunssf	R	1
C39CH	50076	Voltage: Average Phase	3~2 (used an exponent of a power of 10)		int16	R	1
C39DH	50077	Voltage: Phase A	0~9999 V		int16	R	1
C39EH	50078	Voltage: Phase B	0~9999 V		int16	R	1
C39FH	50079	Voltage: Phase C	0~9999 V		int16	R	1
C3A0H	50080	Voltage: Line-Line Average	0~9999 V		int16	R	1
C3A1H	50081	Voltage: Line AB	0~9999 V		int16	R	1
C3A2H	50082	Voltage: Line BC	0~9999V		int16	R	1
C3A3H	50083	Voltage: Line CA	0~9999 V		int16	R	1
C3A4H	50084	Voltage Scale Factor	2~4(used as an exponent of a power of 10)		sunssf	R	1
C3A5H	50085	Frequency	45-65Hz		int16	R	1

SunSpec: 03H Read, 10H Write							
Address(H)	Address(D)	Parameters	Range	Default	Data Type	Access Property	Number of Registers
C3A6H	50086	Frequency Scale Factor	2(used as an exponent of a power of 10)		sunssf	R	1
C3A7H	50087	Total Real Power	32768~32767 W		int16	R	1
C3A8H	50088	Real Power: Phase A Watts	32768~32767 W		int16	R	1
C3A9H	50089	Real Power: Phase B Watts	32768~32767 W		int16	R	1
C3AAH	50090	Real Power: Phase C Watts	32768~32767		int16	R	1
C3ABH	50091	Real Power Scale Factor	1~8(used as an exponent of a power of 10)		sunssf	R	1
C3ACH	50092	Total Apparent Power	0~32367 VA		int16	R	1
C3ADH	50093	Apparent Power: Phase A VA	0~32367 VA		int16	R	1
C3AEH	50094	Apparent Power: Phase B VA	0~32367 VA		int16	R	1
C3AFH	50095	Apparent Power: Phase C VA	0~32767 VA		int16	R	1
C3B0H	50096	Apparent Power Scale Factor	1~8(used as an exponent of a power of 10)		sunssf	R	1
C3B1H	50097	Total Reactive Power	32768~32767 var		int16	R	1
C3B2H	50098	Reactive Power: Phase A var	32768~32767 var		int16	R	1
C3B3H	50099	Reactive Power: Phase B var	3278~32767 var		int16	R	1
C3B4H	50100	Reactive Power: Phase C var	32768~32767 var		int16	R	1
C3B5H	50101	Reactive Power Scale Factor	1~8(used as an exponent of a power of 10)		sunssf	R	1
C3B6H	50102	Power Factor	1000~1000		int16	R	1
C3B7H	50103	Power Factor: Phase A PF	1000~1000		int16	R	1
C3B8H	50104	Power Factor: Phase B PF	1000~1000		int16	R	1
C3B9H	50105	Power Factor: Phase C PF	1000~1000		int16	R	1

AccuVim II Series Power Meter

SunSpec: 03H Read, 10H Write							
Address(H)	Address(D)	Parameters	Range	Default	Data Type	Access Property	Number of Registers
C3BAH	50106	Power Factor Scale Factor	3(used an exponent of a power of 10)		sunssf	R	1
C3BBH-C3BCH	50107-50108	Total Real Energy: Export	0-999999999 Wh		int32	R/W	2
C3BDH-C3BEH	50109-50110	Export Real Energy: Phase A	0-999999999 Wh		int32	R/W	2
C3BFH-C3C0H	50111-50112	Export Real Energy: Phase B	0-999999999 Wh		int32	R/W	2
C3C1H-C3C2H	50113-50114	Export Real Energy: Phase C	0-999999999 Wh		int32	R/W	2
C3C3H-C3C4H	50115-50116	Total Real Energy: Import	0-999999999 Wh		int32	R/W	2
C3C5H-C3C6H	50117-50118	Import Real Energy: Phase A	0-999999999 Wh		int32	R/W	2
C3C7H-C3C8H	50119-50120	Import Real Energy: Phase B	0-999999999 Wh		int32	R/W	2
C3C9H-C3CAH	50121-50122	Import Real Energy: Phase C	0-999999999 Wh		int32	R/W	2
C3CBH	50123	Real Energy Scale Factor	0,2(used as an exponent of a power of 10)		sunssf	R	1
C3CCH-C3CDH	50124-50125	Total Apparent Energy	0-999999999 VAh		int32	R/W	2
C3CEH-C3CFH	50126-50127	Apparent Energy: Phase A	0-999999999 VAh		int32	R/W	2
C3D0H-C3D1H	50128-50129	Apparent Energy: Phase B	0-999999999 VAh		int32	R/W	2
C3D2H-C3D3H	50130-50131	Apparent Energy: Phase C	0-999999999 VAh		int32	R/W	2
C3D4H	50132	Apparent Energy Scale Factor	0,2(used as an exponent of a power of 10)		sunssf	R	1
C3D5H-C3D6H	50133-50134	Total Reactive Energy: Export	0-999999999 varh		int32	R/W	2
C3D7H-C3D8H	50135-50136	Export Reactive Energy: Phase A	0-999999999 varh		int32	R/W	2
C3D9H-C3DAH	50137-50138	Export Reactive Energy: Phase B	0-999999999 varh		int32	R/W	2
C3DBH-C3DCH	50139-50140	Export Reactive Energy: Phase C	0-999999999 varh		int32	R/W	2

SunSpec: 03H Read, 10H Write							
Address(H)	Address(D)	Parameters	Range	Default	Data Type	Access Property	Number of Registers
C3DDH-C3DEH	50141-50142	Total Reactive Energy: Import	0-999999999 varh		int32	R/W	2
C3DFH-C3E0H	50143-50144	Import Reactive Energy: Phase A	0-999999999 varh		int32	R/W	2
C3E1H-C3E2H	50145-50146	Import Reactive Energy: Phase B	0-999999999 varh		int32	R/W	2
C3E3H-C3E4H	50174-50148	Import Reactive Energy: Phase C	0-999999999 varh		int32	R/W	2
C3E5H	50149	Reactive Power Scale Factor	0,2(used as an exponent of a power of 10)		sunssf	R	1
C3E6H-C3E7H	50150-50151	Meter Event Flags	0		Binary	R	2
C3E8H	50152	SunSpec_end_ID: Sunspec	FFFF		int16		1
C3E9H	50153	SunSpec_end_ID: Sunspec	0		int16		1

Chapter 6: Communication Part II

6.3.17 Over/Under Alarm Setting

This setting consists of alarm settings and single channel alarm settings. Alarm settings contain settings for all variables. There are 16 groups of records with the same format.

Function code: 03H for reading, 10H for writing.

Please refer to Chapter 4 for more details.

Alarm Settings

Table 6-54

Alarm Settings: 03H Read, 10H Write					
Address(H)	Address(D)	Parameters	Range	Data Type	Access Property
1046H	4166	Alarm enable	0: Disable, 1: Enable	Word	R/W
1047H	4167	Alarm flash enable	0: Disable, 1: Enable	Word	R/W
1048H	4168	Alarm channel enable	0~65535 Bit0: Channel 1 1: Enable 0: Disable Bit1: Channel 2 .. Bit15: Channel 16	Word	R/W
1049H	4169	Logic "And" between alarm setting	0~255 Bit0: First logic switch Bit1: Second logic switch .. Bit7: Eighth logic switch	Word	R/W
104AH	4170	Alarming output to DO1 setting	0~65535 Bit0: Channel 1 output 1: Enable, 0: Disable Bit1: Channel 2 output .. Bit15: Channel 16 output	Word	R/W
104BH	4171	Alarming output to DO3 setting	0~65535 Bit0: Channel 1 output 1: Enable, 0: Disable Bit1: Channel 2 output .. Bit15: Channel 16 output	Word	R/W

Alarm Settings: 03H Read, 10H Write					
Address(H)	Address(D)	Parameters	Range	Data Type	Access Property
104CH	4172	Alarming output to DO3 setting	0~65535 Bit0: Channel 1 output 1: Enable, 0: Disable Bit1: Channel 2 output .. Bit15: Channel 16 output	Word	R/W
104DH	4173	Alarming output to DO4 setting	0~65535 Bit0: Channel 1 output 1: Enable, 0: Disable Bit1: Channel 2 output .. Bit15: Channel 16 output	Word	R/W

Single Channel Alarm Settings

Table 6-55

Single Channel Alarm Settings: 03H Read, 10H Write					
Address(H)	Address(D)	Parameters	Range	Data Type	Access Property
104EH	4174	1st group: parameter code	0~79	Word	R/W
104FH	4175	1st group: comparison mode	1: Greater than 2: Equal to 3: Less than	Word	R/W
1050H	4176	1st group: setpoint value	Related with parameters	Word	R/W
1051H	4177	1st group: delay	0~3000 (*10ms)	Word	R/W
1052H	4178	1st group: output to relay	0:none 1~8: related relay	Word	R/W
1053H	4179	2nd group: parameter code	0~79	Word	R/W
1054H	4180	2nd group: comparison mode	1: Greater than 2: Equal to 3: Less than	Word	R/W
1055H	4181	2nd group: setpoint value	Related with parameters	Word	R/W
1056H	4182	2nd group: delay	0~3000 (*10ms)	Word	R/W
1057H	4183	2nd group: output to relay	0:none 1~8: related relay	Word	R/W

Single Channel Alarm Settings: 03H Read, 10H Write					
Address(H)	Address(D)	Parameters	Range	Data Type	Access Property
1058H	4184	3rd group: parameter code	0~79	Word	R/W
1059H	4185	3rd group: comparison mode	1: Greater than 2: Equal to 3: Less than	Word	R/W
105AH	4186	3rd group: setpoint value	Related with parameters	Word	R/W
105BH	4187	3rd group: delay	0~3000 (*10ms)	Word	R/W
105CH	4188	3rd group: output to relay	0:none 1~8: related relay	Word	R/W
105DH	4189	4th group: parameter code	0~79	Word	R/W
105EH	4190	4th group: comparison mode	1: Greater than 2: Equal to 3: Less than	Word	R/W
105FH	4191	4th group: setpoint value	Related with parameters	Word	R/W
1060H	4192	4th group: delay	0~3000 (*10ms)	Word	R/W
1061H	4193	4th group: output to relay	0:none 1~8: related relay	Word	R/W
1062H	4194	5th group: parameter code	0~79	Word	R/W
1063H	4195	5th group: comparison mode	1: Greater than 2: Equal to 3: Less than	Word	R/W
1064H	4196	5th group: setpoint value	Related with parameters	Word	R/W
1065H	4197	5th group: delay	0~3000 (*10ms)	Word	R/W
1066H	4198	5th group: output to relay	0:none 1~8: related relay	Word	R/W
1067H	4199	6th group: parameter code	0~79	Word	R/W
1068H	4200	6th group: comparison mode	1: Greater than 2: Equal to 3: Less than	Word	R/W
1069H	4201	6th group: setpoint value	Related with parameters	Word	R/W
106AH	4202	6th group: delay	0~3000 (*10ms)	Word	R/W

Single Channel Alarm Settings: 03H Read, 10H Write					
Address(H)	Address(D)	Parameters	Range	Data Type	Access Property
106BH	4203	6th group: output to relay	0:none 1~8: related relay	Word	R/W
106CH	4203	7th group: parameter code	0~79	Word	R/W
106DH	4204	7th group: comparison mode	1: Greater than 2: Equal to 3: Less than	Word	R/W
106EH	4205	7th group: setpoint value	Related with parameters	Word	R/W
106FH	4206	7th group: delay	0~3000 (*10ms)	Word	R/W
1070H	4207	7th group: output to relay	0:none 1~8: related relay	Word	R/W
1071H	4208	8th group: parameter code	0~79	Word	R/W
1072H	4209	8th group: comparison mode	1: Greater than 2: Equal to 3: Less than	Word	R/W
1073H	4210	8th group: setpoint value	Related with parameters	Word	R/W
1074H	4211	8th group: delay	0~3000 (*10ms)	Word	R/W
1075H	4212	8th group: output to relay	0:none 1~8: related relay	Word	R/W
1076H	4213	9th group: parameter code	0~79	Word	R/W
1078H	4214	9th group: comparison mode	1: Greater than 2: Equal to 3: Less than	Word	R/W
1079H	4215	9th group: setpoint value	Related with parameters	Word	R/W
107AH	4216	9th group: delay	0~3000 (*10ms)	Word	R/W
107BH	4217	9th group: output to relay	0:none 1~8: related relay	Word	R/W
107CH	4218	10th group: parameter code	0~79	Word	R/W
107DH	4219	10th group: comparison mode	1: Greater than 2: Equal to 3: Less than	Word	R/W
107EH	4220	10th group: setpoint value	Related with parameters	Word	R/W

Single Channel Alarm Settings: 03H Read, 10H Write					
Address(H)	Address(D)	Parameters	Range	Data Type	Access Property
107FH	4221	10th group: delay	0~3000 (*10ms)	Word	R/W
1080H	4222	10th group: output to relay	0:none 1~8: related relay	Word	R/W
1081H	4223	11th group: parameter code	0~79	Word	R/W
1081H	4224	11th group: comparison mode	1: Greater than 2: Equal to 3: Less than	Word	R/W
1082H	4225	11th group: setpoint value	Related with parameters	Word	R/W
1083H	4226	11th group: delay	0~3000 (*10ms)	Word	R/W
1084H	4227	11th group: output to relay	0:none 1~8: related relay	Word	R/W
1085H	4228	12th group: parameter code	0~79	Word	R/W
1086H	4229	12th group: comparison mode	1: Greater than 2: Equal to 3: Less than	Word	R/W
1087H	4230	12th group: setpoint value	Related with parameters	Word	R/W
1088H	4231	12th group: delay	0~3000 (*10ms)	Word	R/W
1089H	4232	12th group: output to relay	0:none 1~8: related relay	Word	R/W
108AH	4233	13th group: parameter code	0~79	Word	R/W
108BH	4234	13th group: comparison mode	1: Greater than 2: Equal to 3: Less than	Word	R/W
108CH	4235	13th group: setpoint value	Related with parameters	Word	R/W
108DH	4236	13th group: delay	0~3000 (*10ms)	Word	R/W
108EH	4237	13th group: output to relay	0:none 1~8: related relay	Word	R/W
108FH	4238	14th group: parameter code	0~79	Word	R/W
1090H	4239	14th group: comparison mode	1: Greater than 2: Equal to 3: Less than	Word	R/W

Single Channel Alarm Settings: 03H Read, 10H Write					
Address(H)	Address(D)	Parameters	Range	Data Type	Access Property
1091H	4240	14th group: setpoint value	Related with parameters	Word	R/W
1092H	4241	14th group: delay	0~3000 (*10ms)	Word	R/W
1093H	4242	14th group: output to relay	0:none 1~8: related relay	Word	R/W
1094H	4243	15th group: parameter code	0~79	Word	R/W
1095H	4244	15th group: comparison mode	1: Greater than 2: Equal to 3: Less than	Word	R/W
1096H	4245	15th group: setpoint value	Related with parameters	Word	R/W
1097H	4246	15th group: delay	0~3000 (*10ms)	Word	R/W
1098H	4247	15th group: output to relay	0:none 1~8: related relay	Word	R/W
1099H	4248	16th group: parameter code	0~79	Word	R/W
109AH	4249	16th group: comparison mode	1: Greater than 2: Equal to 3: Less than	Word	R/W
109BH	4250	16th group: setpoint value	Related with parameters	Word	R/W
109CH	4251	16th group: delay	0~3000 (*10ms)	Word	R/W
109DH	4252	16th group: output to relay	0:none 1~8: related relay	Word	R/W

Alarming Parameter Code Table

Table 6-56

Alarming Parameter Code Table					
Setting Value	Alarming Object	Setting Value	Alarming Object	Setting Value	Alarming Object
0	Frequency	1	Va	2	Vb
3	Vc	4	Average phase voltage	5	Uab
6	Ubc	7	Uca	8	Average line voltage
9	Current of phase A	10	Current of phase B	11	Current of phase C
12	Average current	13	Neutral current	14	Power of phase A

Alarming Parameter Code Table					
Setting Value	Alarming Object	Setting Value	Alarming Object	Setting Value	Alarming Object
15	Power of phase B	16	Power of phase C	17	Power of all
18	Reactive power of phase A	19	Reactive power of phase B	20	Reactive power of phase C
21	Reactive power of all	22	Apparent power of phase A	23	Apparent power of phase B
24	Apparent power of phase C	25	Apparent power of all	26	PF of A
27	PF of B	28	PF of C	29	PF
30	Voltage unbalance factor Uunbl	31	Current unbalance factor Iunbl	32	Load characteristic (R/C/L)
33	THDV1(V1 or V12)	34	THDV2(V2 or V31)	35	THDV3(V3 or V23)
36	Average THDV	37	THDI1	38	THDI2
39	THDI3	40	Average THDI	41	AI1 sampling value
42	AI2 sampling value	43	AI3 sampling value	44	AI4 sampling value
45	Active power demand of all	46	Reactive power demand of all	47	Apparent power demand of all
48	Current demand of phase A	49	Current demand of phase B	50	Current demand of phase C

NOTE:

- When reversed phase sequence (51) is selected, whether the value of comparison mode or setpoint value is set or not will not affect alarm result and the angle of U_b to U_a will be recorded.
- When DI (52~79) is selected, whether the value of comparison mode is set or not will not affect alarm result as long as the setpoint value is set to 1, 2, or 3.
 - Stands for DI alarm is ON, recovery is OFF.
 - Stands for DI alarm is OFF, recovery is ON.
 - Stands for DI alarm is OFF, recovery is ON, and present DI status is recorded.

There are 16 groups of records with the same format. Please refer to Chapter 4 for more details.

Table 6-57

Alarming Group Records: 03H Read					
Address(H)	Address(D)	Parameters	Range	Data Type	Access Property
42A9H	17065	1st group: alarming status	0-65535	Word	R
42AAH	17066	1st group: alarming parameter code	0-79	Word	R

Alarming Group Records: 03H Read					
Address(H)	Address(D)	Parameters	Range	Data Type	Access Property
42ABH	17067	1st group: over/under limit or reset value	Related to parameter chosen	Word	R
42ACH~42B2H	17068-17074	1st group: Timestamp: yyyy:mm:dd:hh:ss:ms		Word	R
42B3H	17075	2nd group: alarming status	0-65535	Word	R
42B4H	17076	2nd group: alarming parameter code	0-79	Word	R
42B5H	17077	2nd group: over/under limit or reset value	Related to parameter chosen	Word	R
42B6H-42BCH	17078-17084	2nd group: Timestamp: yyyy:mm:dd:hh:ss:ms		Word	R
42BDH	17085	3rd group: alarming status	0-65535	Word	R
42BEH	17086	3rd group: alarming parameter code	0-79	Word	R
42BFH	17087	3rd group: over/under limit or reset value	Related to parameter chosen	Word	R
42C0H-42C6H	17088-17094	3rd group: Timestamp: yyyy:mm:dd:hh:ss:ms		Word	R
42C7H	17095	4th group: alarming status	0-65535	Word	R
42C8H	17096	4th group: alarming parameter code	0-79	Word	R
42C9H	17097	4th group: over/under limit or reset value	Related to parameter chosen	Word	R
42CAH-42D0H	17098-17104	4th group: Timestamp: yyyy:mm:dd:hh:ss:ms		Word	R
42D1H	17105	5th group: alarming status	0-65535	Word	R
42D2H	17106	5th group: alarming parameter code	0-79	Word	R
42D3H	17107	5th group: over/under limit or reset value	Related to parameter chosen	Word	R
42D4H-42DAH	170108-17114	5th group: Timestamp: yyyy:mm:dd:hh:ss:ms		Word	R
42DBH	17115	6th group: alarming status	0-65535	Word	R
42DCH	170116	6th group: alarming parameter code	0-79	Word	R
42DDH	17117	6th group: over/under limit or reset value	Related to parameter chosen	Word	R
42DEH-42E4H	17118-17124	6th group: Timestamp: yyyy:mm:dd:hh:ss:ms		Word	R
42E5H	17125	7th group: alarming status	0-65535	Word	R
42E6H	17126	7th group: alarming parameter code	0-79	Word	R
42E7H	17127	7th group: over/under limit or reset value	Related to parameter chosen	Word	R

Alarming Group Records: 03H Read					
Address(H)	Address(D)	Parameters	Range	Data Type	Access Property
42E8H-42EEH	17128-17134	7th group: Timestamp: yyy:mm:dd:hh:ss:ms		Word	R
42EFH	17135	8th group: alarming status	0-65535	Word	R
42FOH	17136	8th group: alarming parameter code	0-79	Word	R
42F1H	17137	8th group: over/under limit or reset value	Related to parameter chosen	Word	R
42F2H-42F8H	17138-17144	8th group: Timestamp: yyy:mm:dd:hh:ss:ms		Word	R
42F9H	17145	9th group: alarming status	0-65535	Word	R
42FAH	17146	9th group: alarming parameter code	0-79	Word	R
42FBH	17147	9th group: over/under limit or reset value	Related to parameter chosen	Word	R
42FCH-4302H	17148-17154	9th group: Timestamp: yyy:mm:dd:hh:ss:ms		Word	R
4303H	17155	10th group: alarming status	0-65535	Word	R
4304H	17156	10th group: alarming parameter code	0-79	Word	R
4305H	17157	10th group: over/under limit or reset value	Related to parameter chosen	Word	R
4306H-430CH	17158-17164	10th group: Timestamp: yyy:mm:dd:hh:ss:ms		Word	R
430DH	17165	11th group: alarming status	0-65535	Word	R
430EH	17166	11th group: alarming parameter code	0-79	Word	R
430FH	17167	11th group: over/under limit or reset value	Related to parameter chosen	Word	R
4310H-4316H	17168-17174	11th group: Timestamp: yyy:mm:dd:hh:ss:ms		Word	R
4317H	17175	12th group: alarming status	0-65535	Word	R
4318H	17176	12th group: alarming parameter code	0-79	Word	R
4319H	17177	12th group: over/under limit or reset value	Related to parameter chosen	Word	R
431AH-4320H	17178-17184	12th group: Timestamp: yyy:mm:dd:hh:ss:ms		Word	R
4321H	17185	13th group: alarming status	0-65535	Word	R
4322H	17186	13th group: alarming parameter code	0-79	Word	R
4323H	17187	13th group: over/under limit or reset value	Related to parameter chosen	Word	R

Alarming Group Records: 03H Read					
Address(H)	Address(D)	Parameters	Range	Data Type	Access Property
4324H-432AH	17188-17194	13th group: Timestamp: yyy:mm:dd:hh:ss:ms		Word	R
432BH	17195	14th group: alarming status	0-65535	Word	R
432CH	17196	14th group: alarming parameter code	0-79	Word	R
432DH	17197	14th group: over/under limit or reset value	Related to parameter chosen	Word	R
432EH-4334H	17198-17204	14th group: Timestamp: yyy:mm:dd:hh:ss:ms		Word	R
4335H	17205	15th group: alarming status	0-65535	Word	R
4336H	17206	15th group: alarming parameter code	0-79	Word	R
4337H	17207	15th group: over/under limit or reset value	Related to parameter chosen	Word	R
4338H-433EH	17208-17214	15th group: Timestamp: yyy:mm:dd:hh:ss:ms		Word	R
433FH	17215	16th group: alarming status	0-65535	Word	R
4340H	17216	16th group: alarming parameter code	0-79	Word	R
4341H	17217	16th group: over/under limit or reset value	Related to parameter chosen	Word	R
4342H-4348H	17218-17224	16th group: Timestamp: yyy:mm:dd:hh:ss:ms		Word	R

6.3.18 Data Logging

Data Logging Setting

In order to generate historical logs for the selected parameters, users should program the meter so that selected parameters from the corresponding Modbus registers can be copied to the historical log record. Since certain parameters occupy two registers, the programmable settings for the historical logs contain a list of descriptors to supplement this. Each descriptor lists the number of Modbus registers for the specified parameter. By combining these two lists, the historical log record can be interpreted.

For example: Registers 4002H and 4003H are programmed to be recorded by the historical log. Since 2 registers are used, the corresponding descriptor is set as 2. These registers program the log to record "Volts AN".

The historical log programmable settings are comprised of 3 blocks, one for each log. Each

log works in an identical fashion; therefore, only historical log 1 is described here. All register addresses in this section are shown within the address range of historical log 1.

1100H-11DFH (Historical Data Log 1)

11C0H-127FH (Historical Data Log 2)

1280H-133FH (Historical Data Log 3)

Block Size: 192 registers per log (384 bytes)

Data Log Setting's Address Map:

Table 6-58

Address	1100H		1101H	
Byte	0 (low byte)	1 (high byte)	2 (low byte)	3 (high byte)
Value	Sectors	Registers	Interval	

Registers: The number of registers to log in the record range from {0-117}. The size of the record in memory is [12 +(Registers x 2)].

Sectors: The number of memory sectors allocated to this log, where each sector is 64kb in size. There are 100 sectors are available for allocation among the three historical logs, and the valid allocation range is from 0~100 (When the sector is set to 0, this log is disabled).

Interval: The data capture interval for historical log records. Valid time interval can be set from 0-1440 minutes. When the interval is set to 0, the log is disabled.

NOTE: When sectors or Register or Interval is zero, the log is disabled.

Register List

Registers: 1102H-1176H

Size: 1 or 2 register(s) per parameter, 117 available registers per historical log. The register list controls which Modbus registers are recorded in each historical log record. Since many parameters, such as Voltage, Energy, etc., take up more than 1 register, multiple registers are allocated for those parameters.

For example: In order to record “Volts AN” into the historical log, Volts AN’s Modbus addresses (4002H and 4003H) are assigned and programmed to the log record list so that information can be stored into the historical log registers.

- Each unused register item should be set to 0000H or FFFFH to indicate no parameters are associated with them.
- The actual size of the record, and the number of items in the register list which are used, is determined by the registers in the header.

- Valid register address ranges that can be recorded in the historical log registers are 4000H-412BH, 4294H-42A8H, 4349H-4398H, 4500H-461BH, 4620H-463DH.

Item Descriptor List

Registers: 1177H-11B1H

Size: 1 byte per item, 117 bytes (59 registers)

While the register list describes what to log, the item descriptor list describes how to interpret that information. Each descriptor describes how many Modbus addresses are used to describe a parameter. Either 1 or 2 addresses will be used for each parameter.

For example: If the first descriptor is 2, and the second descriptor is 1, then the first 2 register items belong to the 1st descriptor, and the 3rd register item belongs to the 2nd descriptor.

NOTE: As can be seen from the example above, it is not a 1-to-1 relationship between the register list and the descriptor list. A single descriptor may refer to two register items.

Logging Time Setting

If the data logging only records one period data, or only starts from one specific time, the corresponding time and logging mode should be set accordingly for the data log function to work.

Modbus address 11B2H is used as the logging mode select. The following describes the different logging modes:

- When register 11B2H is set to 0, the logging mode is set to Mode 1 which starts logging immediately until the memory is full (First In, First Out).
- When register 11B2H is set to 1, the logging mode is set to Mode 2 which starts/ends logging based on the start/end time.
 - The start time is set in registers 11B3H-11B5H (start year, month, day, hour, minute, and second) and the end time is set in registers 11B6H-11B8H (end year, month, day, hour, minute, and second).
- When register 11B2H is set to 2, the logging mode is set to Mode 3 which starts logging at a specific time until the memory is full.
 - Only the start time should be set, only registers 11B4H-11B5H (hour and minute).

NOTE: For more details regarding the data logging function, please refer to data logging section of Chapter 4.

Registers	11B3H-11B5H (start time)	
	11B6H-11B8H (end time)	
Size	2 Registers	

Byte	0	1	2	3	4	5
Value	Month	Year	Hour	Day	Second	Minute

Log Status Block

The Log Status Block describes the current status of the log in question.

Table 6-59

Address(H)	Address(D)	Parameters	Range	Data Type	Property
6100H~6101H	24832~24833	Max records	0~468104	Dword	R
6102H~6103H	24834~24835	Used records	1~468104	Dword	R
6104H	24836	Record size	14~246	Word	R
6105H	24837	Reserved		Word	R
6106H~6108H	24838~24840	First record timestamp		Word	R
6109H~610BH	24841~24843	Last record timestamp		Word	R
6200H~620BH	25088~25099	Data Log 2 status	Same as the first group		
6300H~630BH	25344~25355	Data Log 3 status	Same as the first group		

Max Records: The maximum number of records the log can hold given the record size and sector allocation.

Used Records: The number of records stored in the log. This number will equal the Max Records when the log has filled. This value will be set to 1 when the log is reset.

Record Size: The number of bytes in this record, including the timestamp.

The record’s format in the meter is: record number (4bytes) + timestamp (6bytes) + [data1~dataN] (2Nbytes) + CRC(2bytes).

First Record Timestamp: Timestamp of the oldest record.

Last Record Timestamp: Timestamp of the newest record.

Log Retrieval Block

The log retrieval block consists of 2 parts: the header and the window. The header is used to verify the data shown within the requested log window. The window is a sliding block of data that can be used to access any record in the specified log.

Registers 6000H-6003H

Size 4 Registers

Table 6-60

Address(H)	Address(D)	Parameters	Format	Property
6000H	24576	Log type	Nnnnnnnn	R/W
			ssssssss	

Address(H)	Address(D)	Parameters	Format	Property
6001H	24577	Record number	Nnnnnnnn	R/W
		Status	wwwwwwww	
6002H~6003H	24578~24579	Offset		R/W
6004H~607EH	24580~24702	Window		R

Log type: The log to be retrieved. Write this value to set which log is being retrieved.

- 0 - Historical Log 1
- 1 - Historical Log 2
- 2 - Historical Log 3

Records Number: The number of records that fit within a window. This value is settable, and any number less than a full window may be used. This number tells the retrieving program how many records to expect to be fetched in the window. (Record number x Record Size) = bytes used in the window. This value should be $((123 \times 2) / \text{Record Size})$, rounded down. The greater the number, the faster the retrieval speed.

For example, with a record size of 50, the Records number = $((123 \times 2) / 50) = 4.92 \approx 4$.

Status: The status of the current window. Since the time to prepare a window may exceed an acceptable Modbus delay (1 second), this acts as a ready status flag to notify when the window is ready for retrieval. When this value indicates that the window is not ready, the data in the window should be ignored.

Window Status is Read-only, any writes are ignored.

This value also indicates the memory erasing status when setting the date logging settings.

BH Window is Ready

FFH Window is Not Ready

AAH memory is erasing

BBH memory erasing is finished

CXH register list is set error

X:bit0 1, register list is set error in datalogging 1;

bit1 1, register list is set error in datalogging 2;

bit2 1, register list is set error in datalogging 3.

For example **0xC6H**, register lists are error in datalogging 2 and 3

Offset: The offset of the record number of the first record in the data window and the record number of the "first record timestamp". Setting this value controls which records will be available

in the data window. When the log is retrieved, the first (oldest) record is "latched." This means that offset 0 will always point to the oldest record at the time of latching.

Window: The actual data of the records, arranged according to the above settings.

NOTE: If the logging timer is disabled, the first recording sector will be erased when the log is full. Therefore, user should not read the whole log when the used record number is near to the max record number. Under this condition, user should read the "Used Records" field and compare it to the previous "Used Records" field from the last reading before retrieving the information and reading the window.

If the current "Used Records" field is greater than the "Used Records" field from the last reading and if the "Offset" field is less than the difference between the current and previous "Used Records" field, the first sector has been erased and the difference between the "Used Records" field should be subtracted from the recording number. If the "Offset" field is greater than the difference between the current and previous "Used Records" field, the "Offset" number should be subtracted from the recording number.

To avoid this situation, user should read the log before it is almost full.

For example: Data logging 1 has 3 sectors, each has 448 records, and the total records are 1344. If you press the "Read All" button when the "Used Records" number is at 1340, and if the first sector is erased before the information is transferred to the computer, the data stored in this sector is erased permanently and cannot be retrieved. If the records from the first sector can be retrieved before it gets erased, the new value of "Offset" will equal to the original "Offset" field minus the value of the difference between the current and previous "Used Records" field.

Data logging operation examples

The following example illustrates a data logging operation. The example makes the following assumptions:

- The log is Historical Log 1.
- The log contains VAN, VBN, VCN (12 bytes), the interval is 1min, the sectors is 10, the registers is 6, the logging timer function is disabled.
- Retrieval is starting at record offset 0 (oldest record). 283
- No new records are recorded to the log during the log retrieval process.

a) Data logging settings

Now set the data log 1 according to the assumptions:

1. Set the data log with VAN, VBN, VCN. Here we should set their Modbus address

0x4002,0x4003,0x4004,0x4005,0x4006 and 0x4007 to 0x1102, 0x1103, 0x1104, 0x1105, 0x1106 and 0x1107. And the descriptor is 2, so set the 0x0202 and 0x0200 to 0x1177 and 0x1178.

2. The register is 6 and sector is 10, so we set 0x060A to 0x1100.
3. The interval is 1min, so set the 0x0001 to 0x1101.
4. The logging timer function is disabled, so set the 0 to 0x11B9.

b) Log Retrieval Procedure

The following procedure documents how to retrieve a single log from the oldest record to the newest record.

1. Compute the number of records per window, as follows:
 - $\text{RecordsPerWindow} = (246 \setminus \text{RecordSiz}) = 246 \setminus 24 = 10$
2. Write the Records per window and Record offset, in this example set the 0x0A0B and 0x0000 to 0x6001d and 0x6002. This step tells the meter what data to return in the window.
3. Read the record window status from 0x6001.
 - If the Window Status is 0xFF, go to step 2.
 - If the Window Status is 0x0B, read the data window.
4. Read the data window and compute next Expected Record offset.
 - Compute the next expected record offset by adding Records Per Window and go to step 2.
 - If there are no remaining records after the current record window, stop reading.

6.3.19 Time-of-Use

Data Address of TOU Energy

The data address saves the parameter of energy, which includes Data address of last month TOU energy, Data address of current month TOU energy, Data address of TOU parameter setting and Data address of TOU default parameter. Except for the data address of TOU default parameter, the data address is read with 03 codes, preset with 16 code.

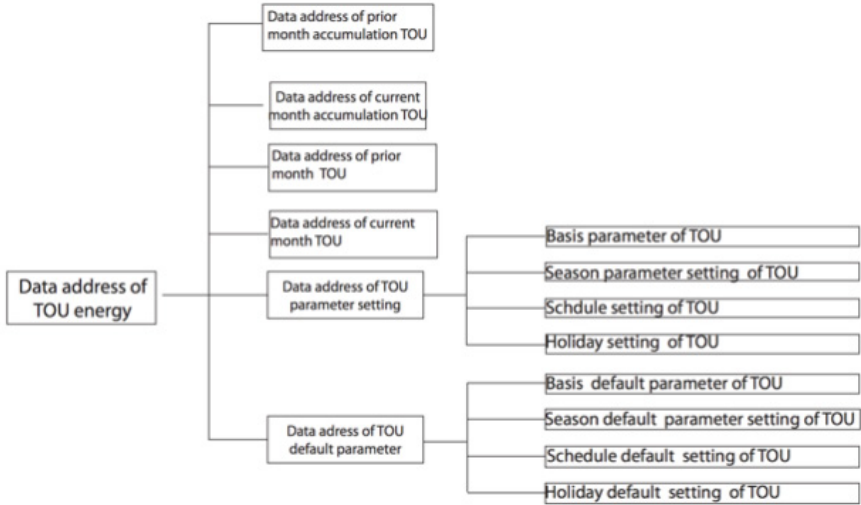

Fig 6-1 Division plan of TOU energy

Table 6-61

Address(H)	Address(D)	Parameters	Range	Data Type	Type of Access
Current month accumulation TOU energy					
7200H~7201H	29184~29185	Ep_imp (sharp)	0~999999999	Dword	R/W
7202H~7203H	29186~29187	Ep_exp (sharp)	0~999999999	Dword	R/W
7204H~7205H	29188~29189	Eq_imp (sharp)	0~999999999	Dword	R/W
7206H~7207H	29190~29191	Eq_exp (sharp)	0~999999999	Dword	R/W
7208H~7209H	29192~29193	Es (sharp)	0~999999999	Dword	R/W
720AH~720BH	29194~29195	Ep_imp (peak)	0~999999999	Dword	R/W
720CH~720DH	29196~29197	Ep_exp (peak)	0~999999999	Dword	R/W
720EH~720FH	29198~29199	Eq_imp (peak)	0~999999999	Dword	R/W

Address(H)	Address(D)	Parameters	Range	Data Type	Type of Access
7210H~7211H	29200~29201	Eq_exp (peak)	0~999999999	Dword	R/W
7212H~7213H	29202~29203	Es (peak)	0~999999999	Dword	R/W
7214H~7215H	29204~29205	Ep_imp (valley)	0~999999999	Dword	R/W
7216H~7217H	29206~29207	Ep_exp (valley)	0~999999999	Dword	R/W
7218H~7219H	29208~29209	Eq_imp (valley)	0~999999999	Dword	R/W
721AH~721BH	29210~29211	Eq_exp (valley)	0~999999999	Dword	R/W
721CH~721DH	29212~29213	Es (valley)	0~999999999	Dword	R/W
721EH~721FH	29214~29215	Ep_imp (normal)	0~999999999	Dword	R/W
7220H~7221H	29216~29217	Ep_exp (normal)	0~999999999	Dword	R/W
7222H~7223H	29218~29219	Eq_imp (normal)	0~999999999	Dword	R/W
7224H~7225H	29220~29221	Eq_exp (normal)	0~999999999	Dword	R/W
7226H~7227H	29222~29223	Es (normal)	0~999999999	Dword	R/W
7228H~7229H	29224~29225	Ep_imp (sum)	0~999999999	Dword	R/W
722AH~722BH	29226~29227	Ep_exp (sum)	0~999999999	Dword	R/W
722CH~722DH	29228~29229	Eq_imp (sum)	0~999999999	Dword	R/W
722EH~722FH	29230~29231	Eq_exp (sum)	0~999999999	Dword	R/W
7230H~7231H	29232~29233	Es (sum)	0~999999999	Dword	R/W
Current month accumulation TOU energy					
7232H~7233H	29234~29235	Ep_imp (sharp)	0~999999999	Dword	R/W
7234H~7235H	29236~29237	Ep_exp (sharp)	0~999999999	Dword	R/W
7236H~7237H	29238~29239	Eq_imp (sharp)	0~999999999	Dword	R/W
7238H~7239H	29240~29241	Eq_exp (sharp)	0~999999999	Dword	R/W
723AH~723BH	29242~29243	Es (sharp)	0~999999999	Dword	R/W
723CH~723DH	29244~29245	Ep_imp (peak)	0~999999999	Dword	R/W
723EH~723FH	29246~29247	Ep_exp (peak)	0~999999999	Dword	R/W
7240H~7241H	29248~29249	Eq_imp (peak)	0~999999999	Dword	R/W
7242H~7243H	29250~29251	Eq_exp (peak)	0~999999999	Dword	R/W
7244H~7245H	29252~29253	Es (peak)	0~999999999	Dword	R/W
7246H~7247H	29254~29255	Ep_imp (valley)	0~999999999	Dword	R/W
7248H~7249H	29256~29257	Ep_exp (valley)	0~999999999	Dword	R/W
724AH~724BH	29258~29259	Eq_imp (valley)	0~999999999	Dword	R/W

Address(H)	Address(D)	Parameters	Range	Data Type	Type of Access
724CH~724DH	29260~29261	Eq_exp (valley)	0~999999999	Dword	R/W
724EH~724FH	29262~29263	Es (valley)	0~999999999	Dword	R/W
7250H~7251H	29264~29265	Ep_imp (normal)	0~999999999	Dword	R/W
7252H~7253H	29266~29267	Ep_exp (normal)	0~999999999	Dword	R/W
7254H~7255H	29268~29269	Eq_imp (normal)	0~999999999	Dword	R/W
7256H~7257H	29270~29271	Eq_exp (normal)	0~999999999	Dword	R/W
7258H~7259H	29272~29273	Es (normal)	0~999999999	Dword	R/W
725AH~725BH	29274~29275	Ep_imp (sum)	0~999999999	Dword	R/W
725CH~725DH	29276~29277	Ep_exp (sum)	0~999999999	Dword	R/W
725EH~725FH	29278~29279	Eq_imp (sum)	0~999999999	Dword	R/W
7260H~7261H	20280~29281	Eq_exp (sum)	0~999999999	Dword	R/W
7262H~7263H	29282~29283	Es (sum)	0~999999999	Dword	R/W

Table 6-62

Address(H)	Address(D)	Parameters	Range	Data Type	Type of Access
Current month TOU energy					
7300H~7301H	29440~29441	Ep_imp (sharp)	0~999999999	Dword	R/W
7302H~7303H	29442~29443	Ep_exp (sharp)	0~999999999	Dword	R/W
7304H~7305H	29444~29445	Eq_imp (sharp)	0~999999999	Dword	R/W
7306H~7307H	29446~29447	Eq_exp (sharp)	0~999999999	Dword	R/W
7308H~7309H	29448~29449	Es (sharp)	0~999999999	Dword	R/W
730AH~730BH	29450~29451	Ep_imp (peak)	0~999999999	Dword	R/W
730CH~730DH	29452~29453	Ep_exp (peak)	0~999999999	Dword	R/W
730EH~730FH	29454~29455	Eq_imp (peak)	0~999999999	Dword	R/W
7310H~7311H	29456~29457	Eq_exp (peak)	0~999999999	Dword	R/W
7312H~7313H	29458~29459	Es (peak)	0~999999999	Dword	R/W
7314H~7315H	29460~29461	Ep_imp (valley)	0~999999999	Dword	R/W
7316H~7317H	29462~29463	Ep_exp (valley)	0~999999999	Dword	R/W
7318H~7319H	29464~29465	Eq_imp (valley)	0~999999999	Dword	R/W
731AH~731BH	29466~29467	Eq_exp (valley)	0~999999999	Dword	R/W

Address(H)	Address(D)	Parameters	Range	Data Type	Type of Access
731CH~731DH	29468~29469	Es (valley)	0~999999999	Dword	R/W
731EH~731FH	29470~29471	Ep_imp (normal)	0~999999999	Dword	R/W
7320H~7321H	29472~29473	Ep_exp (normal)	0~999999999	Dword	R/W
7322H~7323H	29474~29475	Eq_imp (normal)	0~999999999	Dword	R/W
7324H~7325H	29476~29477	Eq_exp (normal)	0~999999999	Dword	R/W
7326H~7327H	29478~29479	Es (normal)	0~999999999	Dword	R/W
7328H~7329H	29480~29481	Ep_imp (sum)	0~999999999	Dword	R/W
732AH~732BH	29482~29483	Ep_exp (sum)	0~999999999	Dword	R/W
732CH~732DH	29484~29485	Eq_imp (sum)	0~999999999	Dword	R/W
732EH~732FH	29486~29487	Eq_exp (sum)	0~999999999	Dword	R/W
7330H~7331H	29488~29489	Es (sum)	0~999999999	Dword	R/W
Prior month TOU energy					
7332H~7333H	29490~29491	Ep_imp (sharp)	0~999999999	Dword	R/W
7334H~7335H	29492~29493	Ep_exp (sharp)	0~999999999	Dword	R/W
7336H~7337H	29494~29495	Eq_imp (sharp)	0~999999999	Dword	R/W
7338H~7339H	29496~29497	Eq_exp (sharp)	0~999999999	Dword	R/W
733AH~733BH	29498~29499	Es (sharp)	0~999999999	Dword	R/W
733CH~733DH	29500~29501	Ep_imp (sharp)	0~999999999	Dword	R/W
733EH~733FH	29502~29503	Ep_exp (sharp)	0~999999999	Dword	R/W
7340H~7341H	29504~29505	Eq_imp (sharp)	0~999999999	Dword	R/W
7342H~7343H	29506~29507	Eq_exp (sharp)	0~999999999	Dword	R/W
7344H~7345H	29508~29509	Es (sharp)	0~999999999	Dword	R/W
7346H~7347H	29510~29511	Ep_imp (sharp)	0~999999999	Dword	R/W
7348H~7349H	29512~29513	Ep_exp (sharp)	0~999999999	Dword	R/W
734AH~734BH	29514~29515	Eq_imp (sharp)	0~999999999	Dword	R/W
734CH~734DH	29516~29517	Eq_exp (sharp)	0~999999999	Dword	R/W
734EH~734FH	29518~29219	Es (sharp)	0~999999999	Dword	R/W
7350H~7351H	29220~29221	Ep_imp (sharp)	0~999999999	Dword	R/W
7352H~7353H	29222~29223	Ep_exp (sharp)	0~999999999	Dword	R/W
7354H~7355H	29224~29225	Eq_imp (sharp)	0~999999999	Dword	R/W
7356H~7357H	29226~29227	Eq_exp (sharp)	0~999999999	Dword	R/W

Address(H)	Address(D)	Parameters	Range	Data Type	Type of Access
7358H~7359H	29228~29229I	Es (sharp)	0~999999999	Dword	R/W
735AH~735BH	29230~29231	Ep_imp (sharp)	0~999999999	Dword	R/W
735CH~735DH	29232~29233	Ep_exp (sharp)	0~999999999	Dword	R/W
735EH~735FH	29234~29235	Eq_imp (sharp)	0~999999999	Dword	R/W
7360H~7361H	29236~29237	Eq_exp (sharp)	0~999999999	Dword	R/W
7362H~7363H	29538~29539	Es (sharp)	0~999999999	Dword	R/W

The address area includes the max of Ep_imp, Ep_exp, Eq_imp, Eq_exp, Es, Current demand, and timestamp, when tariff setting parameters are sharp, peak, valley, and normal. Function: 03H Read.

Table 6-63

Address(H)	Address(D)	Parameters	Range	Data Type	Type of Access
7500H~7503H	29952~29955	Max of Ep_imp (sharp) demand and timestamp (format: power; year/month; Day/Hour; Min/Sec)	- 32768~32767	Int	R
7504H~7507H	29956~29959	Max of Ep_exp (sharp) demand and timestamp	- 32768~32767	Int	R
7508H~750BH	29960~29963	Max of Eq_imp (sharp) demand and timestamp	- 32768~32767	Int	R
750CH~750FH	29964~29967	Max of Eq_exp (sharp) demand and timestamp	- 32768~32767	Int	R
7510H~7513H	29968~29971	Max of Es (sharp) demand and timestamp	- 32768~32767	Int	R
7514H~7517H	29972~29975	Max of Ia (sharp) demand and timestamp	- 32768~32767	Int	R
7518H~751BH	29976~29979	Max of Ib (sharp) demand and timestamp	- 32768~32767	Int	R
751CH~751FH	29980~29983	Max of Ic (sharp) demand and timestamp	- 32768~32767	Int	R
7520H~7523H	29984~29987	Max of Ep_imp (peak) demand and timestamp	- 32768~32767	Int	R
7524H~7527H	29988~29991	Max of Ep_exp (peak) demand and timestamp	- 32768~32767	Int	R
7528H~752BH	29992~29995	Max of Eq_imp (peak) demand and timestamp	- 32768~32767	Int	R
752CH~752FH	29996~29999	Max of Eq_exp (peak) demand and timestamp	- 32768~32767	Int	R

Address(H)	Address(D)	Parameters	Range	Data Type	Type of Access
7530H-7533H	30000-30003	Max of Es (peak) demand and timestamp	- 32768-32767	Int	R
7534H-7537H	30004-30007	Max of Ia (peak) demand and timestamp	- 32768-32767	Int	R
7538H-753BH	30008-30011	Max of Ib (peak) demand and timestamp	- 32768-32767	Int	R
753CH-753FH	30012-30015	Max of Ic (peak) demand and timestamp	- 32768-32767	Int	R
7540H-7543H	30016-30019	Max of Ep_imp (valley) demand and timestamp	- 32768-32767	Int	R
7544H-7547H	30020-30023	Max of Ep_exp (valley) demand and timestamp	- 32768-32767	Int	R
7548H-754BH	30024-30027	Max of Eq_imp (valley) demand and timestamp	- 32768-32767	Int	R
754CH-754FH	30028-30031	Max of Eq_exp (valley) demand and timestamp	- 32768-32767	Int	R
7550H-7553H	30032-30035	Max of Es (valley) demand and timestamp	- 32768-32767	Int	R
7554H-7557H	30036-30039	Max of Ia (valley) demand and timestamp	- 32768-32767	Int	R
7558H-755BH	30040-30043	Max of Ib (valley) demand and timestamp	- 32768-32767	Int	R
755CH-755FH	30044-30047	Max of Ic (valley) demand and timestamp	- 32768-32767	Int	R
7560H-7563H	30048-30051	Max of Ep_imp (normal) demand and timestamp	- 32768-32767	Int	R
7564H-7567H	30052-30055	Max of Ep_exp (normal) demand and timestamp	- 32768-32767	Int	R
7568H-756BH	30056-30059	Max of Eq_imp (normal) demand and timestamp	- 32768-32767	Int	R
756CH-756FH	30060-30063	Max of Eq_exp (normal) demand and timestamp	- 32768-32767	Int	R
7570H-7573H	30064-30067	Max of Es (normal) demand and timestamp	- 32768-32767	Int	R
7574H-7577H	30068-30071	Max of Ia (normal) demand and timestamp	- 32768-32767	Int	R
7578H-757BH	30072-30075	Max of Ib (normal) demand and timestamp	- 32768-32767	Int	R
757CH-757FH	30076-30079	Max of Ic (normal) demand and timestamp	- 32768-32767	Int	R
7580H-7583H	30080-30083	Max of Ep_imp (all) demand and timestamp	- 32768-32767	Int	R

Address(H)	Address(D)	Parameters	Range	Data Type	Type of Access
7584H-7587H	30084-30087	Max of Ep_exp (all) demand and timestamp	- 32768-32767	Int	R
7588H-758BH	30088-30091	Max of Eq_imp (all) demand and timestamp	- 32768-32767	Int	R
758CH-758FH	30092-30095	Max of Eq_exp (all) demand and timestamp	- 32768-32767	Int	R
7590H-7593H	30096-30099	Max of Es (all) demand and timestamp	- 32768-32767	Int	R
7594H-7597H	30100-30103	Max of Ia (all) demand and timestamp	- 32768-32767	Int	R
7598H-759BH	30104-30107	Max of Ib (all) demand and timestamp	- 32768-32767	Int	R
759CH-759FH	30108-30111	Max of Ic (all) demand and timestamp	- 32768-32767	Int	R

The address area includes Daylight savings time (DST) setting. Function: 03H Read, 10H Preset.

Table 6-64

Address(H)	Address(D)	Parameters	Range	Data Type	Type of Access
7700H	30464	DST enable	0: Disable, 1: Enable	Word	R/W
7701H	30465	DST format	0: Format 1, 1: Format 2	Word	R/W
Format 1					
7702H	30466	DST start Mon	1~12	Word	R/W
7703H	30467	DST start Day	1~31	Word	R/W
7704H	30468	DST start Hour	0~23	Word	R/W
7705H	30469	DST start Min	0~59	Word	R/W
7706H	30470	DST start adjust time (Unit: Min)	1~120 (Default: 60)	Word	R/W
7707H	30471	DST ending Mon	1~12	Word	R/W
7708H	30472	DST ending Day	1~31	Word	R/W
7709H	30473	DST ending Hour	0~23	Word	R/W
770AH	30474	DST ending Min	0~59	Word	R/W
770BH	30475	DST ending adjust time (Unit: Min)	1~120 (Default: 60)	Word	R/W
Format 2					
770CH	30476	DST start Mon	1~12	Word	R/W

Address(H)	Address(D)	Parameters	Range	Data Type	Type of Access
770DH	30477	DST start Week	0: Sunday 1~6, Monday to Saturday	Word	R/W
770EH	30478	DST start first few Weeks	1~5	Word	R/W
770FH	30479	DST start Hour	0~23	Word	R/W
7710H	30480	DST start Min	0~59	Word	R/W
7711H	30481	DST start adjust time (Unit: Min)	1~120 (Default: 60)	Word	R/W
7712H	30482	DST ending Mon	1~12	Word	R/W
7713H	30483	DST ending Week	0: Sunday 1~6, Monday to Saturday	Word	R/W
7714H	30484	DST ending first few Weeks	1~5	Word	R/W
7715H	30485	DST ending Hour	0~23	Word	R/W
7716H	30486	DST ending Min	0~59	Word	R/W
7717H	30487	DST ending adjust time (Unit: Min)	1~120 (Default: 60)	Word	R/W

Data address of TOU parameter setting includes basis parameter of TOU, time zone setting parameter of TOU, timetable setting parameter of TOU, and holiday setting parameter of TOU. Function: 03 code, 10 reset.

Table 6-65

Address(H)	Address(D)	Parameters	Range	Data Type	Type of Access
Basis parameter of TOU					
7800H	30720	Season number	0~12	Word	R/W
7801H	30721	Schedule number	0~14	Word	R/W
7802H	30722	Segment number	0~14	Word	R/W
7803H	30723	Tariff number	0~3	Word	R/W
7804H	30724	Weekend setting (bit0-Sunday; bit 1~bit6: Monday~Saturday bit=1 means using energy, bit=0 means not using energy)	0~127	Word	R/W
7805H	30725	Weekend schedule	0~14	Word	R/W
7806H	30726	Holiday number	0~30	Word	R/W

Address(H)	Address(D)	Parameters	Range	Data Type	Type of Access
7807H	30727	TOU factory setting	1: Enable	Word	R/W
7808H	30728	Choice of calculation auto reset (0: End of Month)	1: Enable	Word	R/W
7809H	30729	TOU auto reset fixed date: day (default is 1)		Word	R/W
780AH	30730	TOU auto reset fixed date: hour (default is 0)	0~31	Word	R/W
780BH	30731	TOU auto reset fixed date: minute (default is 0)	0~23	Word	R/W
780CH	30732	TOU auto reset fixed date: second (default is 0)	0~59	Word	R/W
780DH	30733	TOU auto reset fixed date: second (default is 0)	0~59	Word	R/W
780EH	30734	Error code (default is 0)	0: the setting of parameter is correct; 1: tariff setting error; 2: schedule setting error, 4: segment setting error; 8: season setting error; 16: parameter of season setting error; 32: holiday setting error; 64: parameter of holiday setting error; 256: tariff of schedule setting error; 512: time of schedule setting error; 1024: period of schedule setting error; 2048: period of weekend setting error; 4096: weekend setting error	Word	R/W
Season setting					
7820H~7822H	30752~30754	Data and season table of the 1st season		Word	R/W

Address(H)	Address(D)	Parameters	Range	Data Type	Type of Access
7823H~7825H	30755~30757	Data and season table of the 2nd season		Word	R/W
7826H~7828H	30758~30760	Data and season table of the 3rd season		Word	R/W
7829H~782BH	30761~30763	Data and season table of the 4th season		Word	R/W
782CH~782EH	30764~30766	Data and season table of the 5th season		Word	R/W
782FH~7831H	30767~30769	Data and season table of the 6th season		Word	R/W
7832H~7834H	30770~30772	Data and season table of the 7th season		Word	R/W
7835H~7837H	30773~30775	Data and season table of the 8th season		Word	R/W
7838H~783AH	30776~30778	Data and season table of the 9th season		Word	R/W
783BH~783DH	30779~30781	Data and season table of the 10th season		Word	R/W
783EH~7840H	30782~30784	Data and season table of the 11th season		Word	R/W
7841H~7843H	30785~30787	Data and season table of the 12th season		Word	R/W
Schedule setting					
7844H~7846H	30788~30790	1st segment and tariff number of the 1st schedule		Word	R/W
7847H~7849H	30791~30793	2nd segment and tariff number of the 1st schedule		Word	R/W
784AH~784CH	30794~30796	3rd segment and tariff number of the 1st schedule		Word	R/W
784DH~784FH	30797~30799	4th segment and tariff number of the 1st schedule		Word	R/W
7850H~7852H	30800~30802	5th segment and tariff number of the 1st schedule		Word	R/W
7853H~7855H	30803~30805	6th segment and tariff number of the 1st schedule		Word	R/W
7856H~7858H	30806~30808	7th segment and tariff number of the 1st schedule		Word	R/W
7859H~785BH	30809~30811	8th segment and tariff number of the 1st schedule		Word	R/W
785CH~785EH	30812~30814	9th segment and tariff number of the 1st schedule		Word	R/W

Acuvim II Series Power Meter

Address(H)	Address(D)	Parameters	Range	Data Type	Type of Access
785FH~7861H	30815~30817	10th segment and tariff number of the 1st schedule		Word	R/W
7862H~7864H	30818~30820	11th segment and tariff number of the 1st schedule		Word	R/W
7865H~7867H	30821~30823	12th segment and tariff number of the 1st schedule		Word	R/W
7868H~786AH	30824~30826	13th segment and tariff number of the 1st schedule		Word	R/W
786BH~786DH	30827~30829	14th segment and tariff number of the 1st schedule		Word	R/W
786EH~7897H	30830~30871	From 1st to 14th segment and tariff number of the 2nd schedule	The same as the 1st schedule	Word	R/W
7898H~78C1H	30872~30913	From 1st to 14th segment and tariff number of the 3rd schedule	The same as the 1st schedule	Word	R/W
78C2H~78EBH	30914~30955	From 1st to 14th segment and tariff number of the 4th schedule	The same as the 1st schedule	Word	R/W
78ECH~7915H	30956~30997	From 1st to 14th segment and tariff number of the 5th schedule	The same as the 1st schedule	Word	R/W
7916H~793FH	30998~31039	From 1st to 14th segment and tariff number of the 6th schedule	The same as the 1st schedule	Word	R/W
7940H~7969H	31040~31081	From 1st to 14th segment and tariff number of the 7th schedule	The same as the 1st schedule	Word	R/W
796AH~7993H	31082~31123	From 1st to 14th segment and tariff number of the 8th schedule	The same as the 1st schedule	Word	R/W
7994H~79BDH	31124~31165	From 1st to 14th segment and tariff number of the 9th schedule	The same as the 1st schedule	Word	R/W
79BEH~79E7H	31166~31207	From 1st to 14th segment and tariff number of the 10th schedule	The same as the 1st schedule	Word	R/W
79E8H~7A11H	31208~31249	From 1st to 14th segment and tariff number of the 11th schedule	The same as the 1st schedule	Word	R/W
7A12H~7A3BH	31250~31291	From 1st to 14th segment and tariff number of the 12th schedule	The same as the 1st schedule	Word	R/W

Address(H)	Address(D)	Parameters	Range	Data Type	Type of Access
7A3CH~7A65H	31292~31333	From 1st to 14th segment and tariff number of the 13th schedule	The same as the 1st schedule	Word	R/W
7A66H~7A8FH	31334~31375	From 1st to 14th segment and tariff number of the 14th schedule	The same as the 1st schedule	Word	R/W
Holiday setting					
7A90H~7A92H	31376~31378	Data and the schedule of the 1st holiday		Word	R/W
7A93H~7A95H	31379~31381	Data and the schedule of the 2nd holiday		Word	R/W
7A96H~7A98H	31382~31384	Data and the schedule of the 3rd holiday		Word	R/W
7A99H~7A9BH	31385~31387	Data and the schedule of the 4th holiday		Word	R/W
7A9CH~7A9EH	31388~31390	Data and the schedule of the 5th holiday		Word	R/W
7A9FH~7AA1H	31391~31393	Data and the schedule of the 6th holiday		Word	R/W
7AA2H~7AA4H	31394~31396	Data and the schedule of the 7th holiday		Word	R/W
7AA5H~7AA7H	31397~31399	Data and the schedule of the 8th holiday		Word	R/W
7AA8H~7AAAH	31400~31402	Data and the schedule of the 9th holiday		Word	R/W
7AABH~7AADH	31403~31405	Data and the schedule of the 10th holiday		Word	R/W
7AAEH~7AB0H	31406~31408	Data and the schedule of the 11th holiday		Word	R/W
7AB1H~7AB3H	31409~31411	Data and the schedule of the 12th holiday		Word	R/W
7AB4H~7AB6H	31412~31414	Data and the schedule of the 13th holiday		Word	R/W
7AB7H~7AB9H	31415~31417	Data and the schedule of the 14th holiday		Word	R/W
7ABAH~7ABCH	31418~31420	Data and the schedule of the 15th holiday		Word	R/W
7ABDH~7ABFH	31421~31423	Data and the schedule of the 16th holiday		Word	R/W

Address(H)	Address(D)	Parameters	Range	Data Type	Type of Access
7AC0H~7AC2H	31424~31426	Data and the schedule of the 17th holiday		Word	R/W
7AC3H~7AC5H	31427~31429	Data and the schedule of the 18th holiday		Word	R/W
7AC6H~7AC8H	31430~31432	Data and the schedule of the 19th holiday		Word	R/W
7AC9H~7ACBH	31433~31435	Data and the schedule of the 20th holiday		Word	R/W
7ACCH~7ACEH	31436~31438	Data and the schedule of the 21st holiday		Word	R/W
7ACFH~7AD1H	31439~31441	Data and the schedule of the 22nd holiday		Word	R/W
7AD2H~7AD4H	31442~31444	Data and the schedule of the 23rd holiday		Word	R/W
7AD5H~7AD7H	31445~31447	Data and the schedule of the 24th holiday		Word	R/W
7AD8H~7ADAH	31448~31450	Data and the schedule of the 25th holiday		Word	R/W
7ADBH~7ADDH	31451~31453	Data and the schedule of the 26th holiday		Word	R/W
7ADEH~7AE0H	31454~31456	Data and the schedule of the 27th holiday		Word	R/W
7AE1H~7AE3H	31457~31459	Data and the schedule of the 28th holiday		Word	R/W
7AE4H~7AE6H	31460~31462	Data and the schedule of the 29th holiday		Word	R/W
7AE7H~7AE9H	31463~31465	Data and the schedule of the 30th holiday		Word	R/W
7AEA H	31466	Holiday setting enable		Word	R/W
7AEBH	31467	Start year holiday setting		Word	R/W
7AECH	31468	End year holiday setting		Word	R/W

The address area includes ten years holiday setting, Function: 03H Read 10H Preset.

Table 6-66

The 1st Year Holiday Address Function: 03H Read 10H Preset				
Address(H)	Address(D)	Parameters	Data Type	Type of Access
7B00H~7B02H	31488~31490	The 1st holiday and schedule (format: month/day/schedule)	Word	R/W
7B03H~7B05H	31491~31493	The 2nd holiday and schedule	Word	R/W
7B06H~7B08H	31494~31496	The 3rd holiday and schedule	Word	R/W
7B09H~7B0BH	31497~31499	The 4th holiday and schedule	Word	R/W
7B0CH~7B0EH	31500~31502	The 5th holiday and schedule	Word	R/W
7B0FH~7B11H	31503~31505	The 6th holiday and schedule	Word	R/W
7B12H~7B14H	31506~31508	The 7th holiday and schedule	Word	R/W
7B15H~7B17H	31509~31511	The 8th holiday and schedule	Word	R/W
7B18H~7B1AH	31512~31514	The 9th holiday and schedule	Word	R/W
7B1BH~7B1DH	31515~31517	The 10th holiday and schedule	Word	R/W
7B1EH~7B20H	31518~31520	The 11th holiday and schedule	Word	R/W
7B21H~7B23H	31521~31523	The 12th holiday and schedule	Word	R/W
7B24H~7B26H	31524~31526	The 13th holiday and schedule	Word	R/W
7B27H~7B29H	31527~31529	The 14th holiday and schedule	Word	R/W
7B2AH~7B2CH	31530~31532	The 15th holiday and schedule	Word	R/W
7B2DH~7B2FH	31533~31535	The 16th holiday and schedule	Word	R/W
7B30H~7B32H	31536~31538	The 17th holiday and schedule	Word	R/W
7B33H~7B35H	31539~31541	The 18th holiday and schedule	Word	R/W
7B36H~7B38H	31542~31544	The 19th holiday and schedule	Word	R/W
7B39H~7B3BH	31545~31547	The 20th holiday and schedule	Word	R/W
7B3CH~7B3EH	31548~31550	The 21st holiday and schedule	Word	R/W
7B3FH~7B41H	31551~31553	The 22nd holiday and schedule	Word	R/W
7B42H~7B44H	31554~31556	The 23rd holiday and schedule	Word	R/W
7B45H~7B47H	31557~31559	The 24th holiday and schedule	Word	R/W
7B48H~7B4AH	31560~31562	The 25th holiday and schedule	Word	R/W
7B4BH~7B4DH	31563~31565	The 26th holiday and schedule	Word	R/W
7B4EH~7B50H	31566~31568	The 27th holiday and schedule	Word	R/W
7B51H~7B53H	31569~31571	The 28th holiday and schedule	Word	R/W
7B54H~7B56H	31572~31574	The 29th holiday and schedule	Word	R/W
7B57H~7B59H	31575~31577	The 30th holiday and schedule	Word	R/W

The 1st Year Holiday Address Function: 03H Read 10H Preset				
Address(H)	Address(D)	Parameters	Data Type	Type of Access
7B5AH	31578	The 1st setting year	Word	R/W
7b5BH	31579	Holiday number of the 1st year	Word	R/W

Table 6-67

The 2nd Year Holiday Address Function: 03H Read 10H Preset				
Address(H)	Address(D)	Parameters	Data Type	Type of Access
7B5CH~7B5EH	31580~31582	The 1st holiday and schedule (format: month/day/schedule)	Word	R/W
7B5FH~7B61H	31583~31585	The 2nd holiday and schedule	Word	R/W
7B62H~7B64H	31586~31588	The 3rd holiday and schedule	Word	R/W
7B65H~7B67H	31589~31591	The 4th holiday and schedule	Word	R/W
7B68H~7B6AH	31592~31594	The 5th holiday and schedule	Word	R/W
7B6BH~7B6DH	31595~31597	The 6th holiday and schedule	Word	R/W
7B6EH~7B70H	31598~31600	The 7th holiday and schedule	Word	R/W
7B71H~7B73H	31601~31603	The 8th holiday and schedule	Word	R/W
7B74H~7B76H	31604~31606	The 9th holiday and schedule	Word	R/W
7B77H~7B79H	31607~31609	The 10th holiday and schedule	Word	R/W
7B7AH~7B7CH	31610~31612	The 11th holiday and schedule	Word	R/W
7B7DH~7B7FH	31613~31615	The 12th holiday and schedule	Word	R/W
7B80H~7B82H	31616~31618	The 13th holiday and schedule	Word	R/W
7B83H~7B85H	31619~31621	The 14th holiday and schedule	Word	R/W
7B86H~7B88H	31622~31624	The 15th holiday and schedule	Word	R/W
7B89H~7B8BH	31625~31627	The 16th holiday and schedule	Word	R/W
7B8CH~7B8EH	31628~31630	The 17th holiday and schedule	Word	R/W
7B8FH~7B91H	31631~31633	The 18th holiday and schedule	Word	R/W
7B92H~7B94H	31634~31636	The 19th holiday and schedule	Word	R/W
7B95H~7B97H	31637~31639	The 20th holiday and schedule	Word	R/W
7B98H~7B9AH	31640~31642	The 21st holiday and schedule	Word	R/W
7B9BH~7B9DH	31643~31645	The 22nd holiday and schedule	Word	R/W
7B9EH~7BA0H	31646~31648	The 23rd holiday and schedule	Word	R/W

The 2nd Year Holiday Address Function: 03H Read 10H Preset				
Address(H)	Address(D)	Parameters	Data Type	Type of Access
7BA1H~7BA3H	31649~31651	The 24th holiday and schedule	Word	R/W
7BA4H~7BA6H	31652~31654	The 25th holiday and schedule	Word	R/W
7BA7H~7BA9H	31655~31657	The 26th holiday and schedule	Word	R/W
7BAAH~7BACH	31658~31660	The 27th holiday and schedule	Word	R/W
7BADH~7BAFH	31661~31663	The 28th holiday and schedule	Word	R/W
7BB0H~7BB2H	31664~31666	The 29th holiday and schedule	Word	R/W
7BB3H~7BB5H	31667~31669	The 30th holiday and schedule	Word	R/W
7BB6H	31670	The 2nd setting year	Word	R/W
7BB7H	31671	Holiday number of the 2nd year	Word	R/W

Table 6-68

The 3rd Year Holiday Address Function: 03H Read 10H Preset				
Address(H)	Address(D)	Parameters	Data Type	Type of Access
7BB8H~7BBAH	31672~31674	The 1st holiday and schedule (format: month/day/schedule)	Word	R/W
7BBBH~7BBDH	31675~31677	The 2nd holiday and schedule	Word	R/W
7BBEH~7BC0H	31678~31680	The 3rd holiday and schedule	Word	R/W
7BC1H~7BC3H	31681~31683	The 4th holiday and schedule	Word	R/W
7BC4H~7BC6H	31684~31686	The 5th holiday and schedule	Word	R/W
7BC7H~7BC9H	31687~31689	The 6th holiday and schedule	Word	R/W
7BCAH~7BCCH	31690~31692	The 7th holiday and schedule	Word	R/W
7BCDH~7BCFH	31693~31695	The 8th holiday and schedule	Word	R/W
7BD0H~7BD2H	31696~31698	The 9th holiday and schedule	Word	R/W
7BD3H~7BD5H	31699~31701	The 10th holiday and schedule	Word	R/W
7BD6H~7BD8H	31702~31704	The 11th holiday and schedule	Word	R/W
7BD9H~7BDBH	31705~31707	The 12th holiday and schedule	Word	R/W
7BDCH~7BDEH	31708~31710	The 13th holiday and schedule	Word	R/W
7BDFH~7BE1H	31711~31713	The 14th holiday and schedule	Word	R/W
7BE2H~7BE4H	31714~31716	The 15th holiday and schedule	Word	R/W
7BE5H~7BE7H	31717~31719	The 16th holiday and schedule	Word	R/W

The 3rd Year Holiday Address Function: 03H Read 10H Preset				
Address(H)	Address(D)	Parameters	Data Type	Type of Access
7BE8H~7BEAH	31720~31722	The 17th holiday and schedule	Word	R/W
7BEBH~7BEDH	31723~31725	The 18th holiday and schedule	Word	R/W
7BEEH~7BF0H	31726~31728	The 19th holiday and schedule	Word	R/W
7BF1H~7BF3H	31729~31731	The 20th holiday and schedule	Word	R/W
7BF4H~7BF6H	31732~31734	The 21st holiday and schedule	Word	R/W
7BF7H~7BF9H	31735~31737	The 22nd holiday and schedule	Word	R/W
7BFAH~7BFCH	31738~31740	The 23rd holiday and schedule	Word	R/W
7BFDH~7BFFH	31741~31743	The 24th holiday and schedule	Word	R/W
7C00H~7C02H	31744~31746	The 25th holiday and schedule	Word	R/W
7C03H~7C05H	31747~31749	The 26th holiday and schedule	Word	R/W
7C06H~7C08H	31750~31752	The 27th holiday and schedule	Word	R/W
7C09H~7C0BH	31753~31755	The 28th holiday and schedule	Word	R/W
7C0CH~7C0EH	31756~31758	The 29th holiday and schedule	Word	R/W
7C0FH~7C11H	31759~31761	The 30th holiday and schedule	Word	R/W
7C12H	31762	The 3rd setting year	Word	R/W
7C13H	31763	Holiday number of the 3rd year	Word	R/W

Table 6-69

The 4th Year Holiday Address Function: 03H Read 10H Preset				
Address(H)	Address(D)	Parameters	Data Type	Type of Access
7C14H~7C16H	31764~31766	The 1st holiday and schedule (format: month/day/schedule)	Word	R/W
7C17H~7C19H	31767~31769	The 2nd holiday and schedule	Word	R/W
7C1AH~7C1CH	31770~31772	The 3rd holiday and schedule	Word	R/W
7C1DH~7C1FH	31773~31775	The 4th holiday and schedule	Word	R/W
7C20H~7C22H	31776~31778	The 5th holiday and schedule	Word	R/W
7C23H~7C25H	31779~31871	The 6th holiday and schedule	Word	R/W
7C26H~7C28H	31782~31874	The 7th holiday and schedule	Word	R/W
7C29H~7C2BH	31785~31787	The 8th holiday and schedule	Word	R/W
7C2CH~7C22H	31788~31790	The 9th holiday and schedule	Word	R/W

The 4th Year Holiday Address Function: 03H Read 10H Preset				
Address(H)	Address(D)	Parameters	Data Type	Type of Access
7C2FH~7C31H	31791~31793	The 10th holiday and schedule	Word	R/W
7C32H~7C34H	31794~31796	The 11th holiday and schedule	Word	R/W
7C35H~7C37H	31797~31799	The 12th holiday and schedule	Word	R/W
7C38H~7C3AH	31800~31802	The 13th holiday and schedule	Word	R/W
7C3BH~7C3DH	31803~31805	The 14th holiday and schedule	Word	R/W
7C3EH~7C40H	31806~31808	The 15th holiday and schedule	Word	R/W
7C41H~7C43H	31809~31811	The 16th holiday and schedule	Word	R/W
7C44H~7C46H	31812~31814	The 17th holiday and schedule	Word	R/W
7C47H~7C49H	31815~31817	The 18th holiday and schedule	Word	R/W
7C4AH~7C4CH	31818~31820	The 19th holiday and schedule	Word	R/W
7C4DH~7C4FH	31821~31823	The 20th holiday and schedule	Word	R/W
7C50H~7C52H	31824~31826	The 21st holiday and schedule	Word	R/W
7C53H~7C55H	31827~31829	The 22nd holiday and schedule	Word	R/W
7C56H~7C58H	31830~31832	The 23rd holiday and schedule	Word	R/W
7C59H~7C5BH	31833~31835	The 24th holiday and schedule	Word	R/W
7C5CH~7C5EH	31836~31838	The 25th holiday and schedule	Word	R/W
7C5FH~7C61H	31839~31841	The 26th holiday and schedule	Word	R/W
7C62H~7C64H	31842~31844	The 27th holiday and schedule	Word	R/W
7C65H~7C67H	31845~31847	The 28th holiday and schedule	Word	R/W
7C68H~7C6AH	31848~31850	The 29th holiday and schedule	Word	R/W
7C68H~7C6AH	31851~31853	The 30th holiday and schedule	Word	R/W
7C6EH	31854	The 4th setting year	Word	R/W
7C6FH	31855	Holiday number of the 4th year	Word	R/W

Table 6-70

The 5th Year Holiday Address Function: 03H Read 10H Preset				
Address(H)	Address(D)	Parameters	Data Type	Type of Access
7C70H~7C72H	31856~31858	The 1st holiday and schedule (format: month/day/schedule)	Word	R/W
7C73H~7C75H	31859~31861	The 2nd holiday and schedule	Word	R/W

The 5th Year Holiday Address Function: 03H Read 10H Preset				
Address(H)	Address(D)	Parameters	Data Type	Type of Access
7C76H~7C78H	31862~31864	The 3rd holiday and schedule	Word	R/W
7C79H~7C7BH	31865~31867	The 4th holiday and schedule	Word	R/W
7C7CH~7C7EH	31868~31870	The 5th holiday and schedule	Word	R/W
7C7FH~7C81H	31871~31873	The 6th holiday and schedule	Word	R/W
7C82H~7C84H	31874~31876	The 7th holiday and schedule	Word	R/W
7C85H~7C87H	31877~31879	The 8th holiday and schedule	Word	R/W
7C88H~7C8AH	31880~31882	The 9th holiday and schedule	Word	R/W
7C8BH~7C8DH	31883~31885	The 10th holiday and schedule	Word	R/W
7C8EH~7C90H	31886~31888	The 11th holiday and schedule	Word	R/W
7C91H~7C93H	31889~31891	The 12th holiday and schedule	Word	R/W
7C94H~7C96H	31892~31894	The 13th holiday and schedule	Word	R/W
7C97H~7C99H	31895~31897	The 14th holiday and schedule	Word	R/W
7C3EH~7C40H	31898~31900	The 15th holiday and schedule	Word	R/W
7C9DH~7C9FH	31901~31903	The 16th holiday and schedule	Word	R/W
7CA0H~7CA2H	31904~31906	The 17th holiday and schedule	Word	R/W
7CA3H~7CA5H	31907~31909	The 18th holiday and schedule	Word	R/W
7CA6H~7CA8H	31910~31912	The 19th holiday and schedule	Word	R/W
7CA9H~7CABH	31913~31915	The 20th holiday and schedule	Word	R/W
7CAC~7CAEH	31916~31918	The 21st holiday and schedule	Word	R/W
7CAFH~7CB1H	31919~31921	The 22nd holiday and schedule	Word	R/W
7CB2H~7CB4H	31922~31924	The 23rd holiday and schedule	Word	R/W
7CB5H~7CB7H	31925~31927	The 24th holiday and schedule	Word	R/W
7CB8H~7CBAH	31928~31930	The 25th holiday and schedule	Word	R/W
7CBBH~7CBDH	31931~31933	The 26th holiday and schedule	Word	R/W
7CBEH~7CC0H	31934~31936	The 27th holiday and schedule	Word	R/W
7CC1H~7CC3H	31937~31939	The 28th holiday and schedule	Word	R/W
7CC4H~7CC6H	31940~31942	The 29th holiday and schedule	Word	R/W
7CC7H~7CC9H	31943~31945	The 30th holiday and schedule	Word	R/W
7CCAH	31946	The 5th setting year	Word	R/W
7CCBH	31947	Holiday number of the 5th year	Word	R/W

Table 6-71

The 6th Year Holiday Address Function: 03H Read 10H Preset				
Address(H)	Address(D)	Parameters	Data Type	Type of Access
7CCCH~7CCEH	31948~31950	The 1st holiday and schedule (format: month/day/schedule)	Word	R/W
7CCFH~7CD1H	31951~31953	The 2nd holiday and schedule	Word	R/W
7CD2H~7CD4H	31954~31956	The 3rd holiday and schedule	Word	R/W
7CD5H~7CD7H	31957~31959	The 4th holiday and schedule	Word	R/W
7CD8H~7CDAH	31960~31962	The 5th holiday and schedule	Word	R/W
7CDBH~7CDDH	31963~31965	The 6th holiday and schedule	Word	R/W
7CDEH~7CE0H	31966~31968	The 7th holiday and schedule	Word	R/W
7CE1H~7CE3H	31969~31971	The 8th holiday and schedule	Word	R/W
7CD4H~7CE6H	31972~31974	The 9th holiday and schedule	Word	R/W
7CE7H~7CE9H	31975~31977	The 10th holiday and schedule	Word	R/W
7CEAH~7CECH	31978~31980	The 11th holiday and schedule	Word	R/W
7CEDH~7CEFH	31981~31983	The 12th holiday and schedule	Word	R/W
7CF0H~7CF2H	31984~31986	The 13th holiday and schedule	Word	R/W
7CF3H~7CF5H	31987~31989	The 14th holiday and schedule	Word	R/W
7CF6H~7CF8H	31990~31992	The 15th holiday and schedule	Word	R/W
7CF9H~7CFBH	31993~31995	The 16th holiday and schedule	Word	R/W
7CFCH~7CFEH	31996~31998	The 17th holiday and schedule	Word	R/W
7CFFH~7D01H	31999~32001	The 18th holiday and schedule	Word	R/W
7D02H~7D04H	32002~32004	The 19th holiday and schedule	Word	R/W
7D05H~7D07H	32005~32007	The 20th holiday and schedule	Word	R/W
7D08H~7D0AH	32008~32010	The 21st holiday and schedule	Word	R/W
7DOBH~7D0DH	32011~32013	The 22nd holiday and schedule	Word	R/W
7D0EH~7D10H	32014~32016	The 23rd holiday and schedule	Word	R/W
7D11H~7D13H	32017~32019	The 24th holiday and schedule	Word	R/W
7D14H~7D16H	32020~32022	The 25th holiday and schedule	Word	R/W
7D17H~7D19H	32023~32025	The 26th holiday and schedule	Word	R/W
7D1AH~7D1CH	32026~32028	The 27th holiday and schedule	Word	R/W
7D1DH~7D1FH	32029~32031	The 28th holiday and schedule	Word	R/W
7D20H~7D22H	32032~32034	The 29th holiday and schedule	Word	R/W

The 6th Year Holiday Address Function: 03H Read 10H Preset				
Address(H)	Address(D)	Parameters	Data Type	Type of Access
7D23H~7D25H	32035~32037	The 30th holiday and schedule	Word	R/W
7D26H	32038	The 6th setting year	Word	R/W
7D27H	32039	Holiday number of the 6th year	Word	R/W

Table 6-72

The 7th Year Holiday Address Function: 03H Read 10H Preset				
Address(H)	Address(D)	Parameters	Data Type	Type of Access
7D28H~7D2AH	32040~32042	The 1st holiday and schedule (format: month/day/schedule)	Word	R/W
7D2BH~7D2DH	32043~32045	The 2nd holiday and schedule	Word	R/W
7D2EH~7D30H	32046~32048	The 3rd holiday and schedule	Word	R/W
7D31H~7D33H	32049~32051	The 4th holiday and schedule	Word	R/W
7D34H~7D36H	32052~32054	The 5th holiday and schedule	Word	R/W
7D37H~7D39H	32055~32057	The 6th holiday and schedule	Word	R/W
7D3AH~7D3CH	32058~32060	The 7th holiday and schedule	Word	R/W
7D3DH~7D3FH	32061~32063	The 8th holiday and schedule	Word	R/W
7D40H~7D42H	32064~32066	The 9th holiday and schedule	Word	R/W
7D43H~7D45H	32067~32069	The 10th holiday and schedule	Word	R/W
7D46H~7D48H	32070~32072	The 11th holiday and schedule	Word	R/W
7D49H~7D4BH	32073~32075	The 12th holiday and schedule	Word	R/W
7D4CH~7D4EH	32076~32078	The 13th holiday and schedule	Word	R/W
7D4FH~7D51H	32079~32081	The 14th holiday and schedule	Word	R/W
7D52H~7D54H	32082~32084	The 15th holiday and schedule	Word	R/W
7D55H~7D57H	32085~32087	The 16th holiday and schedule	Word	R/W
7D58H~7D5AH	32088~32090	The 17th holiday and schedule	Word	R/W
7D5BH~7D5DH	32091~32093	The 18th holiday and schedule	Word	R/W
7DFEH~7D60H	32094~32096	The 19th holiday and schedule	Word	R/W
7D61H~7D63H	32097~32099	The 20th holiday and schedule	Word	R/W
7D64H~7D66H	32100~32102	The 21st holiday and schedule	Word	R/W
7D67H~7D69H	32103~32105	The 22nd holiday and schedule	Word	R/W

The 7th Year Holiday Address Function: 03H Read 10H Preset				
Address(H)	Address(D)	Parameters	Data Type	Type of Access
7D6AH~7D6CH	32106~32108	The 23rd holiday and schedule	Word	R/W
7D6DH~7D6FH	32109~32111	The 24th holiday and schedule	Word	R/W
7D70H~7D72H	32112~32117	The 25th holiday and schedule	Word	R/W
7D73H~7D75H	32115~32117	The 26th holiday and schedule	Word	R/W
7D76H~7D78H	32118~32120	The 27th holiday and schedule	Word	R/W
7D79H~7D7BH	32121~32123	The 28th holiday and schedule	Word	R/W
7D7CH~7D7EH	32124~32126	The 29th holiday and schedule	Word	R/W
7D7FH~7D81H	32127~32129	The 30th holiday and schedule	Word	R/W
7D82H	32130	The 7th setting year	Word	R/W
7D83H	32131	Holiday number of the 7th year	Word	R/W

Table 6-73

The 8th Year Holiday Address Function: 03H Read 10H Preset				
Address(H)	Address(D)	Parameters	Data Type	Type of Access
7D84H~7D86H	32132~32134	The 1st holiday and schedule (format: month/day/schedule)	Word	R/W
7D87H~7D89H	32135~32137	The 2nd holiday and schedule	Word	R/W
7D8AH~7D8CH	32138~32140	The 3rd holiday and schedule	Word	R/W
7D8DH~7D8FH	32141~32143	The 4th holiday and schedule	Word	R/W
7D90H~7D92H	32144~32146	The 5th holiday and schedule	Word	R/W
7D93H~7D95H	32147~32149	The 6th holiday and schedule	Word	R/W
7D96H~7D98H	32150~32152	The 7th holiday and schedule	Word	R/W
7D99H~7D9BH	32153~32155	The 8th holiday and schedule	Word	R/W
7D9CH~7D9EH	32156~32158	The 9th holiday and schedule	Word	R/W
7D9FH~7DA1H	32159~32161	The 10th holiday and schedule	Word	R/W
7DA2H~7DA4H	32162~32164	The 11th holiday and schedule	Word	R/W
7DA5H~7DA7H	32165~32167	The 12th holiday and schedule	Word	R/W
7DA8H~7DAAH	32168~32170	The 13th holiday and schedule	Word	R/W
7DABH~7DADH	32171~32173	The 14th holiday and schedule	Word	R/W
7DAEH~7DB0H	32174~32176	The 15th holiday and schedule	Word	R/W

The 8th Year Holiday Address Function: 03H Read 10H Preset				
Address(H)	Address(D)	Parameters	Data Type	Type of Access
7DB1H~7DB3H	32177~32179	The 16th holiday and schedule	Word	R/W
7DB4H~7DB6H	32180~32182	The 17th holiday and schedule	Word	R/W
7DB7H~7DB9H	32183~32185	The 18th holiday and schedule	Word	R/W
7DBAH~7DBCH	32186~32188	The 19th holiday and schedule	Word	R/W
7DBDH~7DBFH	32189~32191	The 20th holiday and schedule	Word	R/W
7DC0H~7DC2H	32192~32194	The 21st holiday and schedule	Word	R/W
7DC3H~7DC5H	32195~32197	The 22nd holiday and schedule	Word	R/W
7DC6H~7DC8H	32198~32200	The 23rd holiday and schedule	Word	R/W
7DC9H~7DCBH	32201~32203	The 24th holiday and schedule	Word	R/W
7DCCH~7DCEH	32204~32206	The 25th holiday and schedule	Word	R/W
7DCFH~7DD1H	32207~32209	The 26th holiday and schedule	Word	R/W
7DD2H~7DD4H	32210~32212	The 27th holiday and schedule	Word	R/W
7DD5H~7DD7H	32213~32215	The 28th holiday and schedule	Word	R/W
7DD8H~7DDAH	32216~32218	The 29th holiday and schedule	Word	R/W
7DDBH~7DDDH	32219~32221	The 30th holiday and schedule	Word	R/W
7DDEH	32222	The 8th setting year	Word	R/W
7DDFH	32223	Holiday number of the 8th year	Word	R/W

Table 6-74

The 9th Year Holiday Address Function: 03H Read 10H Preset				
Address(H)	Address(D)	Parameters	Data Type	Type of Access
7DE0H~7DE2H	32224~32226	The 1st holiday and schedule (format: month/day/schedule)	Word	R/W
7DE3H~7DE5H	32227~32229	The 2nd holiday and schedule	Word	R/W
7DE6H~7DE8H	32230~32232	The 3rd holiday and schedule	Word	R/W
7DE9H~7DEBH	32233~32235	The 4th holiday and schedule	Word	R/W
7DECH~7DEEH	32236~32238	The 5th holiday and schedule	Word	R/W
7DEFH~7DF1H	32239~32241	The 6th holiday and schedule	Word	R/W
7DF2H~7DF4H	32242~32244	The 7th holiday and schedule	Word	R/W
7DF5H~7DF7H	32245~32247	The 8th holiday and schedule	Word	R/W

The 9th Year Holiday Address Function: 03H Read 10H Preset				
Address(H)	Address(D)	Parameters	Data Type	Type of Access
7DF8H~7DFAH	32248~32250	The 9th holiday and schedule	Word	R/W
7DFBH~7DFDH	32251~32253	The 10th holiday and schedule	Word	R/W
7DFEH~7E00H	32254~32256	The 11th holiday and schedule	Word	R/W
7E01H~7E03H	32257~32259	The 12th holiday and schedule	Word	R/W
7E04H~7E06H	32260~32262	The 13th holiday and schedule	Word	R/W
7E07H~7E09H	32263~32265	The 14th holiday and schedule	Word	R/W
7E0AH~7E0CH	32266~32268	The 15th holiday and schedule	Word	R/W
7E0DH~7E0FH	32269~32271	The 16th holiday and schedule	Word	R/W
7E10H~7E12H	32272~32274	The 17th holiday and schedule	Word	R/W
7E13H~7E15H	32275~32277	The 18th holiday and schedule	Word	R/W
7E16H~7E18H	32278~32280	The 19th holiday and schedule	Word	R/W
7E19H~7E1BH	32281~32283	The 20th holiday and schedule	Word	R/W
7E1CH~7E1EH	32284~32286	The 21st holiday and schedule	Word	R/W
7E1FH~7E21H	32287~32289	The 22nd holiday and schedule	Word	R/W
7E22H~7E24H	32290~32292	The 23rd holiday and schedule	Word	R/W
7E25H~7E27H	32293~32295	The 24th holiday and schedule	Word	R/W
7E28H~7E2AH	32296~32298	The 25th holiday and schedule	Word	R/W
7E2BH~7E2DH	32299~32301	The 26th holiday and schedule	Word	R/W
7E2EH~7E30H	32302~32304	The 27th holiday and schedule	Word	R/W
7E31H~7E33H	32305~32307	The 28th holiday and schedule	Word	R/W
7E34H~7E36H	32308~32310	The 29th holiday and schedule	Word	R/W
7E37H~7E39H	32311~32313	The 30th holiday and schedule	Word	R/W
7E3AH	32314	The 9th setting year	Word	R/W
7E3BH	32315	Holiday number of the 9th year	Word	R/W

Table 6-75

The 10th Year Holiday Address Function: 03H Read 10H Preset				
Address(H)	Address(D)	Parameters	Data Type	Type of Access
7E3CH~7E3EH	32316~32318	The 1st holiday and schedule (format: month/day/schedule)	Word	R/W
7E3FH~7E41H	32319~32321	The 2nd holiday and schedule	Word	R/W

The 10th Year Holiday Address Function: 03H Read 10H Preset				
Address(H)	Address(D)	Parameters	Data Type	Type of Access
7E42H~7E44H	32322~32324	The 3rd holiday and schedule	Word	R/W
7E45H~7E47H	32325~32327	The 4th holiday and schedule	Word	R/W
7E48H~7E4AH	32328~32330	The 5th holiday and schedule	Word	R/W
7E4BH~7E4DH	32331~32333	The 6th holiday and schedule	Word	R/W
7E4EH~7E50H	32334~32336	The 7th holiday and schedule	Word	R/W
7E51H~7E53H	32337~32339	The 8th holiday and schedule	Word	R/W
7E54H~7E56H	32340~32342	The 9th holiday and schedule	Word	R/W
7E57H~7E59H	32343~32345	The 10th holiday and schedule	Word	R/W
7E5AH~7E5CH	32346~32348	The 11th holiday and schedule	Word	R/W
7E5DH~7E5FH	32349~32351	The 12th holiday and schedule	Word	R/W
7E60H~7E62H	32352~32354	The 13th holiday and schedule	Word	R/W
7E63H~7E65H	32355~32357	The 14th holiday and schedule	Word	R/W
7E66H~7E68H	32358~32360	The 15th holiday and schedule	Word	R/W
7E69H~7E6BH	32361~32363	The 16th holiday and schedule	Word	R/W
7E6CH~7E6EH	32364~32366	The 17th holiday and schedule	Word	R/W
7E6FH~7E71H	32367~32369	The 18th holiday and schedule	Word	R/W
7E72H~7E74H	32370~32372	The 19th holiday and schedule	Word	R/W
7E75H~7E77H	32373~32375	The 20th holiday and schedule	Word	R/W
7E78H~7E7AH	32376~32378	The 21st holiday and schedule	Word	R/W
7E7BH~7E7DH	32379~32381	The 22nd holiday and schedule	Word	R/W
7E7EH~7E80H	32382~32384	The 23rd holiday and schedule	Word	R/W
7E81H~7E83H	32385~32387	The 24th holiday and schedule	Word	R/W
7E84H~7E86H	32388~32390	The 25th holiday and schedule	Word	R/W
7E87H~7E89H	32391~32393	The 26th holiday and schedule	Word	R/W
7E8AH~7E8CH	32394~32396	The 27th holiday and schedule	Word	R/W
7E8DH~7E8FH	32397~32399	The 28th holiday and schedule	Word	R/W
7E90H~7E92H	32400~32402	The 29th holiday and schedule	Word	R/W
7E93H~7E95H	32403~32405	The 30th holiday and schedule	Word	R/W
7E96H	32406	The 10th setting year	Word	R/W
7E97H	32407	Holiday number of the 10th year	Word	R/W

Table 6-76

Address(H)	Address(H)	Parameters	Data Type	Property	Range	Default	Factory Setting
8000H	32768	Manual triggering waveform	Word	R/W	0xAA: Enable 0: Disable	0	0
8001H	32769	D1 triggering – AXM-11	Word	R/W	bit1bit0: DI1, bit3bit2: DI2, bit5bit4: DI3, bit7bit6: DI4, bit9bit8: DI5, bit11bit10: DI6, 00: Disable; 00: From OFF to ON; 10: From ON to OFF; 11: Any DI state change	0	0
8002H	32770	DI triggering – AXM-21	Word	R/W	bit1bit0: DI7, bit3bit2: DI8, bit5bit4: DI9, bit7bit6: DI10; The same as above	0	0
8003H	32771	DI triggering – AXM-31	Word	R/W	Bit1bit0: DI11, bit3bit2: DI12, bit5bit4: DI13, bit7bit6: DI14; The same as above	0	0
8004H	32772	Voltage rated value	Word	R/W	50V-400V or 50V-690V (only in 3LL)	400	400
8005H	32773	Voltage sag triggering waveform	Word	R/W	1: Enable, 0: Disable	0	0
8006H	32774	Voltage sag threshold	Word	R/W	20-100%	10	10
8007H	32775	Voltage sag half cycle threshold	Word	R/W	4-200 half cycles	0	0
8008H	32776	Voltage swell triggering threshold	Word	R/W	1: Enable, 0: Disable	100	100
8009H	32777	Voltage swell threshold	Word	R/W	50-140%		
800AH	32778	Reserved	Word	R/W		5000	5000
800BH	32779	Current rated value	Word	R/W	1: Enable, 0: Disable		
800CH	32780	Over-current triggering waveform	Word	R/W	1: Enable, 0: Disable	0	0
800DH	32781	Over-current threshold	Word	R/W	50-150%	100	100
800EH	32782	Clear waveform	Word	R/W	0x55 enable	0	0
800FH	32783	Clear power quality event	Word	R/W	0x55 enable	0	0

NOTE: In 3LL and 2LL, voltage rated value is line voltage; in 3LN, 1LN and 1LL, voltage rated value is phase voltage.

Waveform Capture Data Retrieve Address

Waveform Capture includes timestamp, triggering condition, and waveform data. Every group uses

the same data format. Only one group of waveforms is saved in the registers. When retrieving the waveform, first write 1-8 group number into 0X801FH, then read the registers after it to acquire the waveform corresponding to the written group number.

The relationship between voltage waveform value and real value:

$$\text{Real Value (Unit: V)} = \text{Waveform Value} / 37.59105$$

The relationship between current waveform value and real value:

1. 5A, 1A: Real Value (Unit: A) = Waveform Value/1683.153;
2. 333mV: Real Value (Unit: A) = Waveform Value/K (firmware above 3.21,K=14427.15; other: K = 15869.87);
3. 100mV(Rope-CT): Real Value(Unit: A) = Waveform Value/K (firmware above 3.21,K=20291.1; firmware 3.20, K=22068.8,other: K = 15869.87);
4. mA CT: Real Value(Unit: A) = Waveform Value/K (80mA CT: K=7414.289; 100mA: K=9267.440; 200mA: K=18514.68);

The voltage and current value obtained from the waveform are the PT or CT secondary side value.

Read: 03, Preset: 10. For more information, please refer to Chapter 4.7.

Table 6-77

Address (H)	Address (D)	Parameter	Default	Range	Data Type	Property
8E00H	36352	Waveform group number for retrieving		1~100 When the value is smaller than or equal to newest waveform record group number, this value is valid	Word	R/W
8E01H	36353	Waveform group number		Waveform number 0-121	Word	R/W
8E02H	36354	Waveform record window status		0x0BH: Window data is valid 0xFF: Window data is invalid 0xAA: Waveform record memory is clearing (data is invalid)	Word	R/W
8E03H	36355	Newest waveform group number		1~100 0: No record	Word	R/W
8E04H~8E43	36356~36419	Waveform record data retrieving window		-32768~32767	Word	R/W

Power Quality Event Retrieve Address

Power quality event includes timestamp, triggering condition, and related settings. Every group uses the same data format. Only 10 groups of data are saved in the registers. When retrieving the event data, its parameters must be correctly set in order to get correct information.

Read: FC03, Preset: FC16. For more information, please refer to Chapter 4.7.

Table 6-78

Address(H)	Address(H)	Parameters	Data Type	Property	Range	Default	Factory Setting
8CFDH	36093	Newest event group number	Word	R	1-50000 0: No data	0	0
8CFEH	36094	Event for retrieving starting byte group number	Word	R/W	1-50000 Only valid smaller or equal to newest event group number	1	1
No. 1 Event							
8D00H	36096	Timestamp High byte – Year Low byte – Month	Word	R	Time		
8D01H	36097	Timestamp High byte – Day Low byte – Hour	Word	R	Time		
8D02H	36098	Timestamp High byte – Minute Low byte – Second	Word	R	Time		
8D03H	36099	Timestamp: Millisecond	Word	R	Time		
8D04H	36100	Voltage sag or voltage swell condition	Word	R	0: Disabled, 1: Voltage sag, 2: Voltage swell		
8D05H	36101	Rated value	Word	R	50V~400V or 50V~690V (only in 3LL)		
8D06H	36102	Threshold	Word	R	Voltage sag: 20-100%, Voltage swell: 50-140%		
8D07H	36103	Half cycle count	Word	R	Voltage sag event: 4~200; Voltage swell event: 0		
8D08H~8D0FH	36104~36111	No. 2 Event	Word	R			
8D10H~8D17H	36112~36119	No. 3 Event	Word	R			
8D18H~8D1FH	36120~36127	No. 4 Event	Word	R			

Acuvim II Series Power Meter

Address(H)	Address(H)	Parameters	Data Type	Property	Range	Default	Factory Setting
8D20H~ 8D27H	36128~ 36135	No. 5 Event	Word	R			
8D28H~ 8D2FH	36136~ 36143	No. 6 Event	Word	R			
8D30H~ 8D37H	36144~ 36151	No. 7 Event	Word	R			
8D38H~ 8D3FH	36152~ 36159	No. 8 Event	Word	R			
8D40H~ 8D47H	36160~ 36167	No. 9 Event	Word	R			
8D48H~ 8D4FH	36168~ 36175	No. 10 Event	Word	R			

Appendix

Appendix A Technical Data and Specification

Input Ratings

CURRENT INPUTS (EACH CHANNEL)

Nominal Current Options	① 5A, ② 1A, ③ 1A (333mV) ④ 1A (100mV Rope CT) ⑤ 1A (80mA/100mA/200mA)
Metering Range	① 0-10A, ② 0-2A, ③ 0-1.2A, ④ 0-1.2A, ⑤ 0-1.2A
Pickup Current	① 5mA, ② 1mA, ③ 5mA, ④ 5mA, ⑤ 5mA
Withstand	20Arms Continuous, 0.1% of Nominal 100Arms for 1 second, Non-Recurring
Burden	0.05VA (Typical) @ 5A RMS
Accuracy	0.1% at Reading

VOLTAGE INPUTS (EACH CHANNEL)

Nominal Full Scale	400Vac L-N, 690Vac L-L (+20%)
Withstand	1500Vac Continuous 2500Vac, 50/60Hz for 1 Minute
Input Impedance	2M Ω per Phase
Metering Frequency	45Hz~65Hz, 300Hz~500Hz
Pickup Voltage	10Vac
Accuracy	0.1% at Reading

ENERGY ACCURACY

Active	Class 0.1s (According to IEC 62053-22) Class 0.1 (According to ANSI C12.20)
Reactive	Class 2 (According to IEC 62053-23)

HARMONIC RESOLUTION

Metered Value	63rd Harmonic (50Hz or 60Hz type) 15th Harmonic (400Hz type)
---------------	-----------------------------------------------------------------

Acuvim II Series Power Meter

Metering

PARAMETERS		ACCURACY	RESOLUTION	RANGE
Voltage		0.1%	0.1V	10V~1000kV
Current		0.1%	0.1mA	5mA~50000A
Power		0.1%	1W	-9999MW~9999MW
Reactive Power		0.1%	1var	-9999Mvar~9999Mvar
Apparent Power		0.1%	1VA	0~9999MVA
Power Demand		0.1%	1W	-9999MW~9999MW
Reactive Power Demand		0.1%	1var	-9999Mvar~9999Mvar
Apparent Power Demand		0.1%	1VA	0~9999MVA
Power Factor		0.1%	0.001	-1.000~1.000
Frequency		0.001%	0.001Hz	45.00~65.00Hz (50 or 60Hz type) 300.00Hz~500.00Hz (400Hz type)
Energy	Primary	0.1%	0.1kWh	0-99999999.9kWh
	Secondary	0.1%	0.001kWh	0-999999.999kWh
Reactive Energy	Primary	0.1%	0.1kvarh	0-99999999.9kvarh
	Secondary	0.1%	0.001kvarh	0-999999.999kvarh
Apparent Energy	Primary	0.1%	0.1kVAh	0-99999999.9kVAh
	Secondary	0.1%	0.001kVAh	0-999999.999kVAh
Harmonics		1.0%	0.1%	
Phase Angle		2.0%	0.1°	0.0°~359.9°
Unbalance Factor Stay The Same		2.0%	0.1%	0.0%~100.0%
Running Time			0.01h	0~9999999.99h

Control Power

Universal AC or DC

AC/DC CONTROL POWER

Operating Range	100~415Vac, 50/60Hz; 100~300Vdc
Burden	5W
Frequency	50/60Hz
Withstand	3250Vac, 50/60Hz for 1 minute Installation Category III (Distribution)

LOW VOLTAGE DC CONTROL POWER (OPTIONAL)

Operating Range	20~60Vdc
Burden	5W

I/O Options

DIGITAL INPUT

Input Type	Dry
Input Resistance	100k Ω
Input Voltage Range	20–160 Vac/dc
Input Current (Max)	2mA
Start Voltage	15V
Stop Voltage	5V
Pulse Frequency (Max)	100Hz, 50% Duty Ratio (5ms ON and 5ms OFF)
SOE Resolution	2ms

DIGITAL OUTPUT (DO) (PHOTO-MOS)

Voltage Range	0–250Vac/dc
Load Current	100mA (Max)
Output Frequency	25Hz, 50% Duty Ratio (20ms ON, 20ms OFF)
Isolation Voltage	2500Vac

RELAY OUTPUT (RO) (NO, Form A)

Switching Voltage (Max)	250Vac, 30Vdc
Load Current	5A(R), 2A(L)
Set Time	10ms (Max)
Contact Resistance	30m Ω (Max)
Isolation Voltage	2500Vac
Mechanical Life	1.5x10 ⁷

ANALOGUE OUTPUT (AO)

Output Range	0–5V, 0–20mA; 1–5V, 4–20mA; Optional
Accuracy	0.50%
Temperature Drift	50ppm/ $^{\circ}$ C Typical
Isolation Voltage	500Vdc
Open Circuit Voltage	15V

ANALOGUE INPUT (AI)

Input Range	0–5V, 0–20mA; 1–5V, 4–20mA; Optional
Accuracy	0.20%
Temperature Drift	50ppm/ $^{\circ}$ C Typical
Isolation Voltage	500Vdc

POWER SUPPLY FOR DI (24 VDC)

Output Voltage	24Vdc
Output Current	42mA
Load (Max)	21 Dis

Standard Compliance & Certifications

Measurement Standard	IEC 62053-22; ANSI C12.20; IEC61557-12
Environmental Standard	IEC 60068-2, CE, RoHS
Safety Standard	IEC 61010-1, UL 61010-1
EMC Standard	IEC 61000-4/-2-3-4-5-6-8-11, CISPR 22, IEC 61000-3-2, IEC 61000-6-2/4
Outlines Standard	DIN 43700, ANSI C39.1
Protocol Conformance	IEC 61850 2nd Edition BTL Listed for B-SA (Acuvim IIR, IIW)

Communications

Modbus-RTU or BACnet MS/TP	Modbus-RTU 2-Wire Shielded Twisted Pair Cable Connection 1200~115200 bps
---------------------------------------	--------------------------------------------------------------------------------

SECOND RS-485 PORT (OPTIONAL MODULE)	Same as the primary RS485 port Baud Rate: 4800~38400 bps
-------------------------------------------------	-------------------------------------------------------------

ETHERNET (OPTIONAL MODULE)	Ethernet 10M/100M BaseT MODBUS-TCP/IP DNP 3.0 Over IP Level 2 IEC 61850 2nd Edition SNMP V3 BACnet-IP HTTP/HTTPs Webserver HTTP/HTTPs, FTP data post SMTP MQTT MV90 NTP
---------------------------------------	----------------------------------------------------------------------------------------------------------------------------------------------------------------------------------------------------------

PROFIBUS (OPTIONAL MODULE)	PROFIBUS-DP/V0 Protocol Work as PROFIBUS Slave, Baud Rate Adaptive, up to 12M Model 1: Input Bytes: 32, Output Bytes: 32 Model 2: Input Bytes: 64, Output Bytes: 2 PROFIBUS Standard According to EN 50170 Vol. 2
---------------------------------------	----------------------------------------------------------------------------------------------------------------------------------------------------------------------------------------------------------------------------------

Control Power

Universal	AC or DC
-----------	----------

AC/DC CONTROL POWER

Operating Range	100~415Vac, 50/60Hz; 100~300Vdc
-----------------	---------------------------------

Burden	5W
--------	----

Frequency	50/60Hz
-----------	---------

Withstand	3250Vac, 50/60Hz for 1 minute
-----------	-------------------------------

	Installation Category III (Distribution)
--	------------------------------------------

LOW VOLTAGE DC CONTROL POWER (OPTIONAL)

Operating Range	20~60Vdc
-----------------	----------

Burden	5W
--------	----

Operating Environment

Operating Temperature	-25°C to 70°C
	-13°F to 158°F

Storage Temperature	-40°C to 85°C
	-40°F to 176°F

Relative Humidity	5% to 95% Non-Condensing
-------------------	--------------------------

Appendix B Ordering Information

Meter Model	Mounting Option	Current Input	Power Supply
Acuvim IIR: Data Logging, TOU	D: LCD Display (Panel Mount Meter/ Transducer)	5A: 5A/1A (Input Field Selectable)	P1V3: 100~415Vac, 50/60Hz, 100~300Vdc
Acuvim IIW: IIR + Waveform Capture and PQ Event Logging	M: DIN-Rail Mount Transducer without Display (Optional Remote Display Available)	mV: 333mV and Rogowski Coil (Input Field Selectable) mA: 80ma/100mA/200mA (Input Field Selectable)	P2V3: 20~60Vdc

Ordering Example: Acuvim IIR-D-5A-P1V3

- Note:
1. Accuenergy suggests using USB-RS485 converter for configuration, and 3 CTs per three phase circuits.
 2. All fields must be completed to create a part number.
 3. Add "-S" after power supply for anti-tampering seal option.
 4. Contact Accuenergy for 400Hz frequency option; Acuvim IIW doesn't support this type.

Communication Module (Optional)	Protocols
AXM	WEB2-FOLC: IEC 61850, Modbus-TCP, HTTP/HTTPS Webserver, SMTP Email, SNMP, HTTP/HTTPS Push, FTP Post, sFTP Server, BACnet-IP, Datalogging, WiFi, Fiber Optics LC
	WEB2: IEC 61850, Modbus-TCP, HTTP/HTTPS Webserver, SMTP Email, SNMP, HTTP/HTTPS Push, FTP Post, sFTP Server, BACnet-IP, Datalogging, WiFi
	WEB-PUSH: Modbus-TCP, HTTP/HTTPS Webserver, SMTP Email, SNMP, HTTP/HTTPS Push, FTP Post, sFTP Server, Datalogging
	PROFI: PROFIBUS
	RS485: Modbus-RTU
	MESH-900: Wireless Radio (900MHz)
	MESH-868: Wireless Radio (868MHz)

Ordering Example: AXM-RS485

I/O Module (Optional)	- Logic Module	- Input/Output Type
AXM-IO1	1	
	2	
Ordering Example:	AXM-IO1-1	
AXM-IO2	1	A: 4~20mA
AXM-IO3	2	B: 0~20mA
		C: 1~5V
		D: 0~5V
Ordering Example:	AXM-IO3-1B	

Accessories (Optional)

REM-DS2:	Remote Display (Only for Acuvim II DIN-Rail Mount "M" option)
AXM-DIN:	DIN Rail Adapter
IP66/NEMA4X:	Environmental Protection Cover
USB-RS485:	USB-to-RS485 Converter

Ordering Example: **AXM-DIN**

- Note:
1. Refer to the Communication table and Digital/Analogue I/O table on page 6.
 2. A maximum of 3 modules may be attached to the meter. If a communication module is used (e.g. AXM-WEB2), it must be installed on the back FIRST before the other I/O modules are attached.
 3. No more than 2 of the same I/O modules may be attached to the meter (e.g. two AXM-IO2). The same two I/O modules must have a different logic number.
 4. If Acuvim IIW uses DI to trigger a waveform capture, the I/O module logic number must be Module 1.



MAKE ENERGY USAGE SMARTER

ACCUENERGY (CANADA) INC.

22 Howden Rd
Scarborough, ON M1R 3E4, Canada

TF: 1-877-721-8908
INT: +1-416-497-4100
FAX: +1-416-497-4130
E: marketing@accuenergy.com

ACCUENERGY SOUTH AFRICA (PTY) LTD

Castle Walk Corporate Park,
Block B, Cnr. Nossob & Swakop Street
Erasmuskloof, Pretoria, 0181
South Africa

TF: +27 (0) 87 802 6136



Revision Date: November 2022