



### ■ Features :

- Universal AC input / Full range (up to 305VAC)
- Built-in active PFC function
- High efficiency up to 95%
- Protections: Short circuit / Over current / Over voltage / Over temperature
- Cooling by free air convection
- OCP point adjustable through output cable or internal potentiometer
- IP67 / IP65 design for indoor or outdoor installations
- Three in one dimming function (1~10Vdc or PWM signal or resistance)
- Suitable for LED lighting and street lighting applications
- Compliance to worldwide safety regulations for lighting
- Suitable for dry / damp / wet location
- 5 years warranty (Note.10)



HLG-320H-12 **A** Blank : IP67 rated. Cable for I/O connection.  
**A** : IP65 rated. Output voltage and constant current level can be adjusted through internal potentiometer.  
**B** : IP67 rated. Constant current level adjustable through output cable with 1~10Vdc or PWM signal or resistance.  
**C** : Terminal block for I/O connection. Output voltage and constant current level can be adjusted through internal potentiometer.  
**D** (option) : IP67 rated. Timer dimming function, contact MEAN WELL for details.

### SPECIFICATION

| MODEL                   | HLG-320H-12  | HLG-320H-15  | HLG-320H-20 | HLG-320H-24    | HLG-320H-30 | HLG-320H-36    | HLG-320H-42 | HLG-320H-48 | HLG-320H-54 |            |  |
|-------------------------|--|--|-------------|----------------|-------------|----------------|-------------|-------------|-------------|------------|--|
| OUTPUT                  | DC VOLTAGE   | 12V  | 15V         | 20V            | 24V         | 30V            | 36V         | 42V         | 48V         | 54V        |  |
|                         | CONSTANT CURRENT REGION Note.4   | 6~12V  | 7.5~15V     | 10~20V         | 12~24V      | 15~30V         | 18~36V      | 21~42V      | 24~48V      | 27~54V     |  |
|                         | RATED CURRENT  | 22A  | 19A         | 15A            | 13.34A      | 10.7A          | 8.9A        | 7.65A       | 6.7A        | 5.95A      |  |
|                         | RATED POWER  | 264W   | 285W        | 300W           | 320.16W     | 321W           | 320.4W      | 321.3W      | 321.6W      | 321.3W     |  |
|                         | RIPPLE & NOISE (max.) Note.2   | 150mVp-p   | 150mVp-p    | 150mVp-p       | 150mVp-p    | 200mVp-p       | 250mVp-p    | 250mVp-p    | 250mVp-p    | 350mVp-p   |  |
|                         | VOLTAGE ADJ. RANGE Note.6  | 10.8~13.5V   | 13.5~17V    | 17~22V         | 21~26V      | 26~32V         | 32~39V      | 38~45V      | 43~52V      | 49~58V     |  |
|                         | CURRENT ADJ. RANGE   | Can be adjusted by internal potentiometer A type and C type only   |             |                |             |                |             |             |             |            |  |
|                         |  | 11~22A   | 9.5~19A     | 7.5~15A        | 6.67~13.34A | 5.35~10.7A     | 4.45~8.9A   | 3.8~7.65A   | 3.35~6.7A   | 2.97~5.95A |  |
|                         | VOLTAGE TOLERANCE Note.3   | ±3.0%  | ±2.0%       | ±1.5%          | ±1.0%       | ±1.0%          | ±1.0%       | ±1.0%       | ±1.0%       | ±1.0%      |  |
|                         | LINE REGULATION  | ±0.5%  | ±0.5%       | ±0.5%          | ±0.5%       | ±0.5%          | ±0.5%       | ±0.5%       | ±0.5%       | ±0.5%      |  |
| LOAD REGULATION         | ±2.0%  | ±1.5%  | ±1.0%       | ±0.5%          | ±0.5%       | ±0.5%          | ±0.5%       | ±0.5%       | ±0.5%       |            |  |
| SETUP, RISE TIME Note.8 | 2500ms, 80ms at full load 230VAC /115VAC   |  |             |                |             |                |             |             |             |            |  |
| HOLD UP TIME (Typ.)     | 15ms at full load 230VAC /115VAC   |  |             |                |             |                |             |             |             |            |  |
| INPUT                   | VOLTAGE RANGE Note.5   | 90~305VAC  |             | 127~431VDC     |             |                |             |             |             |            |  |
|                         | FREQUENCY RANGE  | 47~63Hz  |             |                |             |                |             |             |             |            |  |
|                         | POWER FACTOR (Typ.)  | PF>0.98/115VAC, PF>0.95/230VAC, PF>0.94/277VAC at full load (Please refer to "Power Factor Characteristic" curve)                              |             |                |             |                |             |             |             |            |  |
|                         | TOTAL HARMONIC DISTORTION  | THD<20% when output loading ≥ 50% at 115VAC/230VAC input and output loading ≥ 75% at 277VAC input  |             |                |             |                |             |             |             |            |  |
|                         | EFFICIENCY (Typ.) (230Vac)   | 91%  | 92.5%       | 93.5%          | 94%         | 94%            | 94.5%       | 95%         | 95%         | 95%        |  |
|                         | EFFICIENCY (Typ.) (277Vac)   | 91.5%  | 93%         | 94%            | 94.5%       | 94.5%          | 95%         | 95%         | 95%         | 95%        |  |
|                         | AC CURRENT (Typ.)  | 3.5A / 115VAC  |             | 1.65A / 230VAC |             | 1.45A / 277VAC |             |             |             |            |  |
|                         | INRUSH CURRENT (Typ.)  | COLD START 70A(twidth=1010μs measured at 50% Ipeak) at 230VAC  |             |                |             |                |             |             |             |            |  |
| LEAKAGE CURRENT         | <0.75mA / 277VAC   |  |             |                |             |                |             |             |             |            |  |
| PROTECTION              | OVER CURRENT Note.4  | 95~108%<br>Protection type : Constant current limiting, recovers automatically after fault condition is removed                                |             |                |             |                |             |             |             |            |  |
|                         | SHORT CIRCUIT  | Hiccup mode, recovers automatically after fault condition is removed.  |             |                |             |                |             |             |             |            |  |
|                         | OVER VOLTAGE   | 14~17V   | 17.5~21V    | 22.5~27V       | 27~33V      | 33~37V         | 40~46V      | 46.5~53V    | 53.5~60V    | 59~65V     |  |
|                         | OVER TEMPERATURE   | 100°C ±10°C (RTH2)<br>Protection type : Shut down and latch off o/p voltage, re-power on to recover  |             |                |             |                |             |             |             |            |  |
| ENVIRONMENT             | WORKING TEMP.  | -40~+70°C (Refer to "Derating Curve")  |             |                |             |                |             |             |             |            |  |
|                         | WORKING HUMIDITY   | 20~95% RH non-condensing   |             |                |             |                |             |             |             |            |  |
|                         | STORAGE TEMP., HUMIDITY  | -40~+80°C, 10~95% RH   |             |                |             |                |             |             |             |            |  |
|                         | TEMP. COEFFICIENT  | ±0.03%/°C (0~50°C)   |             |                |             |                |             |             |             |            |  |
|                         | VIBRATION  | 10~500Hz, 5G 12min./1cycle, period for 72min. each along X, Y, Z axes  |             |                |             |                |             |             |             |            |  |
| SAFETY & EMC            | SAFETY STANDARDS Note.7  | UL8750, CSA C22.2 No. 250.0-08, EN61347-1, EN61347-2-13 independent (except for HLG-320H C type), IP65 or IP67, J61347-1, J61347-2-13 approved |             |                |             |                |             |             |             |            |  |
|                         | WITHSTAND VOLTAGE  | I/P-O/P:3.75KVAC I/P-FG:2KVAC O/P-FG:0.5KVAC   |             |                |             |                |             |             |             |            |  |
|                         | ISOLATION RESISTANCE   | I/P-O/P, I/P-FG, O/P-FG:100M Ohms / 500VDC / 25°C / 70% RH   |             |                |             |                |             |             |             |            |  |
|                         | EMC EMISSION   | Compliance to EN55015, EN55022 (CISPR22) Class B, EN61000-3-2 Class C (≥50% load) ; EN61000-3-3  |             |                |             |                |             |             |             |            |  |
|                         | EMC IMMUNITY   | Compliance to EN61000-4-2,3,4,5,6,8,11, EN61547, EN55024, light industry level (surge 4KV), criteria B   |             |                |             |                |             |             |             |            |  |
| OTHERS                  | MTBF   | 157.1K hrs min. MIL-HDBK-217F (25°C)   |             |                |             |                |             |             |             |            |  |
|                         | DIMENSION  | 252*90*43.8mm (L*W*H)  |             |                |             |                |             |             |             |            |  |
|                         | PACKING  | 1.88Kg; 8pcs/16Kg/0.92CUFT   |             |                |             |                |             |             |             |            |  |
| NOTE                    | <ol style="list-style-type: none"> <li>All parameters NOT specially mentioned are measured at 230VAC input, rated load and 25°C of ambient temperature.</li> <li>Ripple &amp; noise are measured at 20MHz of bandwidth by using a 12" twisted pair-wire terminated with a 0.1uf &amp; 47uf parallel capacitor.</li> <li>Tolerance : includes set up tolerance, line regulation and load regulation.</li> <li>Constant current operation region is within 50%~100% rated output voltage. This is the suitable operation region for LED related applications, but please reconfirm special electrical requirements for some specific system design.</li> <li>Derating may be needed under low input voltages. Please check the static characteristics for more details.</li> <li>A type and C type only.</li> <li>Safety and EMC design refer to EN60598-1, subject CNS15233, GB7000.1, FCC part18.</li> <li>Length of set up time is measured at cold first start. Turning ON/OFF the power supply may lead to increase of the set up time.</li> <li>The power supply is considered as a component that will be operated in combination with final equipment. Since EMC performance will be affected by the complete installation, the final equipment manufacturers must re-qualify EMC Directive on the complete installation again.</li> <li>Refer to warranty statement.</li> </ol> |  |             |                |             |                |             |             |             |            |  |

**Mechanical Specification**

Case No.202A Unit:mm

Blank:(HLG-320H)

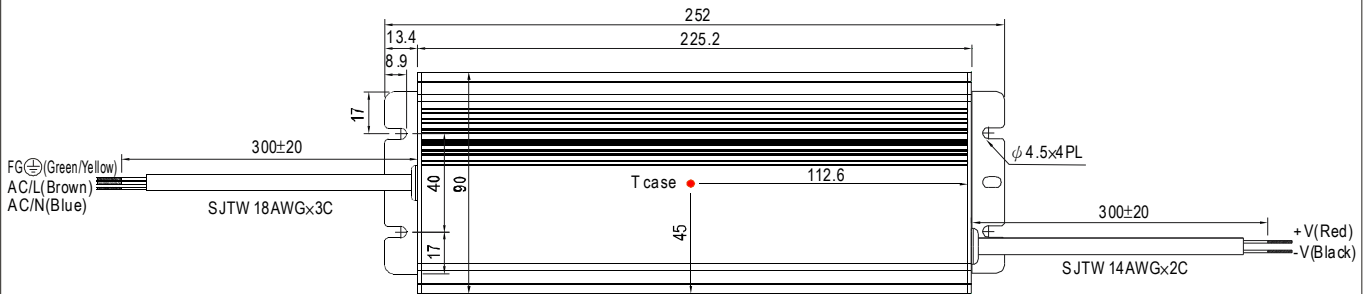

※ T case: Max. Case Temperature.

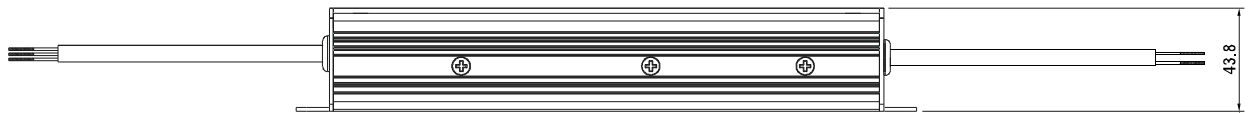

※IP67 rated. Cable for I/O connection.

A Type:(HLG-320H-A)

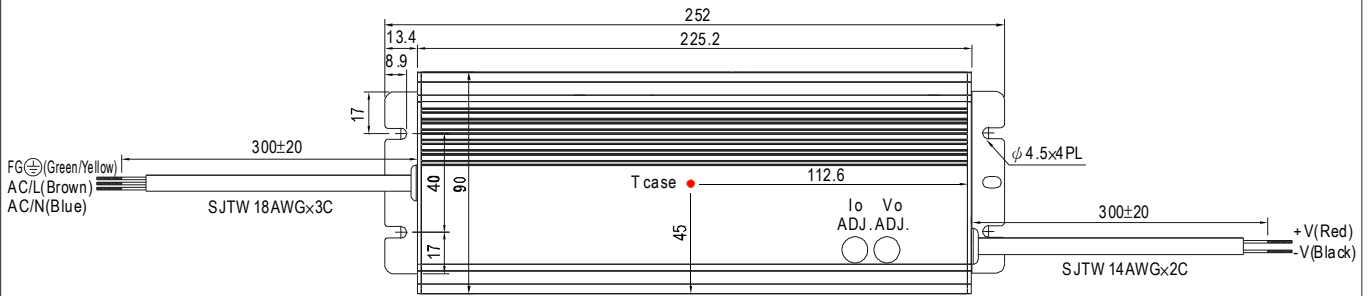

※ T case: Max. Case Temperature.

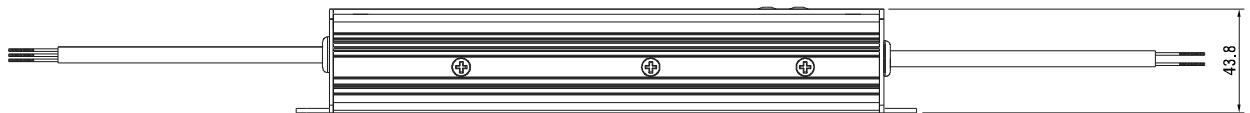

※IP65 rated. Output voltage and constant current level can be adjusted through internal potentiometer.  
(Can access by removing the rubber stopper on the case.)

**B Type:(HLG-320H- B)**

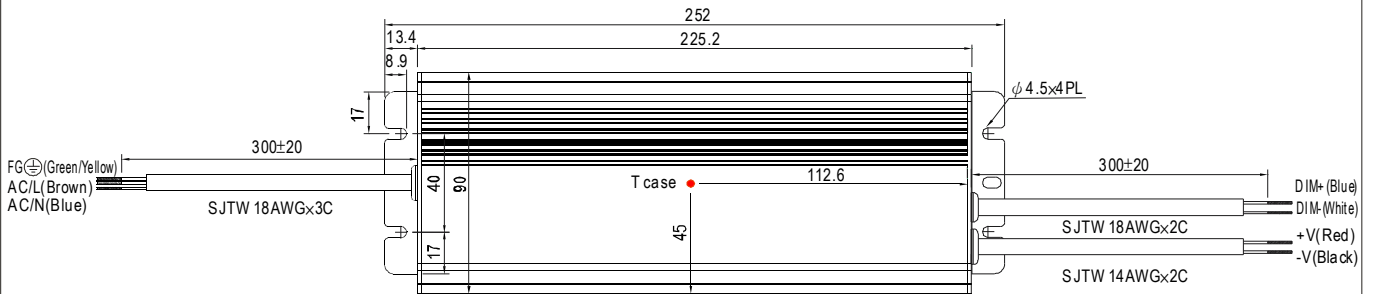

※ T case: Max. Case Temperature.

**C Type:(HLG-320H- C)**

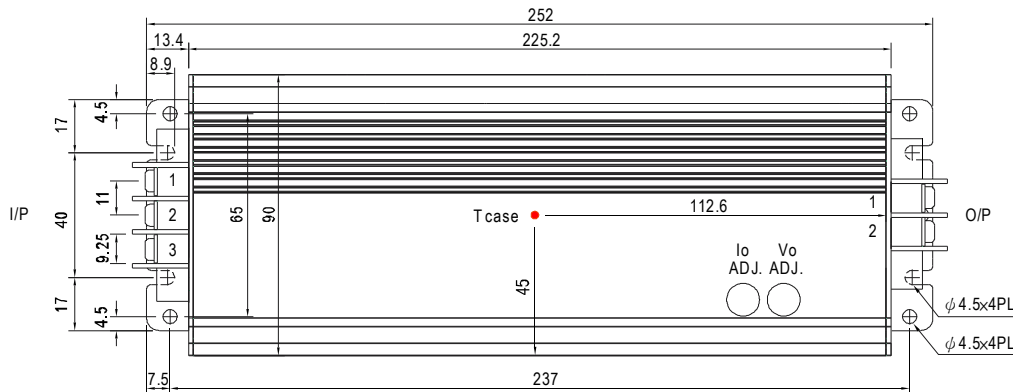

※ T case: Max. Case Temperature.

※ Output voltage and constant current level can be adjusted through internal potentiometer.  
(Can access by removing the rubber stopper on the case.)

AC Input Terminal Pin No. Assignment

| Pin No. | Assignment |
|---------|------------|
| 1       | FG $\perp$ |
| 2       | AC/L       |
| 3       | AC/N       |

DC Output Terminal Pin No. Assignment

| Pin No. | Assignment |
|---------|------------|
| 1       | +V         |
| 2       | -V         |

**D Type(option):(HLG-320H\_D)**

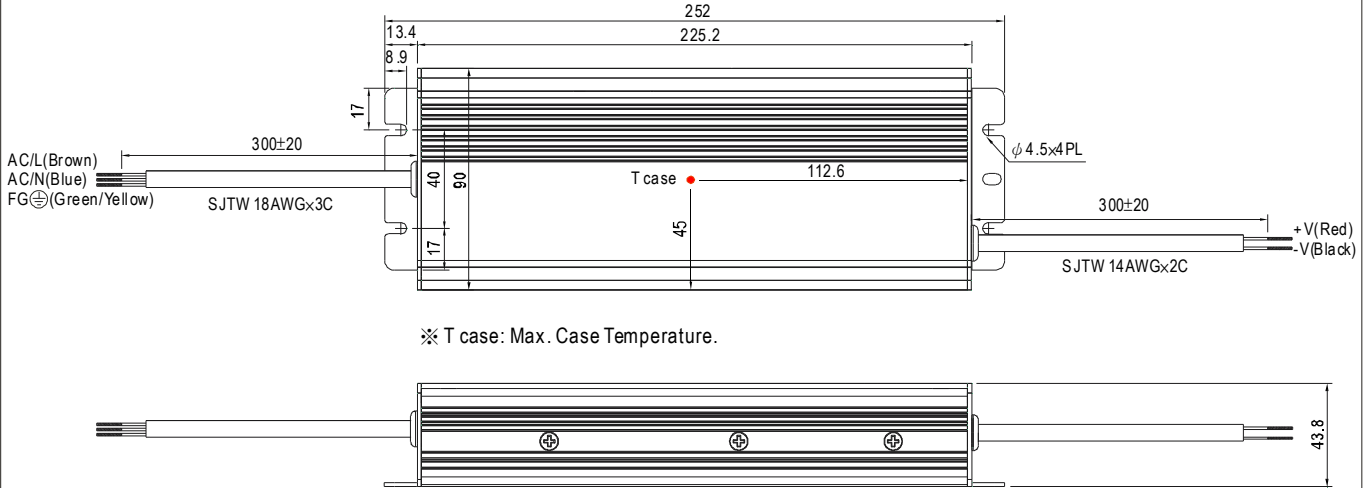

※ IP67 rated. Timer dimming function, contact MEAN WELL for details.

**Block Diagram**

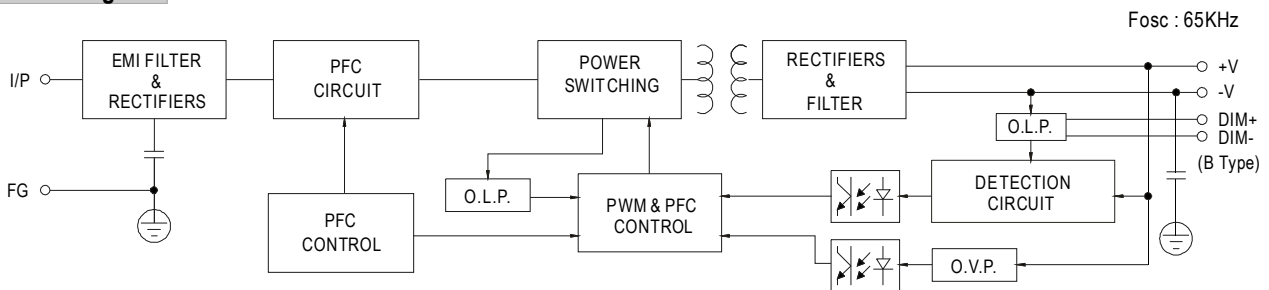

**Derating Curve**

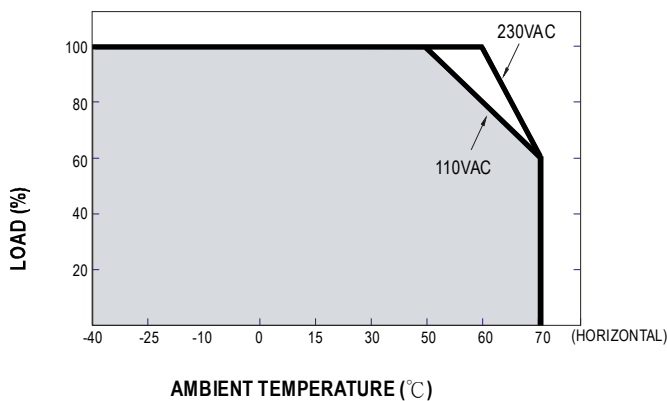

**Static Characteristics**

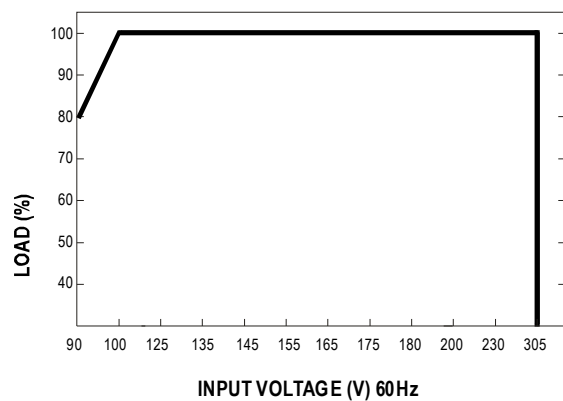

**Power Factor Characteristic**

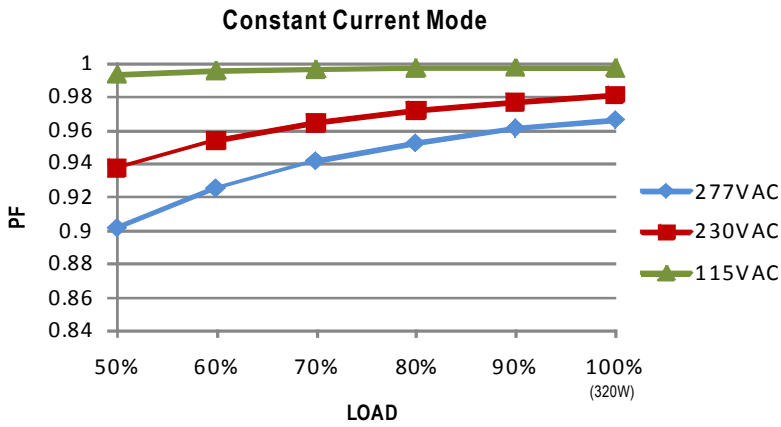

**EFFICIENCY vs LOAD (48V Model)**

HLG-320H series possess superior working efficiency that up to 95% can be reached in field applications.

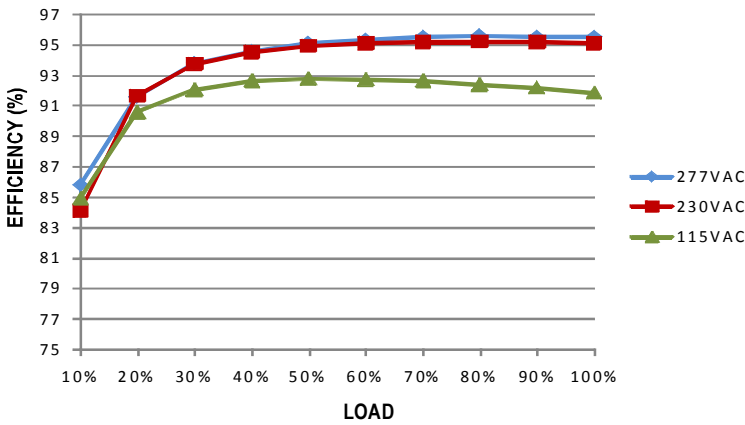

**DRIVING METHODS OF LED MODULE**

There are two major kinds of LED drive method "direct drive" and "with LED driver".

A typical LED power supply may either work in "constant voltage mode (CV) or constant current mode (CC)" to drive the LEDs.

Mean Well's LED power supply with CV+ CC characteristic can be operated at both CV mode (with LED driver, at area (A) and CC mode (direct drive, at area (B)).

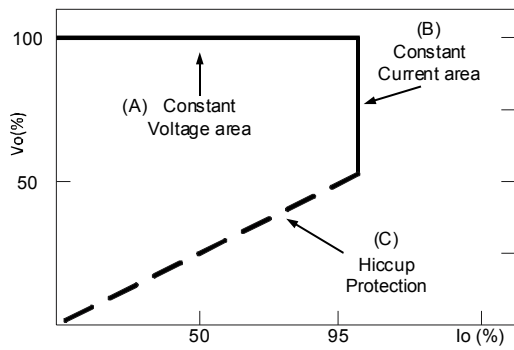

Typical LED power supply I-V curve

**■ DIMMING OPERATION (for B-type only)**

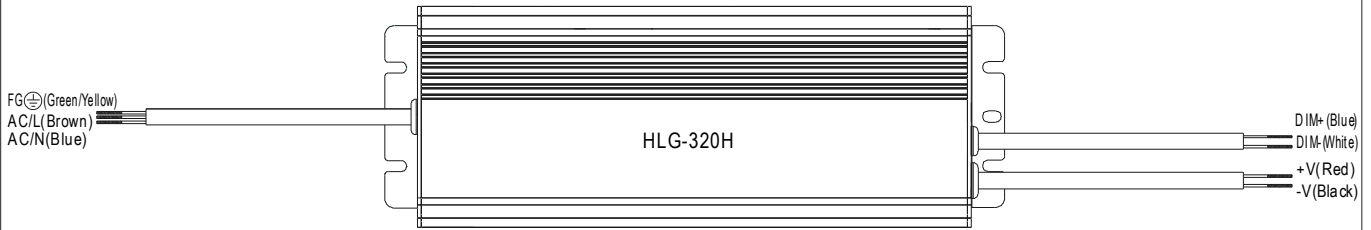

※ Built-in 3 in 1 dimming function, IP67 rated. Output constant current level can be adjusted through output cable by connecting a resistance or 1 ~ 10Vdc or 10V PWM signal between DIM+ and DIM-.

※ Please DO NOT connect "DIM-" to "-V".

※ Reference resistance value for output current adjustment (Typical)

| Resistance value            | Single driver | 10KΩ   | 20KΩ   | 30KΩ   | 40KΩ   | 50KΩ   | 60KΩ   | 70KΩ   | 80KΩ   | 90KΩ   | 100KΩ  | OPEN     |
|-----------------------------|---------------|--|--------|--------|--------|--------|--------|--------|--------|--------|--------|----------|
|                             |               | Multiple drivers<br>(N=driver quantity for synchronized dimming operation) | 10KΩ/N | 20KΩ/N | 30KΩ/N | 40KΩ/N | 50KΩ/N | 60KΩ/N | 70KΩ/N | 80KΩ/N | 90KΩ/N | 100KΩ/N  |
| Percentage of rated current |               | 10%  | 20%    | 30%    | 40%    | 50%    | 60%    | 70%    | 80%    | 90%    | 100%   | 95%~108% |

※ 1 ~ 10V dimming function for output current adjustment (Typical)

| Dimming value               | 1V  | 2V  | 3V  | 4V  | 5V  | 6V  | 7V  | 8V  | 9V  | 10V  | OPEN     |
|-----------------------------|-----|-----|-----|-----|-----|-----|-----|-----|-----|------|----------|
| Percentage of rated current | 10% | 20% | 30% | 40% | 50% | 60% | 70% | 80% | 90% | 100% | 95%~108% |

※ 10V PWM signal for output current adjustment (Typical): Frequency range :100HZ ~ 3KHz

| Duty value                  | 10% | 20% | 30% | 40% | 50% | 60% | 70% | 80% | 90% | 100% | OPEN     |
|-----------------------------|-----|-----|-----|-----|-----|-----|-----|-----|-----|------|----------|
| Percentage of rated current | 10% | 20% | 30% | 40% | 50% | 60% | 70% | 80% | 90% | 100% | 95%~108% |

※ Using the built-in dimming function on B-type model can't turn the lighting fixture totally dark. Please refer to the connection method below to achieve 0% brightness of the lighting fixture connecting to the LED power supply unit.

※ Direct connecting to LEDs is suggested, but is not suitable for using additional drivers.

Dimming connection diagram for turning the lighting fixture ON/OFF :

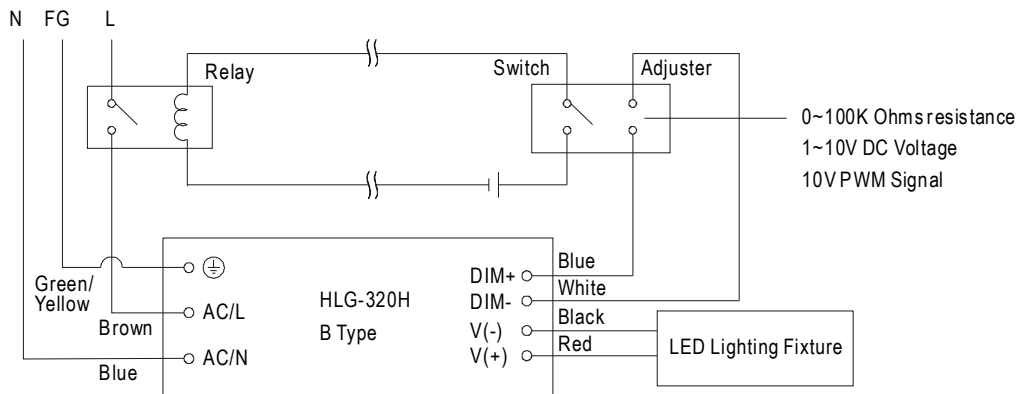

Using a switch and relay can turn ON/OFF the lighting fixture.

1. Output constant current level can be adjusted through output cable by connecting a resistance or 1~10Vdc or 10V PWM signal between DIM+ and DIM-.
2. The LED lighting fixture can be turned ON/OFF by the switch.

## WATERPROOF CONNECTION

### Waterproof connector

Waterproof connector can be assembled on the output cable of HLG-320H to operate in dry/wet/damp or outdoor environment.

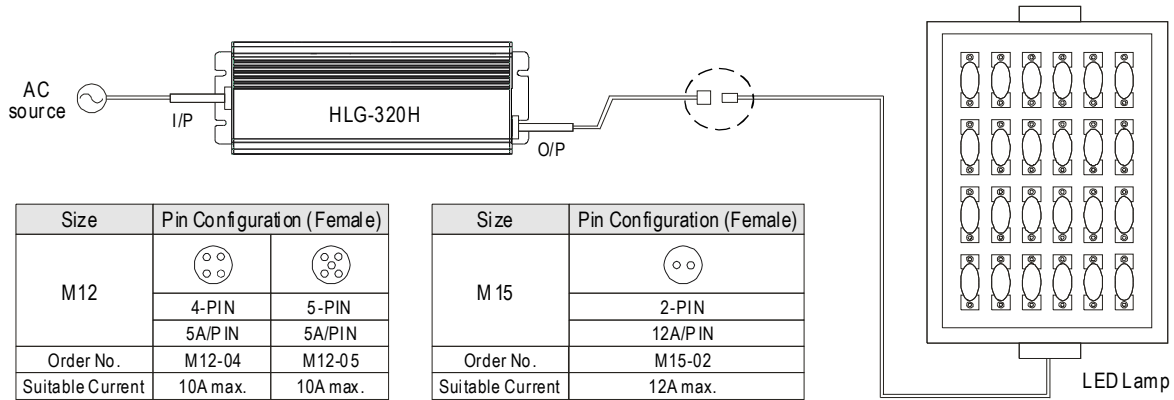

### Cable Joiner

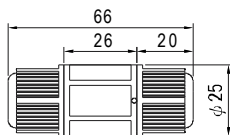

CJ04-1 suitable for 14AWG~16AWG  
CJ04-2 suitable for 18AWG~22AWG



Up to four wires can be connected through this cable joiner by soldering or clamping by tools.

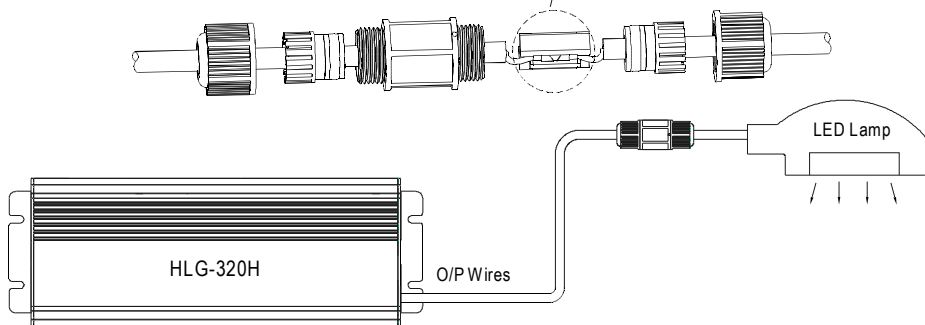

※CJ04 cable joiner can be purchased independently for user's own assembly.  
MEAN WELL or der No. : CJ04-1, CJ04-2.

### Junction Box (Option)

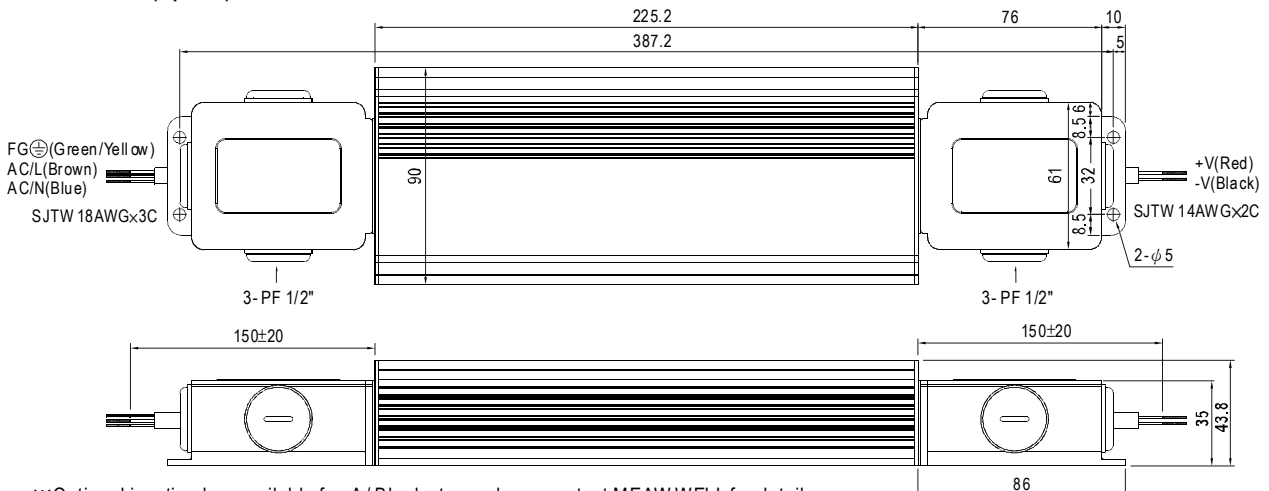

※Optional junction box available for A/ Blank - type, please contact MEAN WELL for details.