

PowerRail 310

Operating Manual

February 2010



1 Safety

This instruction sheet gives details of safe installation and operation of the **Rail310** electricity meter. Safety may be impaired if the instructions are not followed. Labels on each meter give details of equipment ratings for safe operation. Take time to examine all labels before commencing installation. Safety symbols on the meter have specific meanings.



Refer To User Manual

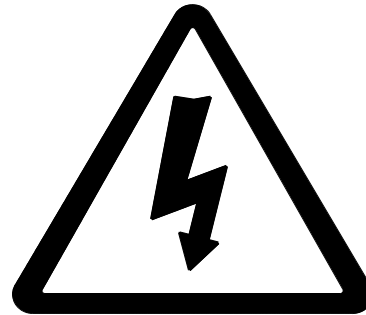

Risk of Electric Shock

WARNING

The meter contains no user serviceable parts. Installation and commissioning should only be carried out by qualified personnel

Further information is available at <http://www.ndmeter.co.uk>.

2 Operation

2.1 Three Meters in One Box

The **Rail310** consists of three multi-function electricity meters in a single enclosure. The unit independently monitors up to three single-phase loads providing a clear digital displays of kW, kWh, volts and amps.

Three pulse outputs are also available allowing each kWh register to be remotely monitored/logged. An RS485 Modbus RTU serial communications link may be optionally fitted providing multi-function meter readings to remote SCADA systems.

2.2 Energy Displays

Press  to select the kWh register for each meter.

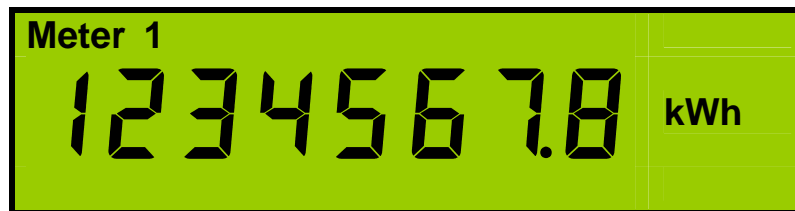

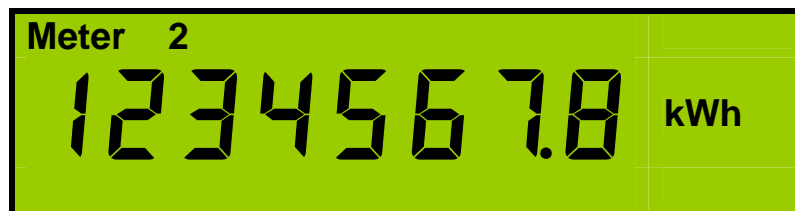

Active Energy Register - Meter 1

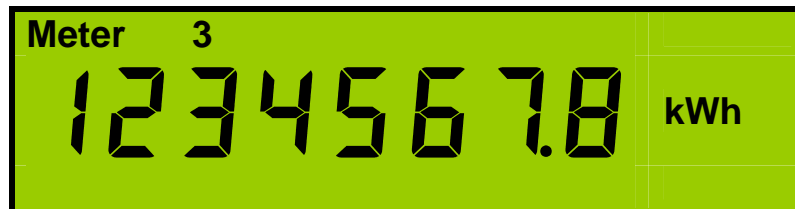

Active Energy Register - Meter 2



Active Energy Register - Meter 3

Press  and  together and hold for 2 seconds to simultaneously reset the three kWh registers, if this feature is enabled.

Scaling of the energy registers is set by the nominal input currents and voltages and remains constant during operation of the meter.

Energy registers will each accumulate from zero to 99,999,999 then restart from zero.

2.3 Current and Voltage Displays

Press  to select from the following displays;



True RMS Amps - Meter 1



True RMS Amps - Meter 2



True RMS Amps - Meter 3



True RMS Volts - Meter 1



True RMS Volts - Meter 2



True RMS Volts - Meter 3

Operation

2.4 kW Displays

Press  to select the instantaneous kW displays for each meter.



Active Power - Meter 1



Active Power - Meter 2

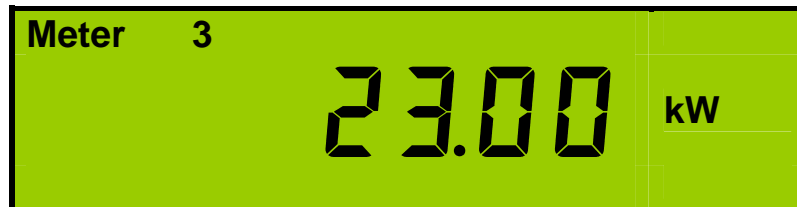

Active Power - Meter 3

2.5 Pulse Outputs

Three isolated pulse outputs are provided for connection to external systems such as Building Energy Management Systems (BEMS), data loggers, remote counters etc.

Pulse 1 is associated with the active energy (kWh) register of Meter 1, Pulse 2 with Meter 2 and Pulse 3 with Meter 3.

A single pulse occurs for each unit of energy on the display (eg 1 pulse per 0.1kWh). The pulse rate (amount of energy associated with each pulse) and pulse length is programmable and may be set to suit the external system.

Pulse outputs take the form of a volt free contact closure.

- Pulse 1 provides a momentary short circuit between contacts C and P1 each time Meter 1 kWh register increments a set number of times.
- Pulse 2 provides a momentary short circuit between contacts C and P2 each time Meter 2 kWh register increments a set number of times.
- Pulse 3 provides a momentary short circuit between contacts C and P3 each time Meter 3 kWh register increments a set number of times.

2.5.1 Pulse LED

A Light emitting diode (LED) on the front panel of the instrument remains ON during each output pulse of the meter, which is currently shown on the LCD.



Pulse Output Indicator

3 Programming

3.1 Programming Menu

To enter programming mode:



Hold  and  together for 5 Seconds.

A **Security Code** may be required before changes to programmed parameters are allowed. This is only required if a **Security Code** greater than zero is set via serial communications. This is then stored in non-volatile memory during power interruptions.



4-Digit Security Code

To Enter the Security Code:

Press  or  to change each digit. (Lowest significant digit first).

Press  to select next most significant digit.

When a valid code is entered, the first page of the programming menu is displayed.





Programming Menu First Page

3.2 Setting The CT Primary Current

External current transformers (CTs) are required to reduce large currents to a level accepted as inputs to the meter. The Rail310 meter displays require scaling to match the primary current rating of the external Current Transformers used.

Each meter in the unit uses the same CT primary current rating.



Press  or  to select the Next/Previous CT Primary current from the preferred list.





Setting The CT Primary Current

3.2.1 Fine Adjust CT Primary

If values other than those found in the preferred list are required use **Fine Adjust Mode**:

Hold  and  together for 2 Seconds to select/deselect **Fine Adjust Mode** "CTF".

Press  or  to increment the CT Primary current in steps of 5A.

When the desired CT primary current has been set press  to move to the next parameter.

3.3 Setting The Pulse Output Rate

The amount of energy associated with each momentary pulse output may be programmed. A single setting is required to scale all three Meter pulse outputs.



Setting The Pulse Output Rate

Press  or  to select the Next/Previous **Pulse Rate** from the preferred list.

When the desired Pulse Rate has been set press  to move to the next parameter.

3.4 Setting The Pulse On Time

The length of time (in seconds) each momentary pulse output remains “ON” (short circuit) may be programmed. A single setting is required to scale all three Meter pulse outputs.



Setting The Pulse Output Rate

Press  or  to select the Next/Previous **Pulse On Time** from the preferred list.

When the desired Pulse Rate has been set press  to move to the next parameter.

Note: When selecting a long **Pulse On Time** it may be necessary to reduce the **Pulse Rate** to prevent pulses appearing permanently “ON”.

3.5 Pulse Output Test Mode

This feature allows the pulse output hardware and external system connections to be commissioned without a measured load.

The test pulse rate is set automatically dependant on the programmed pulse length (maximum 0.5Hz).

Press  to start/stop the test pulses on all outputs.

Pulse Output Test OFF Mode

In this mode no pulses occur on P1-P3 and the display shows the total number of pulses accumulated during testing:





Pulse Output Test RUN Mode

In this mode pulses occur simultaneously on all three outputs with an **Pulse On Time** set in programming mode above. The **Pulse Rate** is set automatically to be greater than twice the **Pulse On Time**.

The display shows the total number of pulses accumulated during testing



Press  and  together to stop the test pulses and simultaneously reset the test counter.

When the test is complete press  to move to the next parameter.

Note: When selecting a long **Pulse On Time** it may be necessary to reduce the **Pulse Rate** to prevent pulses appearing permanently "ON".

4 Display Scaling

The units, kWh or MWh and the position of the decimal point for the energy/power displays are automatically set dependant on the **CT Primary** setting for the meter.

The display pages are scaled as follows:

CT Primary	Display Resolution			
	Amps	Volts	Power	Energy
<10 A	0.001A	0.1V	0.001kW	0.001kWh
=10 A	0.01A	0.1V	0.001kW	0.001kWh
<=80 A	0.01A	0.1V	0.01kW	0.01kWh
<=100 A	0.1A	0.1V	0.01kW	0.01kWh
<=800 A	0.1A	0.1V	0.1kW	0.1kWh
<=1,000 A	1A	0.1V	0.1kW	0.1kWh
<=8,000 A	1A	0.1V	1kW	1kWh
<=10,000 A	0.01kA	0.1V	1kW	1kWh
<=25,000 A	0.01kA	0.1V	0.01MW	0.01MWh

5 Installation

5.1 Mounting On A Rail

The **Rail310** conforms to DIN 43880, 6-Module Wide. The unit is therefore compatible with a number of standard distribution systems with 45mm cut-outs. The meter should be mounted on a 35mm symmetrical ("Top-Hat") DIN rail of minimum length 106mm.

5.2 Pulse Output Connection

The pulse outputs take the form of isolated volt free normally open contacts.

The pulse output circuit is isolated from all other circuits at 2.5kV / 1 minute.

The pulses can be used as an input to a remote counter, pulse logger, building energy management system etc.

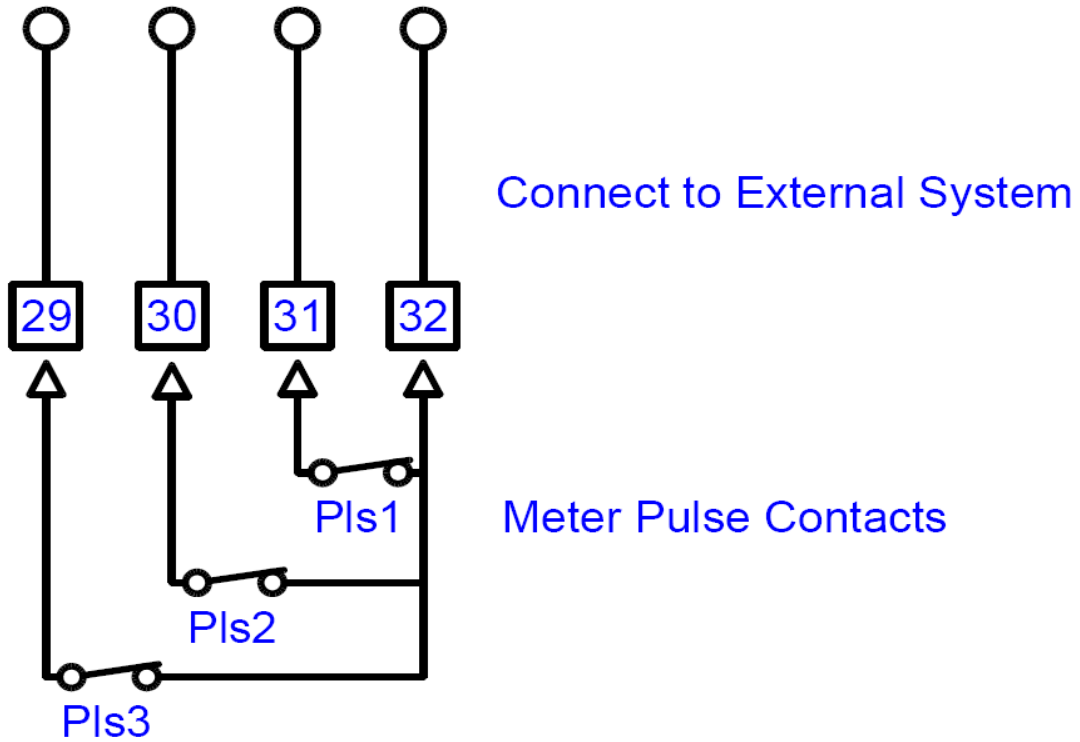

Pulse Output Connections

6 Standard Connections

6.1 Measurement Input Connections

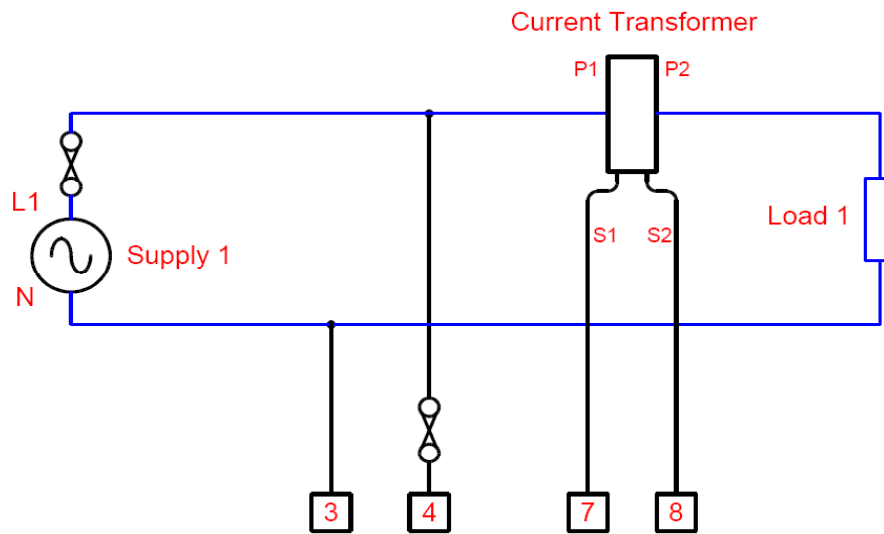

Meter 1 Measurement Input Connections

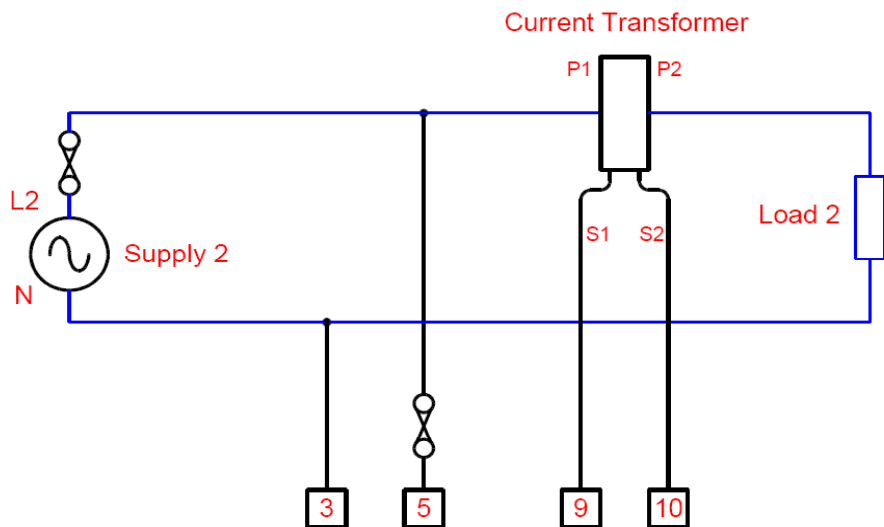

Meter 2 Measurement Input Connections

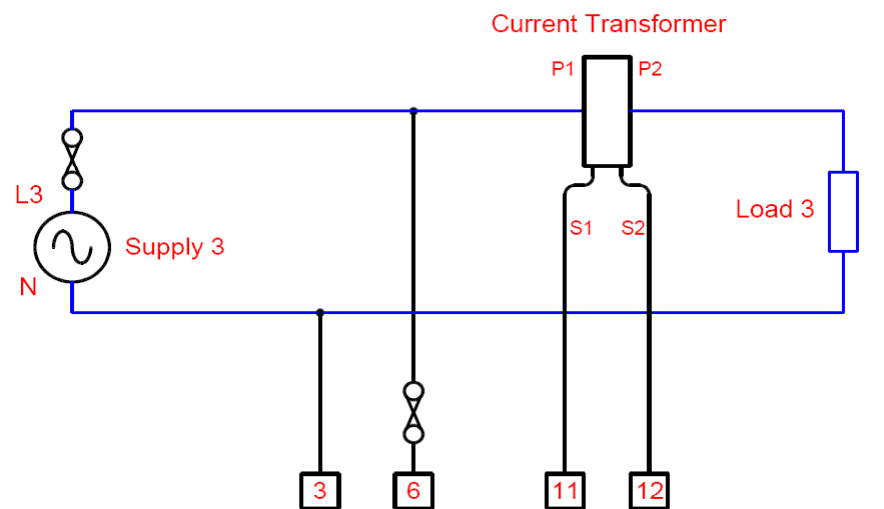

Meter 3 Measurement Input Connections

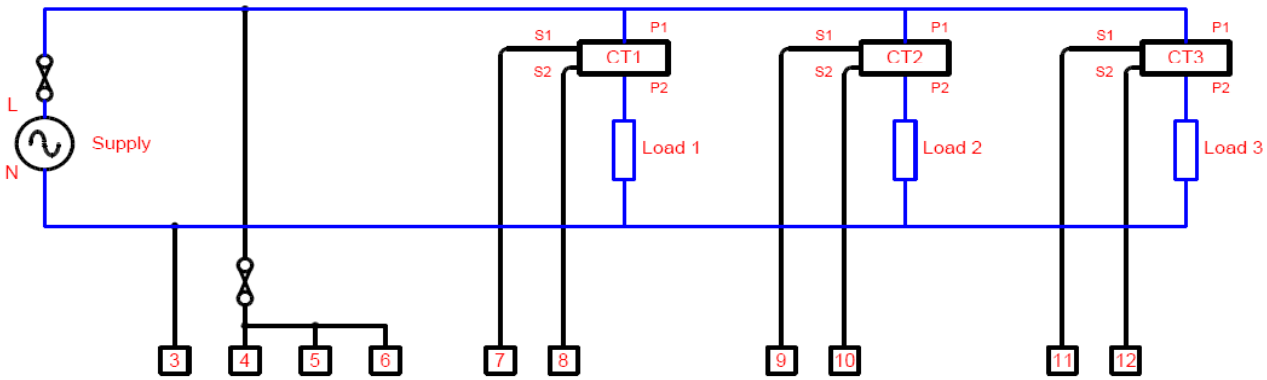

Meters 1-3 With Common Voltage Input

6.1.1 Voltage Measurement Input Fuses

It is recommended to fit a fuse/circuit-breaker to each voltage measurement input. This allows the **Rail310** to be isolated should maintenance be required.

Each meter voltage measurement input takes less than 1mA at nominal 230V.

Recommended fuses should be rated at 250V / 100mA (Type T).

6.1.2 Common Neutral

The voltage measurement inputs must be sourced from a supply with a common neutral point. Suitable circuits include; several feeders off a single-phase circuit or individual phases of a 3-phase 4 wire supply.

6.2 Auxiliary Meter Supply

The **Rail310** requires an ac supply to power the measurement circuit and display. This can be any ac supply meeting the specification stated on the units rating label.

It is acceptable to cross connect the meter supply with one of the voltage measurement inputs providing the specified ratings are not exceeded.

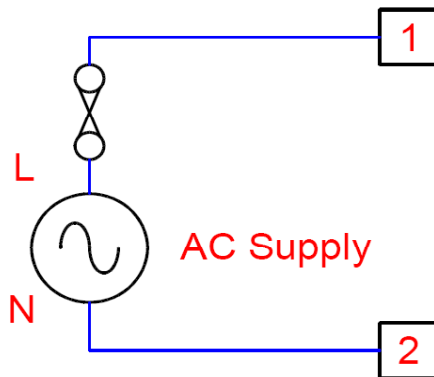

Rail310 Unit Auxiliary Supply

6.2.1 Auxiliary Supply Fuse

The auxiliary supply is not fused internally in the **Rail310**. An external fuse must be fitted.

External Auxiliary Supply fuses should be rated:

No of Rail310 Units	Fuse Rating
1-10	250V / 500mA Anti-Surge
11-20	250V / 1A Anti-Surge
20-50	250V / 2.5A Anti-Surge
>50	Use multiple fuses as above

7 Specification

INPUTS	
System	3 Loads with a common neutral
Voltage Un	Standard: 3 x 230Vac Optional: 3 x 120Vac
Current In	Standard: 5A from external CTs. Optional: 1A from external CTs. Optional: 0.333V from external current sensors
Measurement Range	Voltage 50% to 120% Current 0.2% to 120%
Frequency Range	Fundamental 45 to 65Hz Harmonics Up to 30th harmonic at 50Hz
Burden	Voltage <0.1VA per meter Current <0.1VA per meter
Overload	Voltage x2 for 1 hour Current x20 for 0.5 second max
DISPLAY	
Type	Custom, Supertwist, LCD
Data Retention	10 years min. Stores kWh & Meter set-up
Format	8 x 9mm high digits with DPs & 2.8mm legends
Scaling	Direct reading. User programmable CT CT Primary programmable from 5A to 25,000A
Legends	kWh, MWh etc. depending on user settings
AUXILIARY SUPPLY	
Standard	230V 50/60 Hz ±15%
Options	115V 50/60 Hz ±15%
Load	2VA max.
Overload	x1.2 continuous
ACCURACY All errors ± 1 digit	
kWh	Better than Class 1 per EN 62053-21 & BS 8431
kW	Better than Class 0.25 IEC 60688
Amps & Volts	Class 0.1 IEC 60688 (0.01In – 1.2In or 0.1Un – 1.2Un)
PF (Modbus Only)	±0.2° (0.05In – 1.2In and 0.2Un – 1.2Un)
PULSE OUTPUTS	
Function	1 Pulse per unit of energy
Pulse Rate	Settable between 1 & 1000 counts of kWh register
Pulse On Time	0.1 sec. default; Settable between 0.1 and 20 sec
Rise & Fall Time	< 2.0ms
Type	N/O Volt free contact. Optically isolated BiFET
Contacts	100mA ac/dc max., 100V ac/dc max: 0.5W Max Load
Isolation	2.5kV 50Hz 1 minute
MODBUS® Serial Communications (Optional)	
Bus Type	RS485 2 wire + 0v. ½ Duplex, ¼ unit load
Protocol	MODBUS® RTU with 16 bit CRC
Baud Rate	4800, 9600 or 19,200 User settable
Address	1 – 247 User settable
Latency	Reply within 250ms max.
Command Rate	New command within 5ms of previous one
GENERAL	
Temperature	Operating -10°C to +55°C Storage -25°C to +70°C
Humidity	< 75% non-condensing
Environment	IP20
MECHANICAL	
Terminals	Rising Cage. 4mm ² (12 AWG) cable max.
Enclosure	DIN 43880, 6-Modules Wide
Material	Noryl® with fire protection to UL94-V-O. Self extinguishing
Dimensions	106 x 90 x 58mm (Cut out 106 x 45mm)
Weight	~ 250 gms
SAFETY	
Conforms to	EN 61010-1 Installation Category III