

Features

- Single and 3 phase options
- Adjustable setpoint
- Adjustable time delay
- Internal differential
- LED trip indication
- Double pole relay contacts
- Automatic reset

Benefits

- Ideal for any electrical load detection
- Over and under current monitoring
- Suitable for electric heating systems
- Ensures load current is within generator capacity
- Detects broken drive belts on machinery
- Nuisance tripping avoidance
- Customized options

Applications

- Marine panels
- Switchgear
- Distribution systems
- Generator sets
- Control panels
- Process control
- Motor protection
- Transformers
- Overload protection

Approvals

UL, CSA, BV and ABS

A.C. Current with Adjustable Time Delay

250 series A.C. current protectors provide continuous surveillance of the monitored circuit. When the current moves outside the setpoint limit, the relay operates. The protector can be used to monitor over and under current conditions, load detection, and for monitoring electric heating systems. An illuminated LED indicates when the relay is energized. For 3 phase systems, the sequence of connection is not important.

Operation

A.C. current protectors provide continuous surveillance of the monitored circuit. These products offer user adjustable trip point (setpoint) and time delay settings. The setpoint adjustment range is between 40% and 120% of the nominal current. Input currents can be via current transformers or direct up to 10A. An internal differential setting of 1% reduces nuisance tripping if the measured signal is noisy or unstable. When the measured current moves outside the setpoint limit, the relay will operate, giving an alarm or initiation signal. An adjustable time delay is provided to prevent the relay from tripping for a predetermined period to prevent nuisance tripping. The units draw their operating power from a separate auxiliary supply input. Single phase and three phase products are available. Three phase products monitor the current level for each phase, and are not phase sequence sensitive. Combined units offer under and over current trips in one compact unit. Single function units are also available.

Over Current Models

When the monitored current exceeds the setpoint, the relay will energize and the red LED will illuminate to indicate the trip condition. The relay will automatically reset once the monitored current falls below the setpoint minus the differential. When reset, the LED will extinguish and the relay de-energizes.

Under Current Models

When the monitored current falls below the setpoint, the relay will de-energize and the red LED will extinguish to indicate the trip condition. The relay will automatically reset once the monitored current rises above the setpoint plus the differential. When reset, the LED will illuminate and the relay energizes.

Options

250 series protector relays offer various customized options to suit individual requirements. Please consult factory.

- Adjustment ranges - different adjustment ranges are possible for the setpoint and differential controls.
- Relay operation - standard models are fail safe, but the relays can be customized to energize or de-energize on trip.

Product Codes

Relay	Protection	ANSI No.	Catalog No.
Single phase	Under current 40-120%	37	252-PAU
Single phase	Over current 40-120%	51	252-PAO
Single phase	Under and over current	37/51	253-PAD
3 phase 3 or 4 wire	Under current 40-120%	37	253-PAV
3 phase 3 or 4 wire	Over current 40-120%	51	253-PAP

Specify system voltage, system current, frequency and required options at time of ordering.

Provided by: K-Tech Inc. Ph:1 847 375 9524, Fx:1 847 375 9523
www.K-Tech.com info@k-tech.com

250 Series DIN Rail and Wall Mounted Relays

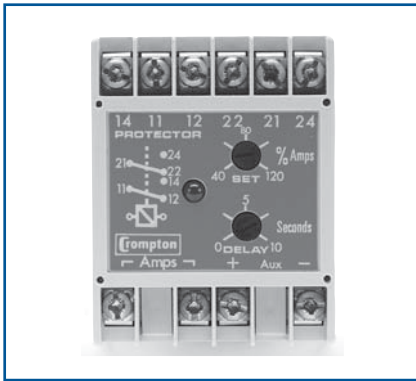

Specification – AC Current with Adjustable Time Delay

Nominal Input Current	1A or 5A from CT secondary. 0.2A to 10A available on request
Nominal Frequency	50, 60 or 400Hz
Input Current Burden	0.5VA per phase
Overload	2 x rating continuously, 10 x rating for 3 seconds
Set Point Repeatability	>0.5% of full span
Differential (Hysteresis)	Preset at 1%. Values 1% to 10% available on request
Trip Level Adjustment	40 to 120%. Customized adjustment available
Time Delay Adjustable	0 to 10 seconds
AC Auxiliary Supply Voltage	100V, 110V, 120V, 208V, 220V, 240V, 480V, ±20%
DC Auxiliary Supply Voltage	12V, 24V, 48V, 110V or 125V, ±15%. Max ripple 15%
Auxiliary Voltage Burden	4VA (max)
Output Relay	Double pole change over
Relay Contact Rating	AC: 240V 5A, non inductive DC: 24V, 5A resistive
Relay Mechanical Life	0.2 million operations at rated loads
Relay Reset	Automatic
Operating Temperature	0°C to +60°C (0°C to +40°C for UL models)
Storage Temperature	-20°C to + 70°C
Temperature Co-efficient	0.05% per °C
Interference Immunity	Electrical stress surge withstand and non-function to ANSI/IEEE C37 90a
Enclosure Style	DIN rail with wall mounting facility
Material	Flame retardant polycarbonate/ABS
Enclosure Integrity	IP50
Compliant With	EMC, LVD, Safety Standard IEC 414 UL File No: E113067 recognized up to 600V CSA File No: LR52592 up to 300V BV File No: 2650H-07427-AO-PRSO BV ABS File No: 93-LD 17806-X
Model 252 Dimensions	55mm (2.2") wide x 70mm (2.8") high x 112mm (4.4") deep
Model 253 Dimensions	75mm (2.9") wide x 70mm (2.8") high x 112mm (4.4") deep
Weight	Model 252: 0.4Kg approx. Model 253: 0.6Kg approx.

Connections

252-PAU
252-PAO

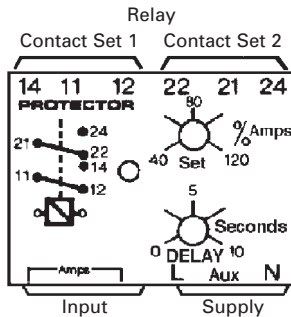

253-PAD

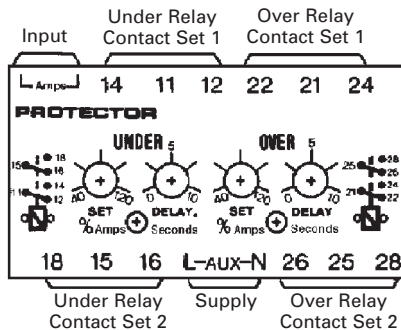

253-PAP
253-PAV

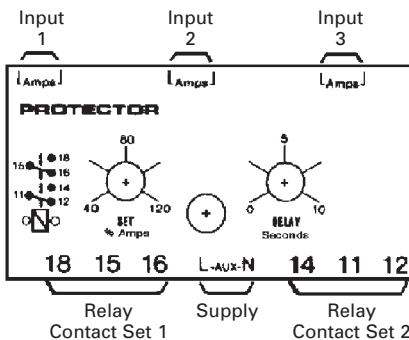

Dimensions

Model 252

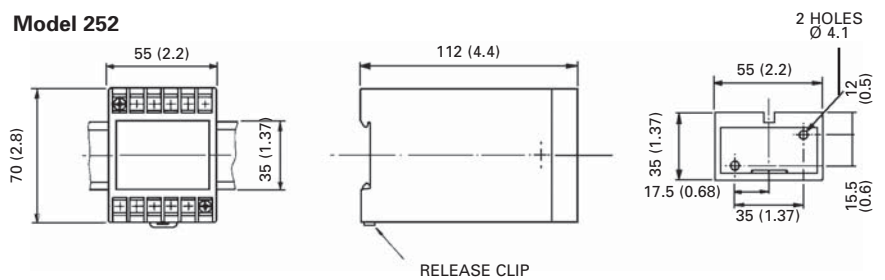

Model 253

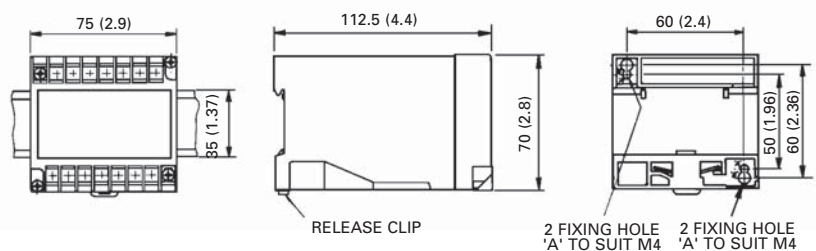

Provided by: K-Tech Inc. Ph:1 847 375 9524, Fx:1 847 375 9523
www.K-Tech.com info@k-tech.com

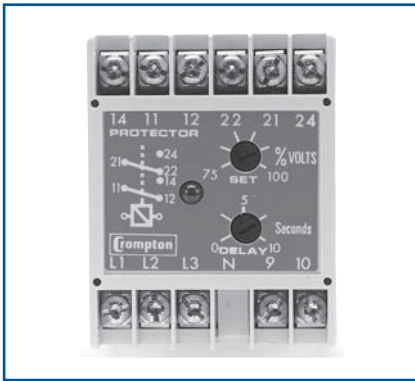

A.C. Voltage with Adjustable Time Delay

The A.C. voltage protectors provide continuous surveillance of the monitored circuit. When the measured voltage moves outside the setpoint limit, the relay will operate after the selected time delay, giving an alarm or initiation signal. Relays normally energize on overvolts and de-energize on undervolts. An illuminated LED indicates when the relay is energized.

Operation

A.C. voltage protectors offer user adjustable trip point (setpoint) and time delay settings. The setpoint adjustment range is 25%, operating between 75% and 100% of the nominal supply for under voltage units, and between 100% and 125% for the over voltage units. The time delay setting adjustment range is typically 0 to 10 seconds, although longer delays are available. As soon as the monitored signal moves outside of the setpoint limit, the time delay is activated, after which a trip will occur. The time delay prevents the relay from tripping for a predetermined period to prevent nuisance tripping.

The products also feature an internal differential (hysteresis) setting of 1% to reduce nuisance tripping if the measured signal is noisy or unstable. The units draw their operating power from the measuring inputs, although a separate auxiliary supply input option is available on some models. Single phase and three phase products are available, three phase products monitor the voltage level for each phase, and are not phase sequence sensitive.

Over Voltage Models

When the monitored voltage exceeds the setpoint, the time delay is started. When the time has elapsed, the relay will energize and the red LED will illuminate to indicate the trip condition. The relay will automatically reset once the monitored voltage falls below the setpoint minus the differential. When reset, the LED will extinguish and the relay de-energizes. The time delay is not active when resetting.

Under Voltage Models

When the monitored voltage falls below the setpoint, the time delay is started. When the time has elapsed, the relay will de-energize and the red LED will extinguish to indicate the trip condition. The relay will automatically reset once the monitored voltage rises above the setpoint plus the differential. When reset, the LED will illuminate and the relay energizes. The time delay is not active when resetting.

Options

250 series protector relays offer various customized options to suit individual requirements.

Please consult factory.

- Adjustment ranges - different adjustment ranges are possible for the setpoint and differential controls.
- Separate auxiliary supply - sometimes required to maintain a time delay or energized relay when the monitored signal fails.
- Differential - internally fixed value between 1% and 15%.
- Relay operation - standard models are fail safe, but the relays can be customized to energize or de-energize on trip.

Product Codes

Relay	Protection	ANSI No.	Catalog No.
Single phase	Under voltage 75-100%	27	252-PVZ
Single phase	Over voltage 100-125%	59	252-PVH
3 phase 3 wire	Under voltage 75-100%	27	252-PVJ
3 phase 3 wire	Over voltage 100-125%	59	252-PVC
3 phase 4 wire	Under voltage 75-100%	27	252-PVX
3 phase 4 wire	Over voltage 100-125%	59	252-PVS

Specify system voltage, frequency and required options at time of ordering.

Features

- Adjustable setpoint
- Adjustable time delay
- Internal differential
- LED trip indication
- Double pole relay contacts
- Automatic reset

Benefits

- Over and under voltage monitoring
- Close voltage control
- Start standby generators
- Operation of mains failure units
- Switching standby supplies
- Protecting computer supplies
- Monitors genset AVR and excitation systems
- Nuisance tripping avoidance
- Customized options

Applications

- Switchgear
- Distribution systems
- Generator sets
- Control panels
- Process control
- Motor protection
- Transformers
- Overload protection

Approvals

- UL and CSA

Provided by: K-Tech Inc. Ph:1 847 375 9524, Fx:1 847 375 9523
www.K-Tech.com info@k-tech.com

250 Series DIN Rail and Wall Mounted Relays

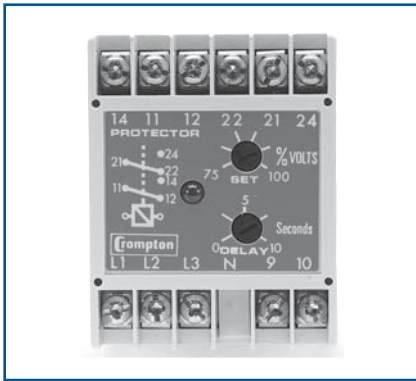

Specification – AC Voltage with Adjustable Time Delay

Nominal Voltage	100V, 110V, 208V, 240V, 277V, 400V, 415V, 440V or 480V
System Frequency	45/65Hz or 360/440Hz
Voltage Burden	0.3VA
Overload	1.2 x rating continuously, 1.5 x rating for 10 x seconds
Set Point Repeatability	> 0.5% of full span
Differential (Hysteresis)	Preset at 1%. Other values 1% to 10% to order
Trip Level Adjustment	Under Voltage: 75 to 100% Over Voltage: 100 to 125% of nominal input voltage
Time Delay	Adjustable up to 10 seconds
AC Auxiliary Supply Voltage	100V, 110V, 120V, 208V, 220V, 240V, 480V, ±20%
DC Auxiliary Supply Voltage	12V, 24V, 48V, 110V or 125V, ±15%. Max ripple 15%
Auxiliary Voltage Burden	4VA (max)
Output Relay	Double pole change over
Relay Contact Rating	AC: 240V 5A, non inductive DC: 24V, 5A resistive
Relay Mechanical Life	0.2 million operations at rated loads
Relay Reset	Automatic
Operating Temperature	0°C to +60°C (0°C to +40°C for UL models)
Storage Temperature	-20°C to +70°C
Temperature Co-efficient	0.05% per °C
Interference Immunity	Electrical stress surge withstand and non-function to ANSI/IEEE C37 90a
Enclosure Style	DIN rail with wall mounting facility
Material	Flame retardant polycarbonate/ABS
Enclosure Integrity	IP50
Compliant With	EMC, LVD, Safety Standard IEC 414 UL File No: E113067 recognized up to 600V CSA File No: LR52592 up to 300V
Dimensions	55mm (2.2") wide x 70mm (2.8") high x 112mm (4.4") deep
Weight	0.4Kg approx.

Connections

252-PVZ
252-PVH

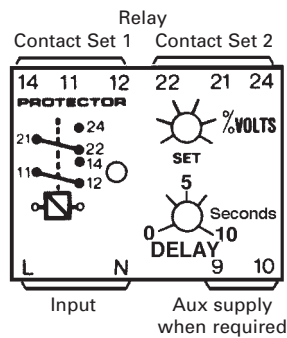

252-PVX
252-PVS
252-PVC
252-PVJ

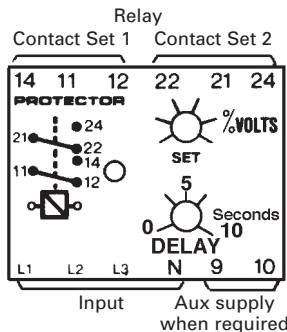

Note: The neutral connection is always used on 4 wire systems.

Dimensions

Model 252

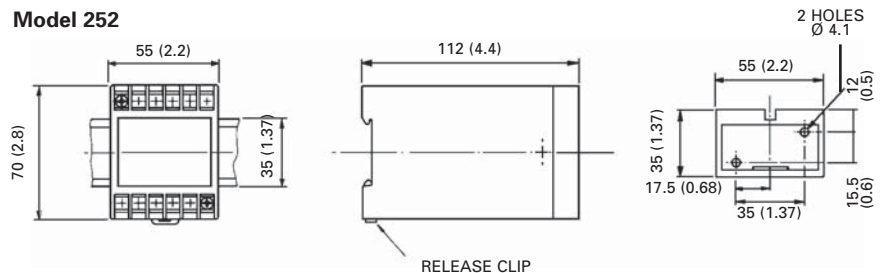

Provided by: K-Tech Inc. Ph:1 847 375 9524, Fx:1 847 375 9523
www.K-Tech.com info@k-tech.com

250 Series DIN Rail and Wall Mounted Relays

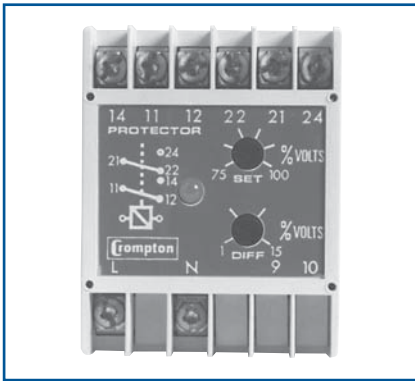

A.C. Voltage with Adjustable Differential

The A.C. voltage protectors provide continuous surveillance of the monitored circuit. When the measured voltage moves outside the setpoint limit, the relay will operate giving an alarm or initiation signal. The protector can be used for under and over voltage detection, start standby generators, operation of mains failure units, and switching standby supplies. An illuminated LED indicates when the relay is energized. The 3 phase, 3 or 4 wire models, protect each phase independently.

Operation

A.C. voltage protectors offer user adjustable trip point (setpoint) and differential (hysteresis) settings. The setpoint adjustment range is 25%, operating between 75% and 100% of the nominal supply for under voltage units, and between 100% and 125% for the over voltage units. The differential setting adjustment range is 1% to 15%, and it can be used to reduce nuisance tripping if the measured signal is noisy or unstable. When the measured voltage moves outside the setpoint limit, the relay will operate, giving an alarm or initiation signal.

As soon as the monitored signal moves outside of the setpoint limit, a trip will occur. A fixed time delay is available as a factory option, preventing the relay from tripping for a predetermined period to prevent nuisance tripping. The units draw their operating power from the measuring inputs, although a separate auxiliary supply input option is available on some models. Three phase products monitor the voltage level for each phase, and are not phase sequence sensitive. Combined units offer under and over voltage trips in one compact unit. Single function units are also available.

Over Voltage Models

When the monitored voltage exceeds the setpoint, the relay will energize and the red LED will illuminate to indicate the trip condition. The relay will automatically reset once the monitored voltage falls below the setpoint minus the differential. When reset, the LED will extinguish and the relay de-energizes.

Under Voltage Models

When the monitored voltage falls below the setpoint, the relay will de-energize and the red LED will extinguish to indicate the trip condition. The relay will automatically reset once the monitored voltage rises above the setpoint plus the differential. When reset, the LED will illuminate and the relay energizes.

Options

250 series protector relays offer various customized options to suit individual requirements. Please consult factory.

- Time delay - internal fixed time delay before a trip occurs.
- Separate auxiliary supply - sometimes required to maintain a time delay or energized relay when the monitored signal fails.
- Adjustment ranges - different adjustment ranges are possible for the setpoint and differential controls.
- Relay operation - standard models are fail safe, but the relays can be customized to energize or de-energize on trip.

Product Codes

Relay	Protection	ANSI No.	Catalog No.
Single phase	Under voltage 75-100%	27	252-PVU
Single phase	Over voltage 100-125%	59	252-PVO
Single phase	Under and over voltage	27/59	253-PVB
3 phase 3 wire	Under voltage 75-100%	27	252-PVK
3 phase 3 wire	Over voltage 100-125%	59	252-PVA
3 phase 3 wire	Under and over voltage	27/59	253-PVM
3 phase 4 wire	Under voltage 75-100%	27	252-PVV
3 phase 4 wire	Over voltage 100-125%	59	252-PVP
3 phase 4 wire	Under and over voltage	27/59	253-PVE

Specify system voltage, frequency, and required options at time of ordering.

Provided by: K-Tech Inc. Ph:1 847 375 9524, Fx:1 847 375 9523
www.K-Tech.com info@k-tech.com

Features

- Single and 3 phase models
- Adjustable setpoint
- Adjustable differential
- Internal time delay
- LED trip indication
- Double pole relay contacts
- Automatic reset

Benefits

- Over and under voltage monitoring
- Start standby generators
- Operation of mains failure units
- Switching standby supplies
- Monitors genset AVR and excitation systems
- Nuisance tripping avoidance
- Customized options

Applications

- Marine panels
- Switchgear
- Distribution systems
- Generator sets
- Control panels
- Process control
- Motor protection
- Transformers
- Overload protection

Approvals

- UL , CSA , BV and ABS

250 Series DIN Rail and Wall Mounted Relays

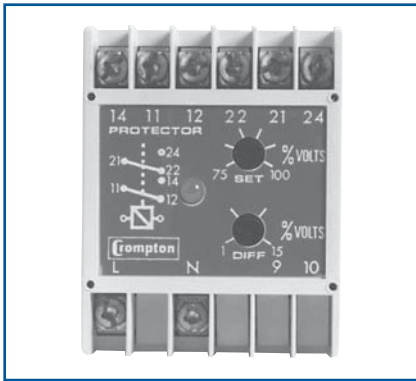

Specification – AC Voltage with Adjustable Differential

Nominal Voltage	100V, 110V, 120V, 208V, 220V, 270V, 280V, 400V, 415V or 440V
System Frequency	45/65Hz or 360/440Hz
Voltage Burden	0.3VA approx
Overload	1.2 x rating continuously, 1.5 x rating for 10 x seconds
Set Point Repeatability	>0.5% of full span
Differential (Hysteresis)	Adjustable range 1 to 15%
Trip Level Adjustment	Under Voltage: 75 to 100% Over Voltage: 100 to 125% of nominal input voltage
Time Delay	Factory preset up to 30 seconds
AC Auxiliary Supply Voltage	100V, 110V, 120V, 208V, 220V, 240V, 480V, ±20%
DC Auxiliary Supply Voltage	12V, 24V, 48V, 110V or 125V, ±15%. Max ripple 15%
Auxiliary Voltage Burden	4VA (max)
Output Relay	Double pole change over
Relay Contact Rating	AC: 240V 5A, non inductive DC: 24V, 5A resistive
Relay Mechanical Life	0.2 million operations at rated loads
Relay Reset	Automatic
Operating Temperature	0°C to +60°C (0°C to +40°C for UL models)
Storage Temperature	-20°C to + 70°C
Temperature Co-efficient	0.05% per °C
Interference Immunity	Electrical stress surge withstand and non-function to ANSI/IEEE C37 90a
Enclosure Style	DIN rail with wall mounting facility
Material	Flame retardant polycarbonate/ABS
Enclosure Integrity	IP50
Compliant With	EMC, LVD, Safety Standard IEC 414 UL File No: E113067 recognized up to 600V CSA File No: LR52592 up to 300V BV File No: 2650H-07427-AO PRSO BV (Model 253 only) ABS File No: 93-LD 17806-X (Model 253 only)
Model 252 Dimensions	55mm (2.2") wide x 70mm (2.8") high x 112mm (4.4") deep
Model 253 Dimensions	75mm (2.9") wide x 70mm (2.8") high x 112mm (4.4") deep
Weight	Model 252: 0.4Kg approx. Model 253: 0.6Kg approx

Connections

- 252-PVU
- 252-PVO
- 252-PVV
- 252-PVP
- 252-PVK
- 252-PVA

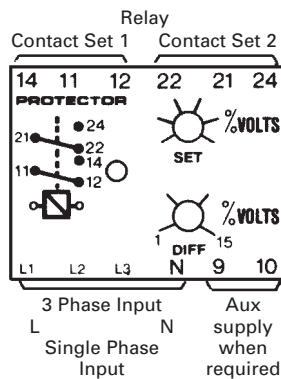

253-PVB

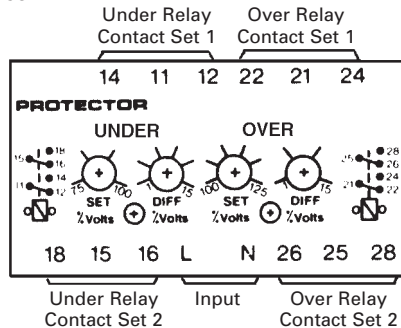

253-PVE 253-PVM

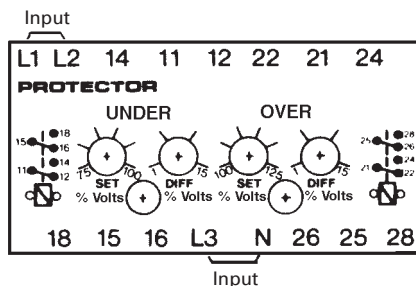

Note: The neutral connection is always used on 4 wire systems.

Dimensions

Model 252

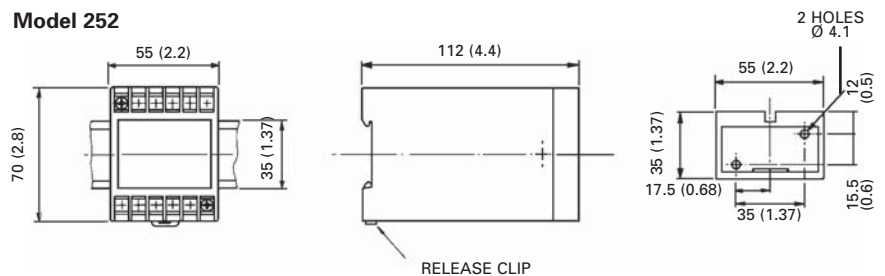

Model 253

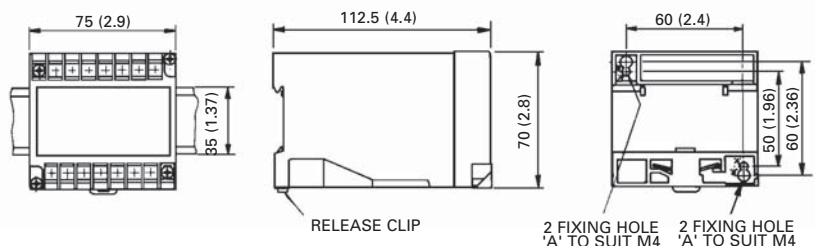

Provided by: K-Tech Inc. Ph:1 847 375 9524, Fx:1 847 375 9523
www.K-Tech.com info@k-tech.com

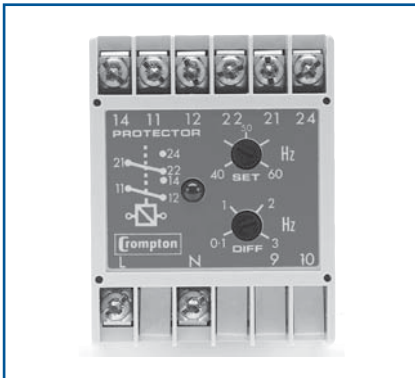

Features

- Adjustable setpoint
- Adjustable differential
- LED trip indication
- Double pole relay contacts
- Automatic reset

Benefits

- Over and under frequency monitoring
- Over and underspeed monitoring
- Start standby generators
- Operation of mains failure units
- Switching standby supplies
- Protection of control gear
- Nuisance tripping avoidance
- Customized options

Applications

- Marine panels
- Switchgear
- Distribution systems
- Generator sets
- Control panels
- Process control
- Motor protection
- Transformers
- Overload protection

Approvals

UL, CSA, BV and ABS

Frequency

Crompton frequency protectors give continuous surveillance of the monitored circuit. When the frequency moves outside the set point limit the relay will operate giving an alarm, control or tripping signal. An illuminated LED indicates when the relay is energized. Since speed is proportional to the frequency, this protector can be used to monitor over and underspeed, and to protect mains supplies, computer supplies, and standby supplies for Industrial, Hospital or Marine use.

Operation

Frequency protectors offer user adjustable frequency trip point (setpoint) and differential (hysteresis) settings. The setpoint adjustment range is centred around the nominal 50Hz, 60Hz or 400Hz system frequency. The differential setting adjustment can be used to reduce nuisance tripping if the measured signal is noisy or unstable. When the measured frequency moves outside the setpoint limit, the relay will operate, giving an alarm or initiation signal. As soon as the monitored frequency moves outside of the setpoint limit, a trip will occur. The units draw their operating power from the measuring inputs. Combined units offer under and over frequency trips in one compact unit. Single function units are also available.

Over Frequency Models

When the monitored frequency exceeds the setpoint, the relay will energize and the red LED will illuminate to indicate the trip condition. The relay will automatically reset once the monitored frequency falls below the setpoint minus the differential. When reset, the LED will extinguish and the relay de-energizes.

Under Frequency Models

When the monitored frequency falls below the setpoint, the relay will de-energize and the red LED will extinguish to indicate the trip condition. The relay will automatically reset once the monitored frequency rises above the setpoint plus the differential. When reset, the LED will illuminate and the relay energizes.

Options

250 series protector relays offer various customized options to suit individual requirements. Please consult factory.

- Adjustment ranges - different adjustment ranges are possible for the setpoint and differential controls.
- Time delay - internal fixed time delay before a trip occurs.
- Relay operation - standard models are fail safe, but the relays can be customized to energize or de-energize on trip.

Product Codes

Relay	Protection	ANSI No.	Catalog No.
Single phase	Under frequency	81U	252-PHU
Single phase	Over frequency	81O	252-PHO
Single phase	Under and over frequency	81O/U	253-PHD

Specify system voltage, frequency and required options at time of ordering.

Provided by: K-Tech Inc. Ph:1 847 375 9524, Fx:1 847 375 9523
www.K-Tech.com info@k-tech.com

250 Series DIN Rail and Wall Mounted Relays



Specification – Frequency

Nominal Voltage	100V, 110V, 120V, 208V, 220V, 230V, 240V, 277V, 380V, 400V, 415V, 440V or 480V ± 20%
System Frequency	40/60Hz, 50/70Hz or 360/440Hz
Voltage Burden	3VA
Overloads	1.2 x rating continuously, 1.5 x rating for 10 x seconds
Set Point Repeatability	>0.5% of full span
Differential (Hysteresis)	40/60Hz, 50/70Hz: Adjustable 0.1 to 3.0Hz 360/440Hz: Adjustable 10 to 30Hz
Output Relay	Double pole change over
Relay Contact Rating	AC: 240V 5A, non inductive DC: 24V, 5A resistive
Relay Mechanical Life	0.2 million operations at rated loads
Relay Reset	Automatic
Operating Temperature	0°C to +60°C (0°C to +40°C for UL models)
Storage Temperature	-20°C to + 70°C
Temperature Co-efficient	0.05% per °C
Interference Immunity	Electrical stress surge withstand and non-function to ANSI/IEEE C37 90a
Enclosure Style	DIN rail with wall mounting facility
Material	Flame retardant polycarbonate/ABS
Enclosure Integrity	IP50
Compliant With	EMC, LVD, Safety Standard IEC 414 UL File No: E113067 recognized up to 600V CSA File No: LR52592 up to 400Hz 300V BV File No: 2650H-07427-AO PRSO BV ABS File No: 93-LD 17806-X
Model 252 Dimensions	55mm (2.2") wide x 70mm (2.8") high x 112mm (4.4") deep
Model 253 Dimensions	75mm (2.9") wide x 70mm (2.8") high x 112mm (4.4") deep
Weight	Model 252: 0.4Kg approx. Model 253: 0.6Kg approx

Connections

252-PHU
252-PHO

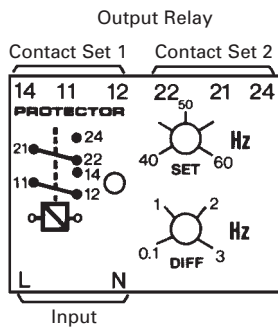

253-PHD

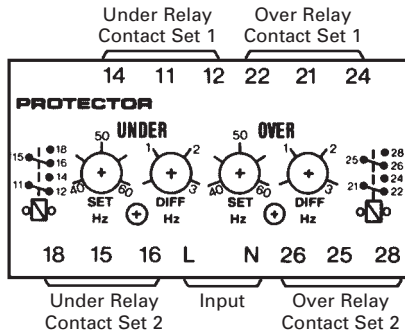

Dimensions

Model 252

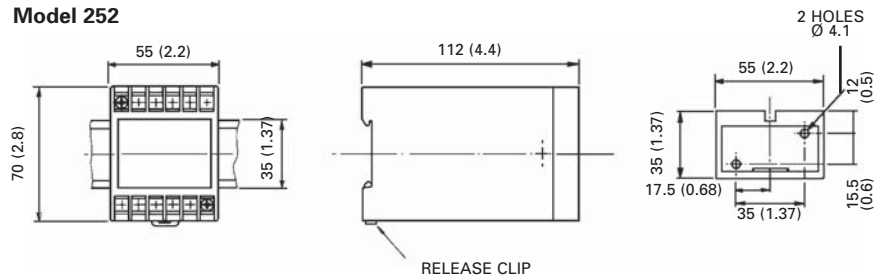

Model 253

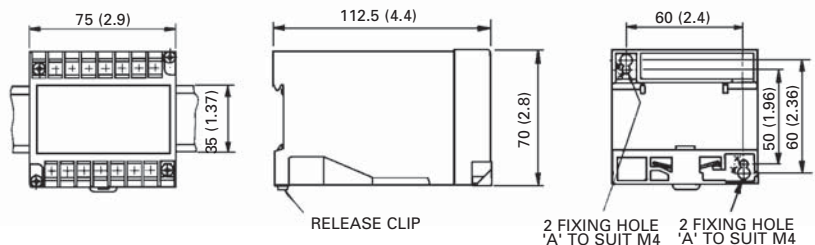

Provided by: K-Tech Inc. Ph:1 847 375 9524, Fx:1 847 375 9523
www.K-Tech.com info@k-tech.com



Features

- Adjustable setpoint
- Adjustable time delay
- Internal differential
- LED trip indication
- Double pole relay contacts
- Automatic reset

Benefits

- Over and under voltage monitoring
- Over and underspeed monitoring
- Start standby generators
- Operation of mains failure units
- Switching standby supplies
- Monitors genset AVR and excitation systems
- Nuisance tripping avoidance
- Customized options

Applications

- Switchgear
- Distribution systems
- Generator sets
- Control panels
- Process control
- Motor protection
- Transformers
- Overload protection

Approvals

- UL recognized

Combined Under/Over Voltage and Frequency

The 250 series combined voltage & frequency protectors provide continuous surveillance of the monitored circuit. When the voltage or frequency moves outside the set point limit the respective relay will operate giving an alarm, control or tripping signal. An illuminated LED indicates when the relay is energized. This protector can be used to protect against over and underspeed and over and under voltage.

Operation

Combined voltage and frequency protectors provide the most popular relay functions in one convenient package. The products offer user adjustable trip point (setpoint) for voltage and frequency, plus adjustable time delay settings. The setpoint adjustment range is 25%, operating between 75% and 100% of the nominal supply for under voltage, and between 100% and 125% for over voltage. The frequency setpoint adjustment range is centred around the nominal 50Hz, 60Hz or 400Hz system frequency. The time delay setting adjustment range is typically 0 to 10 seconds, although longer delays are available.

As soon as the monitored signal moves outside of the setpoint limit, the time delay is activated, after which a trip will occur. The time delay prevents the relay from tripping for predetermined period to prevent nuisance tripping. The products also feature an internal differential (hysteresis) setting of 1% to reduce nuisance tripping if the measured signal is noisy or unstable. The product is available for single phase systems only, and draws its operating power from the measuring input.

Over Voltage and Frequency

When the monitored value exceeds the setpoint and the time delay has elapsed, the relay will energize and the red LED will illuminate to indicate the trip condition.

Under Voltage and Frequency

The relay will de-energize after the time delay has elapsed, and the red LED will extinguish to indicate the trip condition.

Options

250 series protector relays offer various customized options to suit individual requirements. Please consult factory.

- Adjustment ranges - different adjustment ranges are possible for the setpoint and time delay controls.
- Differential - internally fixed value between 1% and 15%.
- Relay operation - standard models are fail safe, but the relays can be customized to energize or de-energize on trip.

Product Codes

Relay	Protection	ANSI No.	Catalog No.
Single phase	Over and under voltage, over and under frequency	27/59, 81O/U	256-PHV

Specify system voltage, frequency and required options at time of ordering.

Provided by: K-Tech Inc. Ph:1 847 375 9524, Fx:1 847 375 9523
www.K-Tech.com info@k-tech.com

250 Series DIN Rail and Wall Mounted Relays



Dimensions

Model 256

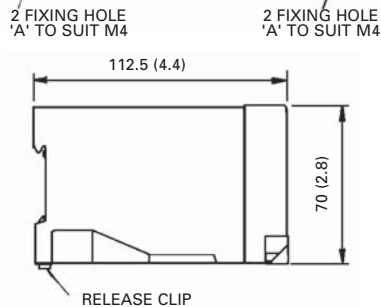
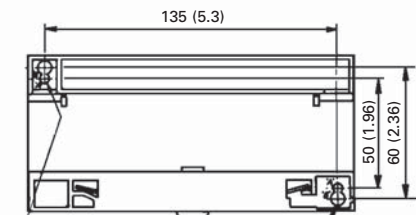
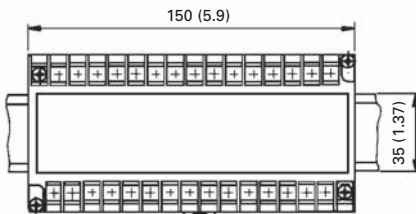

Specification – Combined Under/Over and Frequency

Nominal Voltage	100V, 110V, 120V, 208V, 220V, 270V, 280V, 400V, 415V or 440V
System Frequency	40/60Hz, 50/70Hz or 360/440Hz
Frequency Differential	Preset at 0.1Hz (10Hz for 400Hz unit)
Voltage Burden	3VA
Overloads	1.2 x rating continuously, 1.5 x rating for 10 x seconds
Set Point Repeatability	>0.5% of full span
Differential (Hysteresis)	Fixed internally at 1%
Trip Level Adjustment	Over voltage: 100 to 125% Under Voltage: 75 to 100% of nominal input voltage
Time Delay	Adjustable 1 to 30 seconds
Output Relay	4 independent double pole change over
Relay Contact Rating	AC: 240V 5A, non inductive DC: 24V, 5A resistive
Relay Mechanical Life	0.2 million operations at rated loads
Relay Reset	Automatic
Operating Temperature	0°C to +60°C (0°C to +40°C for UL models)
Storage Temperature	-20°C to + 70°C
Temperature Co-efficient	0.05% per °C
Interference Immunity	Electrical stress surge withstand and non-function to ANSI/IEEE C37 90a
Enclosure Style	DIN rail with wall mounting facility
Material	Flame retardant polycarbonate/ABS
Enclosure Integrity	IP50
Compliant With	EMC, LVD, Safety Standard IEC 414 UL File No: E113067 recognized up to 600V
Dimensions	150mm (5.9") wide x 70mm (2.8") high x 112mm (4.4") deep
Weight	1.0Kg approx

Connections

256-PHV

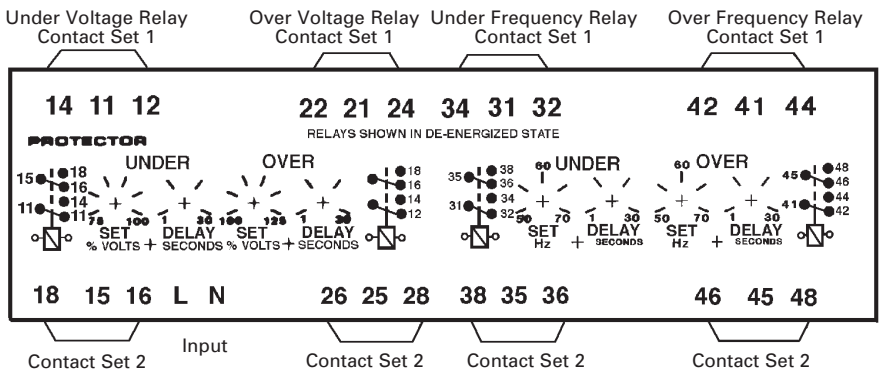

Provided by: K-Tech Inc. Ph:1 847 375 9524, Fx:1 847 375 9523
www.K-Tech.com info@k-tech.com

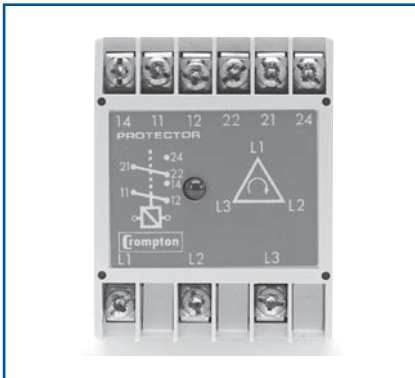

Phase Sequence and Phase Failure

The Crompton phase sequence and phase failure protector relays are designed to monitor the correct phase rotation or sequence of three phase, 3 or 4 wire supply systems and provide protection against incorrect phase sequence, loss of one phase, and under voltage.

Operation

Rotating machines are particularly vulnerable to incorrect phase sequence. Three phase motors can rotate in the wrong direction, potentially leading to physical damage or the risk of injury to personnel, yet voltage and current readings may appear normal. If one phase is lost because of a blown fuse, electric motors can continue to operate (single phasing) which can result in severe electrical or mechanical damage. For permanent installations, this relay should be used to monitor the incoming supply, protecting all equipment against incorrect connection at initial installation or after maintenance work. Rotating machines that cannot tolerate reverse rotation or pose significant risk to personnel under this condition should be individually protected with this relay. The possibility of incorrect supply connection is much more likely in portable equipment or marine applications.

The phase sequence and phase failure protectors continuously monitor the three phase supply. With the correct phase sequence applied, the front panel LED will illuminate and the output relay will be energized. An incorrect sequence or missing phase will de-energize the relay, and the LED will be extinguished. If the supply drops below 85% of its nominal voltage, this condition will also cause a trip.

Note: If one phase is lost due to a blown fuse, some loads can re-generate the missing voltage. This relay can be used as a phase failure relay providing the regenerated voltage in the open phase is less than 70% of the nominal supply voltage. If there is the possibility of a higher regenerated voltage, the phase balance relay 252-PSF should be used.

Features

- Three phase, 3 or 4 wire
- LED trip indication
- Double pole relay contacts
- Automatic reset

Benefits

- Monitoring of correct phase rotation
- Protection against incorrect phase sequence and loss of phase
- Under voltage monitoring
- Prevents reverse rotation of motor driven equipment
- Ensures correct engine rotation
- Protects portable electrical equipment

Applications

- Marine panels
- Switchgear
- Distribution systems
- Generator sets
- Control panels
- Process control
- Motor protection
- Transformers
- Overload protection

Approvals

- UL, CSA, BV and ABS

Product Codes

Relay	Protection	ANSI No.	Catalog No.
3 phase 3 or 4 wire	Phase sequence, under voltage 85%	47	252-PVR

Specify system voltage, frequency and required options at time of ordering.

Provided by: K-Tech Inc. Ph:1 847 375 9524, Fx:1 847 375 9523
www.K-Tech.com info@k-tech.com

250 Series DIN Rail and Wall Mounted Relays

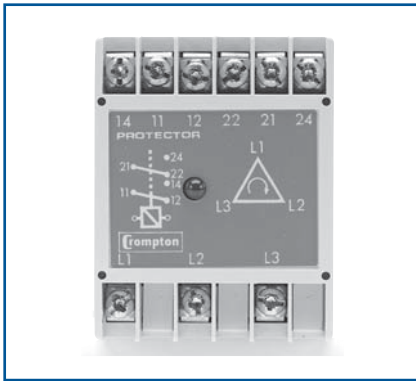

Specification – Phase Sequence and Phase Failure

Nominal Voltage	110V, 120V, 208V, 220V, 230V, 240V, 277V, 380V, 400V, 415V, 440V or 480V
Nominal Frequency	50, 60 or 400Hz
Voltage Burden	3VA approx.
Overload	1.2 x rating continuously, 1.5 x rating for 10 x seconds to symmetric
Trip Level Adjustment	Preset at 85% of nominal
Auxiliary Voltage Burden	4VA (max)
Output Relay	Double pole change over
Relay Contact Rating	AC: 240V 5A, non inductive DC: 24V, 5A resistive
Relay Mechanical Life	0.2 million operations at rated loads
Relay Reset	Automatic
Operating Temperature	0°C to +60°C (0°C to +40°C for UL models)
Storage Temperature	-20°C to + 70°C
Temperature Co-efficient	0.05% per °C
Interference Immunity	Electrical stress surge withstand and non-function to ANSI/IEEE C37 90a
Enclosure Style	DIN rail with wall mounting facility
Material	Flame retardant polycarbonate/ABS
Enclosure Integrity	IP50
Compliant With	EMC, LVD, US Safety Standard IEC 414 UL File No: E113067 recognized up to 600V CSA File No: LR52592 up to 300V BV File No: 2650H-07427-AO PRSO BV ABS File No; 93-LD 17806-X
Model 252 Dimensions	55mm (2.2") wide x 70mm (2.8") high x 112mm (4.4") deep
Weight	0.4Kg approx.

Connections

252-PVR

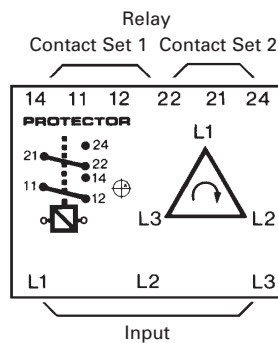

Note: No neutral connection is required.

Dimensions

Model 252

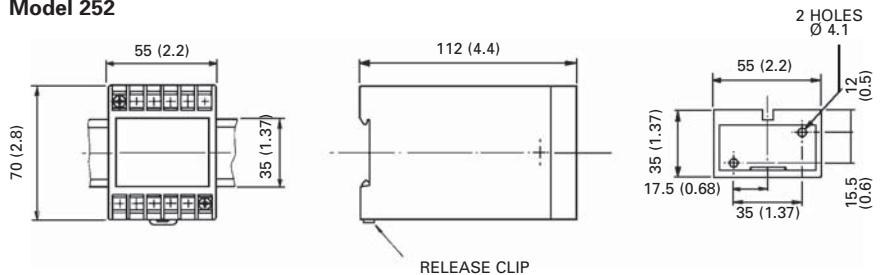

Provided by: K-Tech Inc. Ph:1 847 375 9524, Fx:1 847 375 9523
www.K-Tech.com info@k-tech.com

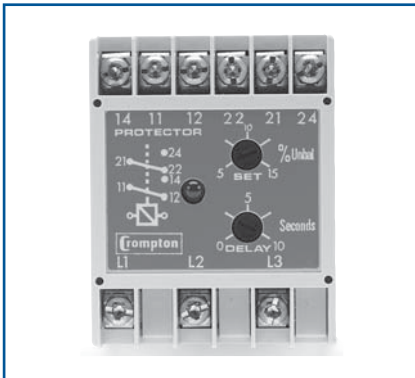

Phase Balance

The 250 series phase balance protector module provides continuous surveillance of a 3 phase, 3 or 4 wire system and monitors the correct phase rotation or sequence of three phase supply systems. The module protects against phase loss, reversal or sequence, phase unbalance, and system under voltage.

Operation

Rotating machines are particularly vulnerable to incorrect phase sequence. Three phase motors can rotate in the wrong direction, potentially leading to physical damage or the risk of injury to personnel, yet voltage and current readings may appear normal. If one phase is lost because of a blown fuse, electric motors can continue to operate (single phasing) which can result in severe electrical or mechanical damage. This relay has the added advantage that it will detect the phantom or regenerated phase that can be caused by a single phase failure on some equipment or when running motors at low load levels.

An unbalanced supply voltage can lead to temperature rises in motors. An unbalance voltage as little as 10% can increase operating temperature to 150% of normal. For permanent installations, this relay should be used to monitor the incoming supply, protecting all equipment against incorrect connection at initial installation or after maintenance work. Rotating machines that cannot tolerate reverse rotation or pose significant risk to personnel under this condition should be individually protected with this relay. The possibility of incorrect supply connection is much more likely in portable equipment or marine applications.

The protector continuously monitors the three phase supply. With the correct phase sequence applied and all three voltages balanced within the required limits, the front panel LED will illuminate and the output relay will be energized. An incorrect sequence, missing phase, out of balance or under voltage condition will de-energize the relay, and the LED will be extinguished.

The setpoint control allows adjustment of the voltage matching between 5% and 15%. The time delay function operates only for the voltage unbalance condition. The delay can be used to prevent nuisance tripping due to short term unbalance situations. Incorrect phase rotation, a missing phase or an under voltage condition trip the relay immediately.

Product Codes

Relay	Protection	ANSI No.	Catalog No.
3 phase 3 or 4 wire	Phase loss and unbalance 5 - 15%	47	252-PSF
3 phase 3 or 4 wire	Phase loss, unbalance and under voltage 5-15%	47/27	252-PSG

Specify system voltage, frequency and required options at time of ordering.

Features

- Three phase, 3 or 4 wire
- Adjustable setpoint
- Adjustable time delay
- Internal differential
- LED trip indication
- Double pole relay contacts
- Automatic reset

Benefits

- Monitoring of correct phase rotation
- Protects against phantom or regenerated phase voltage
- Protection against phase loss, reversal or sequence
- Under voltage and unbalanced voltage monitoring
- Prevents reverse rotation of motor driven equipment
- Ensures correct engine rotation
- Protects portable electrical equipment
- Nuisance tripping avoidance

Applications

- Marine panels
- Switchgear
- Distribution systems
- Generator sets
- Control panels
- Process control
- Motor protection
- Transformers
- Overload protection

Approvals

- UL, CSA, BV and ABS

Provided by: K-Tech Inc. Ph:1 847 375 9524, Fx:1 847 375 9523
www.K-Tech.com info@k-tech.com

250 Series DIN Rail and Wall Mounted Relays

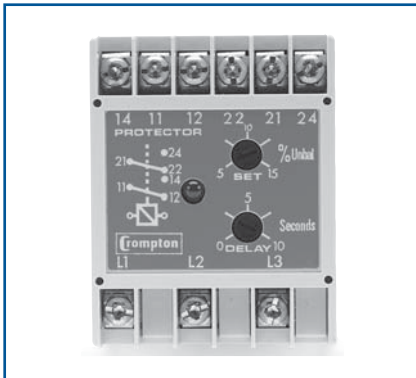

Specification – Phase Balance

Nominal Voltage	110V, 120V, 208V, 220V, 230V, 240V, 277V, 380V, 400V, 415V, 440V or 480V
System Frequency	50 or 60Hz
Voltage Burden	3VA approx.
Overload	1.2 x rating continuously, 1.5 x rating for 10 x seconds
Set Point Repeatability	>0.5% of full span
Under Voltage Setpoint	Preset at 15% of nominal voltage. Other values 10 to 30% to order (Model 252-PSG only)
Trip Level Adjustment	Phase unbalance adjustable 5 to 15%
Time Delay	10 seconds as standard. Up to 30 seconds available
Auxiliary Voltage Burden	4VA (max)
Output Relay	Double pole change over
Relay Contact Rating	AC: 240V 5A, non inductive DC: 24V, 5A resistive
Relay Mechanical Life	0.2 million operations at rated loads
Relay Reset	Automatic
Operating Temperature	0°C to +60°C (0°C to +40°C for UL models)
Storage Temperature	-20°C to + 70°C
Temperature Co-efficient	0.05% per °C
Interference Immunity	Electrical stress surge withstand and non-function to ANSI/IEEE C37 90a
Enclosure Style	DIN rail with wall mounting facility
Material	Flame retardant polycarbonate/ABS
Enclosure Integrity	IP50
Compliant With	EMC, LVD, Safety Standard IEC 414 UL File No: E113067 recognized up to 600V CSA File No: LR52592 up to 600V BV File No: 2650H-07427-AO PRSO BV ABS File No; 93-LD 17806-X
Model 252 Dimensions	55mm (2.2") wide x 70mm (2.8") high x 112mm (4.4") deep
Weight	0.4Kg approx.

Connections

252-PSF
252-PSG

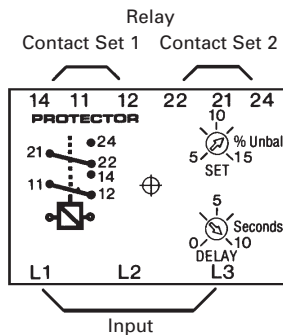

Note: Neutral connection not required

Dimensions

Model 252

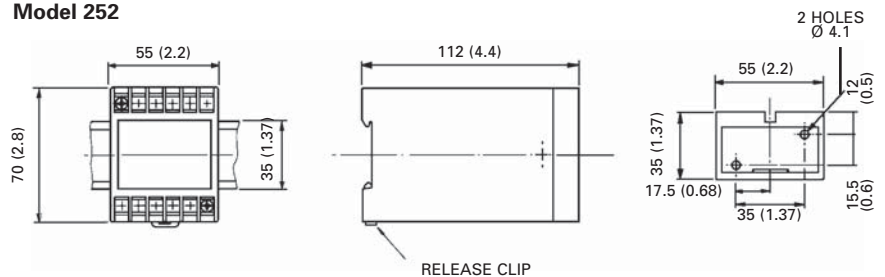

Provided by: K-Tech Inc. Ph:1 847 375 9524, Fx:1 847 375 9523
www.K-Tech.com info@k-tech.com



Features

- Three phase, 3 or 4 wire
- Adjustable setpoint
- Adjustable time delay
- Internal differential
- LED trip indication
- Double pole relay contacts
- Automatic reset

Benefits

- Current and power factor measurement
- Protects generators against 'motoring'
- Detects reverse power under fault conditions
- Customized options
- Nuisance tripping avoidance

Applications

- Marine panels
- Switchgear
- Distribution systems
- Generator sets
- Control panels
- Process control
- Motor protection
- Transformers
- Overload protection

Approvals

- UL, CSA, BV and ABS

Reverse Power (Current)

The reverse power protector provides continuous surveillance for A.C. generators operating in parallel or for boosting mains supplies. On site adjustment of the trip point and time delay ensures accurate protection against 'motoring' in the event of engine failure and prevents tripping from surges during synchronizing.

Operation

Reverse power protectors provide continuous surveillance of AC generators against motoring. Reverse power relays are used to detect the failure of the prime mover (engine) when active energy (Watts) flows into the generator causing rotation - the set will operate like an electric motor, which can cause significant mechanical damage. This relay offers an adjustable reverse power setpoint between 2% and 20% of nominal power, and time delay adjustment range of 0 to 20 seconds.

As soon as the reverse power level increases above the setpoint limit, the time delay is activated, after which a trip will occur. The time delay prevents the relay from tripping for a predetermined period to prevent nuisance tripping. The products also feature an internal differential (hysteresis) setting of 1% to reduce nuisance tripping if the measured signal is noisy or unstable. These units are powered from the measuring supply.

The protector relay approximates the power level in the system by measuring current and power factor, but does not actually measure the system voltage. When the reverse power level exceeds the setpoint, the time delay is started. When the time has elapsed, the relay will energize and the red LED will illuminate to indicate the trip condition. The relay will automatically reset once the power level falls below the setpoint minus the differential, the LED will extinguish and the relay de-energizes. The time delay is not active when resetting. The reverse power level will trip as expected at the calibrated point for unity power factor, however, the system power factor does affect the trip point calibration. The relay becomes more sensitive at lagging power factors, as almost all systems exhibit inductance. At leading power factors, this relay is less sensitive.

Setting Up

The "% set" potentiometer trimmer on the front label is calibrated as a percentage of the input current rating e.g. of 5A, and not of the forward kW. Adjust the "% set" trimmer to the required tripping value, 7.5% to 10% is normal. Setting accuracy can be checked by reversing the current lead connections and, with forward power, measuring the trip point value on a suitable ammeter (reconnect leads on completion). Adjust the 'Delay' to the required time delay, 10 seconds is normally adequate.

Options

250 series protector relays offer various customized options to suit individual requirements. Please consult factory.

- Adjustment ranges - different adjustment ranges are possible for the setpoint and time delay controls.
- Relay operation - standard models are fail safe, but the relays can be customized to de-energize on trip.

Product Codes

Relay	Protection	ANSI No.	Catalog No.
Single phase or 3 phase 4 wire	Reverse power 2 – 20%	32	256-PAS
Single phase or 3 phase 4 wire push to test	Reverse power 2 – 20%	32	256-PAQ
3 phase 3 wire push to test	Reverse power 2 – 20%	32	256-PAR
3 phase 3 wire	Reverse power 2 – 20%	32	256-PAT

Specify system voltage, frequency and required options at time of ordering.

Provided by: K-Tech Inc. Ph:1 847 375 9524, Fx:1 847 375 9523
www.K-Tech.com info@k-tech.com

250 Series DIN Rail and Wall Mounted Relays



Dimensions

Model 256

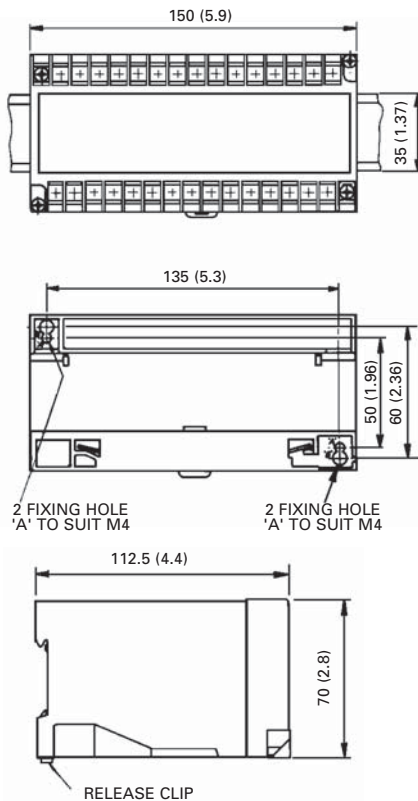

Specification – Reverse Power (Current)

Nominal Voltage	100V, 110V, 120V, 220V, 230V, 240V, 277V, 380V, 400V, 415V, 440V or 480V
Nominal Current	5A or 2, 3, 4, 6, 8 and 10A
System Frequency	50, 60 or 400Hz
Burden	Voltage: 3VA maximum Current: 2VA maximum
Current Overload	2 x rating continuously, 10 x rating for 3 seconds
Voltage Overload	1.2 x rating continuously, 1.5 x rating for 10 seconds
Monitoring Range	Power Factor: 0.5 inductive/unity/0.2 capacitive Current: 20 to 100% of nominal input
Set Point Repeatability	>0.5% of full span
Differential (Hysteresis)	Preset at 1%
Trip Level Adjustment	2 to 20%. Customized adjustment available.
Time Delay Adjustable	0 to 20 seconds
AC Auxiliary Supply Voltage	100V, 110V, 120V, 208V, 220V, 240V, 480V, ±20%
Auxiliary Voltage Burden	4VA (max)
Output Relay	Double pole change over
Relay Contact Rating	AC: 240V 5A, non inductive DC: 24V, 5A resistive
Relay Mechanical Life	0.2 million operations at rated loads
Relay Reset	Automatic
Operating Temperature	0°C to +60°C (0°C to +40°C for UL models)
Storage Temperature	-20°C to + 70°C
Temperature Co-efficient	0.05% per °C
Interference Immunity	Electrical stress surge withstand and non-function to ANSI/IEEE C37 90a
Enclosure Style	DIN rail with wall mounting facility
Material	Flame retardant polycarbonate/ABS
Enclosure Integrity	IP50
Compliant With	EMC, LVD, Safety Standard IEC 414 UL File No: E113067 recognized up to 600V CSA File No: LR52592 up to 300V BV File No: 2650H-07427-AO PRSO BV ABS File No; 93-LD 17806-X
Dimensions	150mm (5.9") wide x 70mm (2.8") high x 112mm (4.4") deep
Weight	1.0kg approx.

Connections

256-PAS
256-PAT
256-PAQ
256-PAR

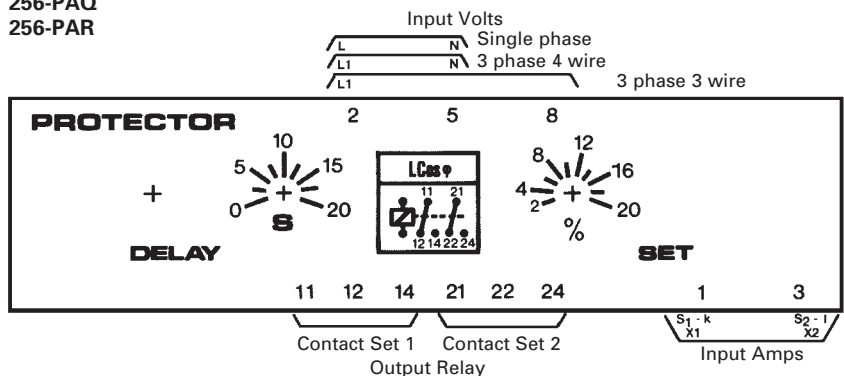

Note: Only one CT connection is required, from the same phase as the voltage connection to terminal 2.

Provided by: K-Tech Inc. Ph:1 847 375 9524, Fx:1 847 375 9523
www.K-Tech.com info@k-tech.com



Synchro-Check (paralleling)

The synchro-check relay can be used to assist in the semi-automatic paralleling of two AC power systems. The volt-free relay contacts change state when the voltage level, phase relationship and frequency are within the selected synchronizing limits. Connecting two electrical systems that are not closely matched can cause expensive damage and disturbance to the electrical system. Using this relay will ensure that damage will not occur.

Operation

As part of a manual control system, the operator will make adjustments to the generator voltage (excitation) and frequency (engine speed) using a synchroscope or lamps, and will then attempt to manually close the breaker. This synchro check protector will qualify that the two systems are closely matched before permitting the breaker to close. As part of an automatic synchronizing arrangement, this relay can be used as an independent backup or checking device to ensure the two systems are suitably matched before the breaker can close.

Features

- Single phase or three phase, 3 or 4 wire
- Live and dead bus versions
- Adjustable setpoint
- LED trip indication
- Volt free relay contacts

Benefits

- Monitors voltage phase displacement and frequency of 2 supplies
- Frequency matching
- Voltage matching
- Phase angle matching
- Synchronization of Gen-Bus and Bus-Bus
- Monitors auto synchronizing systems
- Assists in manual synchronization

Applications

- Marine panels
- Switchgear
- Distribution systems
- Generator sets
- Co-generation
- Control panels

Approvals

- UL, BV and ABS

Model 256-PLL

The relay continuously monitors the voltage, phase displacement and frequency of two supplies. A single setpoint adjustment permits selection of suitable matching, and a red LED illuminates when the relay is energized, indicating that the two supplies are well matched and it is safe to close the breaker.

Model- 256-PLD

This version operates in the same way as model 256-PLL, but includes an additional dead bus detection function. If there is a requirement for a continuous supply or emergency power, then the generator can be connected without synchronizing, thus ensuring continuity of supply. The absence of bus voltage will cause the relay to energize.

Product Codes

Relay	Protection	ANSI No.	Catalog No.
Single phase, or 3 phase 3 or 4 wire	Phase angle and voltage	25	256-PLL
Single phase, or 3 phase 3 or 4 wire	Phase angle and voltage Dead bus	25	256-PLD

Specify system voltage, frequency and required options at time of ordering.

Provided by: K-Tech Inc. Ph:1 847 375 9524, Fx:1 847 375 9523
www.K-Tech.com info@k-tech.com

250 Series DIN Rail and Wall Mounted Relays



Dimensions

Model 256

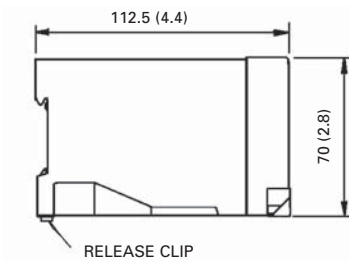
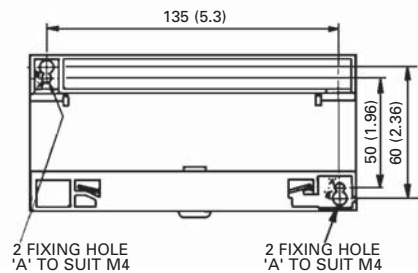
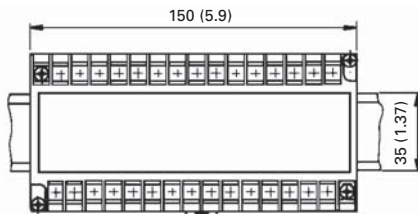

Specification – Synchro-Check (paralleling)

Nominal Voltage	100V, 110V, 120V, 208V, 220V, 230V, 240V, 277V, 380V, 400V, 415V, 440V or 480V
System Frequency	45, 50, 55, 60 or 65Hz
Burden	Bus: 2VA Generator: 4VA
Overload	-25 to +30% of the nominal voltage
Set Point Repeatability	>0.5% of full span
Differential (Hysteresis)	Preset at 1%. Values 1% to 10% available on request
Trip Level	10 to 30% of the nominal voltage. 6° to 20° electrical adjustment
Output Relay	1 pair NO (normally open), 1 pair NC (normally closed) 2 pair NO and 2 pair NC available on request
Relay Contact Rating	AC: 240V 5A, non inductive DC: 24V, 5A resistive
Relay Mechanical Life	0.2 million operations at rated loads
Relay Reset	Automatic
Operating Temperature	0°C to +60°C (0°C to +40°C for UL models)
Storage Temperature	-20°C to +70°C
Temperature Co-efficient	0.05% per °C
Interference Immunity	Electrical stress surge withstand and non-function to ANSI/IEEE C37 90a
Enclosure Style	DIN rail with wall mounting facility
Material	Flame retardant polycarbonate/ABS
Enclosure Integrity	IP50
Compliant With	EMC, LVD, Safety Standard IEC 414 UL File No: E113067 recognized up to 600V BV File No: 2650H-07427-AO PRSO BV ABS File No: 93-LD 17806-X
Dimensions	150mm (5.9") wide x 70mm (2.8") high x 112mm (4.4") deep
Weight	1.0kg approx.

Connections

256-PLL 256-PLD

System	Generator Connections	Busbar Connections
3 phase 4 wire	1 2	3 4
3 phase 3 wire	L1 N	L1 N
1 phase 2 wire	L1 L2	L1 L2
	L1 N	L1 N

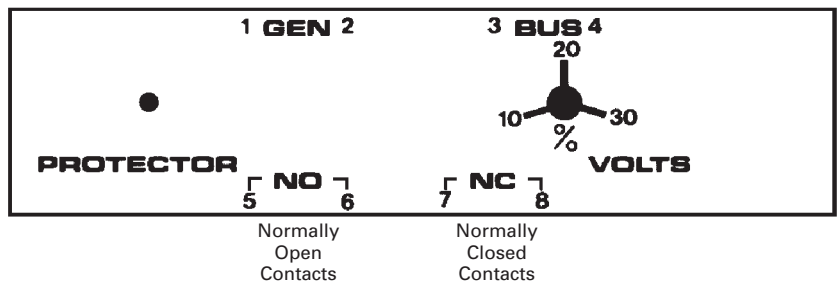

Provided by: K-Tech Inc. Ph:1 847 375 9524, Fx:1 847 375 9523
www.K-Tech.com info@k-tech.com

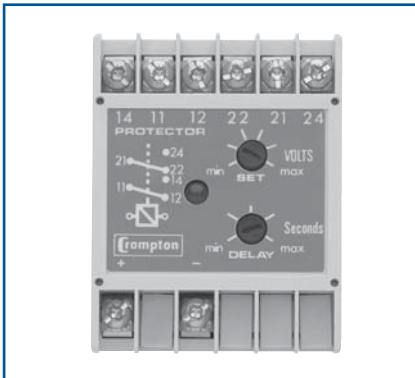

Features

- Adjustable setpoint
- Adjustable time delay
- Internal differential
- LED trip indication
- Automatic reset
- Double pole relay contacts

Benefits

- Over and under voltage monitoring
- Monitors correct terminal voltage on battery supplies
- Monitors charging voltage on battery chargers
- Battery level control
- Nuisance tripping avoidance
- Customized options

Applications

- Marine panels
- Switchgear
- Distribution systems
- Generator sets
- Control panels
- Process control
- Overload protection

Approvals

- UL recognized

D.C. Voltage

DC voltage protectors provide continuous surveillance of the monitored voltage circuit, typically a battery supply or charging circuit. When the measured voltage moves outside the set-point limits, the relay will operate after the selected time delay or differential, giving an alarm and/or initiation signal. The protectors offer protection for under voltage, over voltage and battery level control.

Operation

DC voltage protectors offer user adjustable trip point (setpoint) and time delay settings. The time delay setting adjustment range is typically 0 to 10 seconds, although longer delays up to 30 seconds are available. As soon as the monitored signal moves outside of the setpoint limit, the time delay is activated, after which a trip will occur. The time delay prevents the relay from tripping for a predetermined period to prevent nuisance tripping. The products also feature an internal differential (hysteresis) setting of 1% to reduce nuisance tripping if the measured signal is noisy or unstable. The units draw their operating power from the measuring inputs.

Over Voltage Models

When the monitored voltage exceeds the setpoint, the time delay is started. When the time has elapsed, the relay will energize and the red LED will illuminate to indicate the trip condition. The relay will automatically reset once the monitored voltage falls below the setpoint minus the differential. When reset, the LED will extinguish and the relay de-energizes. The time delay is not active when resetting.

Under Voltage Models

When the monitored voltage falls below the setpoint, the time delay is started. When the time has elapsed, the relay will de-energize and the red LED will extinguish to indicate the trip condition. The relay will automatically reset once the monitored voltage rises above the setpoint plus the differential. When reset, the LED will illuminate and the relay energizes. The time delay is not active when resetting.

Options

250 series protector relays offer various customized options to suit individual requirements. Please consult factory.

- Adjustment ranges - different adjustment ranges are possible for the setpoint and time delay controls.
- Differential - Internally fixed value between 1% and 15%.
- Relay operation - standard models are fail safe, but the relays can be customized to energize or de-energize on trip.

Product Codes

Relay	Protection	ANSI No.	Catalog No.
DC Voltage	Under voltage external time delay	27	252-PDU
DC Voltage	Under voltage differential	27	252-PDE
DC Voltage	Over voltage external time delay	59	252-PDO
DC Voltage	Over and under voltage external time delay	27/59	253-PDC

Specify system voltage, frequency and required options at time of ordering.

Provided by: K-Tech Inc. Ph:1 847 375 9524, Fx:1 847 375 9523
www.K-Tech.com info@k-tech.com

250 Series DIN Rail and Wall Mounted Relays



Connections

252-PDU
252-PDO

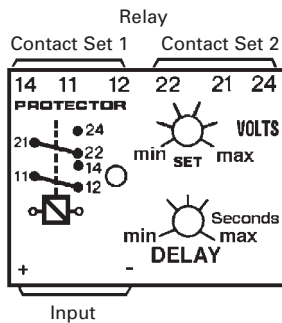

252-PDE

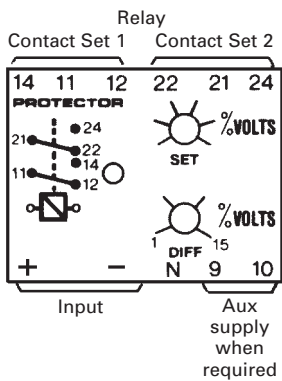

253-PDC

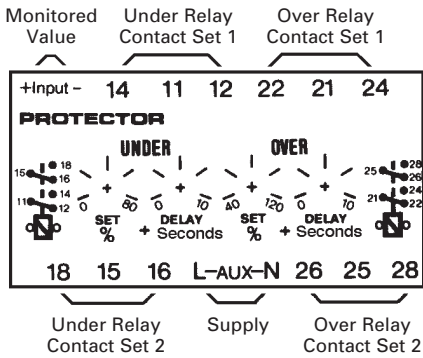

Specification – D.C. Voltage

Nominal Voltage	18 to 20V DC or 20 to 32V DC
Voltage Burden	<3VA
Overload	1.2 x rating continuously
Set Point Repeatability	>0.5% of full span
Differential (Hysteresis)	Models 252-PDU, 252-PDO & 253-PDC: Preset at 1%. Values 1% to 15% available on request Model 252-PDE: Adjustable 1 to 15%
Time Delay Adjustment	Models 252-PDU, 252-PDO & 253-PDC: 0-10, 0-20, 0-30 seconds Model 252-PDE: Factory pre-set up to 30 seconds
AC Auxiliary Supply Voltage	100V, 110V, 120V, 208V, 220V, 240V, 480V, ±20%
DC Auxiliary Supply Voltage	12V, 24V, 48V, 110V or 125V, ±15%. Max ripple 15%
Auxiliary Voltage Burden	4VA (max)
Output Relay	Double pole change over
Relay Contact Rating	AC: 240V 5A, non inductive DC: 24V, 5A resistive
Relay Mechanical Life	0.2 million operations at rated loads
Relay Reset	Automatic
Operating Temperature	0°C to +60°C (0°C to +40°C for UL models)
Storage Temperature	-20°C to + 70°C
Temperature Co-efficient	0.05% per °C
Interference Immunity	Electrical stress surge withstand and non-function to ANSI/IEEE C37 90a
Enclosure Style	DIN rail with wall mounting facility
Material	Flame retardant polycarbonate/ABS
Enclosure Integrity	IP50
Compliant With	EMC, LVD, Safety Standard IEC 414 UL File No: E113067 recognized up to 600V
Model 252 Dimensions	55mm (2.2") wide x 70mm (2.8") high x 112mm (4.4") deep
Model 253 Dimensions	75mm (2.9") wide x 70mm (2.8") high x 112mm (4.4") deep
Weight	Model 252: 0.4Kg approx. Model 253: 0.6Kg approx

Dimensions

Model 252

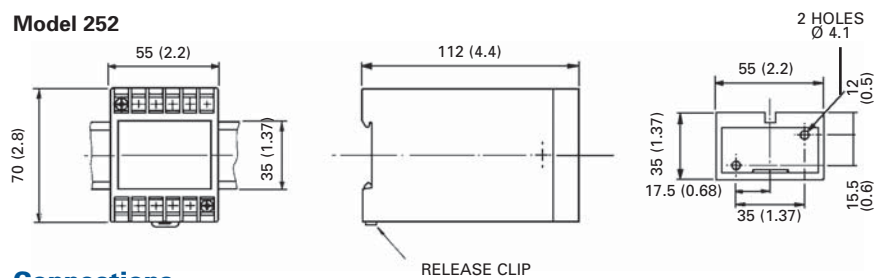

Connections

Model 253

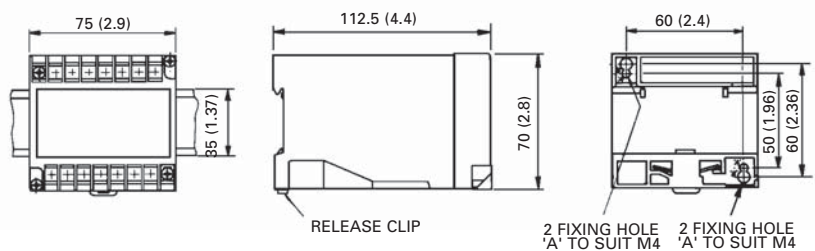

Provided by: K-Tech Inc. Ph:1 847 375 9524, Fx:1 847 375 9523
www.K-Tech.com info@k-tech.com

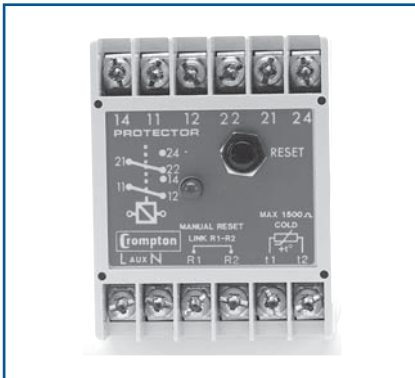

Features

- Trip range 2500 to 3500 ohms
- Reset range 1500 to 2300 ohms
- LED trip indication
- Automatic or manual reset options
- Double pole relay contacts

Benefits

- High temperature protection
- Sustained overload protection
- Single phasing protection
- Locked rotor protection
- Blocked ventilation protection

Applications

- Switchgear
- Distribution systems
- Generator sets
- Control panels
- Process control
- Motor protection
- Transformers
- Overload protection

Approvals

- UL and CSA

Thermistor Trip

Many motors, transformers and generators are fitted with positive temperature coefficient thermistor temperature sensors, the addition of a thermistor trip relay will provide full protection against sustained overload, single phasing, locked rotor, blocked ventilation and high ambient temperature. Thermistor trip relays continuously monitor the working temperature inside electrical equipment. When the temperature exceeds a safe limit, the relay can be used to shut equipment down until it regains a safe operating temperature.

Operation

Thermistors are simple low cost temperature sensors. The thermistor trip protector operates by de-energizing a relay when the thermistors detect a critical temperature condition. An illuminated green LED indicates when the temperature is within normal working limits. Any number of thermistors may be used in series connection providing the resistance at normal working temperature is less than 1500 ohms.

There are no user adjustments on this relay.

Model 252-PMT will automatically reset when temperature returns to normal. For Model 252-PMM, fitting a link between terminals R1 and R2 will latch the product in its tripped state when an over temperature condition is detected. The relay can be reset by pressing the front panel reset switch, opening the R1 - R2 link, or interrupting the auxiliary supply.

Product Codes

Relay	Protection	ANSI No.	Catalog No.
PTC Thermistors	Over temperature, manual reset	49	252-PMM
PTC Thermistors	Over temperature, automatic reset	49	252-PMT

Specify system voltage and required options at time of ordering.

Provided by: K-Tech Inc. Ph:1 847 375 9524, Fx:1 847 375 9523
www.K-Tech.com info@k-tech.com

250 Series DIN Rail and Wall Mounted Relays

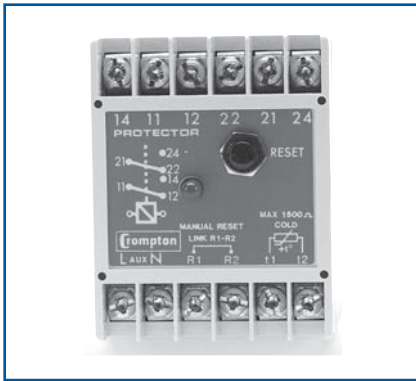

Specification – Thermistor Trip

Nominal Voltage	110V, 120V, 220V, 230V or 240V AC $\pm 20\%$.
Input	Positive temperature coefficient thermistors (series connected 1500 Ω at normal temperature)
System Frequency	50/60Hz
Voltage Burden	2VA approx
Overload	1.2 x rating continuously
Trip Level	2500 to 3500 Ω reset 1500 to 2300 Ω
AC Auxiliary Supply Voltage	100V, 110V, 120V, 208V, 220V, 240V, 480V, $\pm 20\%$
DC Auxiliary Supply Voltage	12V, 24V, 48V, 110V or 125V, $\pm 15\%$. Max ripple 15%
Auxiliary Voltage Burden	4VA (max)
Output Relay	Double pole change over
Relay Contact Rating	AC: 240V 5A, non inductive DC: 24V, 5A resistive
Relay Mechanical Life	0.2 million operations at rated loads
Relay Reset	Model 252-PMT: Automatic Model 252-PM: Manual
Operating Temperature	0°C to +60°C (0°C to +40°C for UL models)
Storage Temperature	-20°C to + 70°C
Temperature Co-efficient	0.05% per °C
Interference Immunity	Electrical stress surge withstand and non-function to ANSI/IEEE C37 90a
Enclosure Style	DIN rail with wall mounting facility
Material	Flame retardant polycarbonate/ABS
Enclosure Integrity	IP50
Compliant With	EMC, LVD, Safety Standard IEC 414 UL File No: E113067 recognized up to 600V CSA File No: LR52592 up to 300V
Model 252 Dimensions	55mm (2.2") wide x 70mm (2.8") high x 112mm (4.4") deep
Weight	0.4Kg approx.

Connections

252-PMT

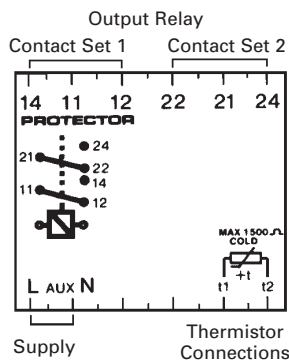

252-PM

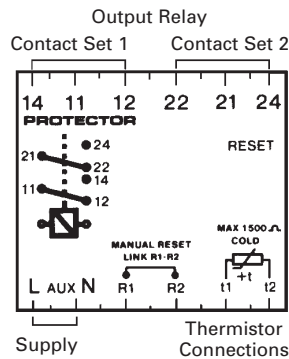

Dimensions

Model 252

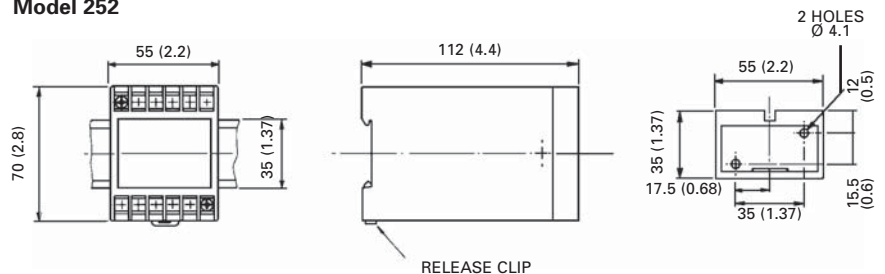

Provided by: K-Tech Inc. Ph:1 847 375 9524, Fx:1 847 375 9523
www.K-Tech.com info@k-tech.com



Hot Spot 3 Temperature Relay

The Hot Spot 3 relay accepts up to three inputs from resistance temperature detectors (RTD) and provides up to three user adjustable trip points which can be used to initiate alarms, cooling systems or shutdown. The relay is ideally suited for the protection of electric motor windings, transformers, generator windings and bearing temperature. The analog output can be used for remote monitoring of high temperatures.

Operation

RTD temperature sensors are often fitted inside electric motors to detect hot spots in the windings or the bearings. RTD sensors are popular because they offer a good accuracy for a reasonable price. The same sensors can be used inside transformers, generator sets, gas turbines or as part of a process control system. Hot spots can be caused by many conditions, such as overloads, over voltage, unbalanced supply, worn bearings, ineffective cooling, poor ventilation, shorted turns, insulation breakdown, single phasing etc.

The Hot Spot 3 protector continuously monitors the three RTD temperature sensors, and offers up to three user adjustable setpoints and relay contacts. These can be used to raise alarms, switch on cooling systems or shut down the effected equipment. The highest temperature is indicated with a yellow LED, and can be accurately measured or remotely displayed using the 0/1mA analog output signal.

The temperature is compared with the user adjustable setpoints. When the measured temperature exceeds the setpoint, the relay will de-energize, and a red LED illuminated to indicate the trip condition. When the temperature drops below the setpoint, the relay will reset to the energized condition, and the LED will extinguish. The range consists of three product models which offers one, two or three adjustable setpoints.

Features

- Up to 3 RTD inputs
- 1mA analog output
- 3 adjustable setpoints
- Internal differential
- LED trip indication
- Automatic reset
- 3 single pole relay contacts

Benefits

- Temperature monitoring
- Unbalanced supply protection
- Sustained overload protection
- Single phasing protection
- Blocked ventilation protection
- Protection against ineffective cooling
- Protection of bearing temperature

Applications

- Switchgear
- Distribution systems
- Generator sets
- Control panels
- Process control
- Motor monitoring
- Transformers
- Overload protection

Approvals

- UL recognized

Product Codes

Relay	Protection	ANSI No.	Catalog No.
3 RTD inputs	3 set points	49	256-PRA
3 RTD inputs	2 set points	49	256-PRB
3 RTD inputs	1 set point	49	256-PRC

When ordering please supply the following information:

- System voltage, frequency and required options.
- The type of temperature sensor being used, e.g. Platinum PT100.
- The maximum temperature or meter scale, e.g. 100% = 1mA = 150°C.
- The setpoint adjustment range, e.g. 0°C to 150°C.

Provided by: K-Tech Inc. Ph:1 847 375 9524, Fx:1 847 375 9523
www.K-Tech.com info@k-tech.com

250 Series DIN Rail and Wall Mounted Relays



Dimensions

Model 256

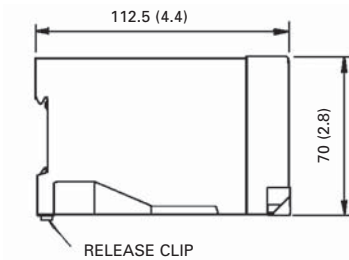
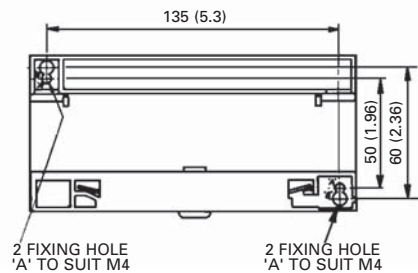
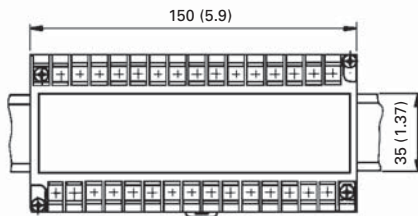

Specification – Hot Spot 3 Temperature Relay

Input	Up to 3 resistance temperature detectors (RTD). Either 10Ω copper or 100Ω platinum minimum span 100°C
Nominal Voltage	AC: 110V, 120V, 220V, 230V, or 240V ± 20% DC: Consult Factory
System Frequency	50/60Hz
Overload	1.2 x rating continuously
Set Point Repeatability	0.5% of full span
Differential (Hysteresis)	Preset at 2% of range
AC Auxiliary Supply Voltage	100V, 110V, 120V, 208V, 220V, 240V, 480V, ±20%
DC Auxiliary Supply Voltage	12V, 24V, 48V, 110V or 125V, ±15%. Max ripple 15%
Auxiliary Voltage Burden	4VA (max)
Analog Output	1mA into 0/4kΩ load
Output Relay	Single pole change over
Relay Contact Rating	AC: 240V 5A, non inductive DC: 24V, 5A resistive
Relay Mechanical Life	0.2 million operations at rated loads
Relay Reset	Automatic
Operating Temperature	0°C to +60°C (0°C to +40°C for UL models)
Storage Temperature	-20°C to + 70°C
Temperature Co-efficient	0.05% per °C
Interference Immunity	Electrical stress surge withstand and non-function to ANSI/IEEE C37 90a
Enclosure Style	DIN rail with wall mounting facility
Material	Flame retardant polycarbonate/ABS
Enclosure Integrity	IP50
Compliant With	EMC, LVD, Safety Standard IEC 414 UL File No: E113067 recognized up to 600V
Dimensions	150mm (5.9") wide x 70mm (2.8") high x 112mm (4.4") deep
Weight	1.0kg approx.

Connections

256-PRA
256-PRB
256-PRC

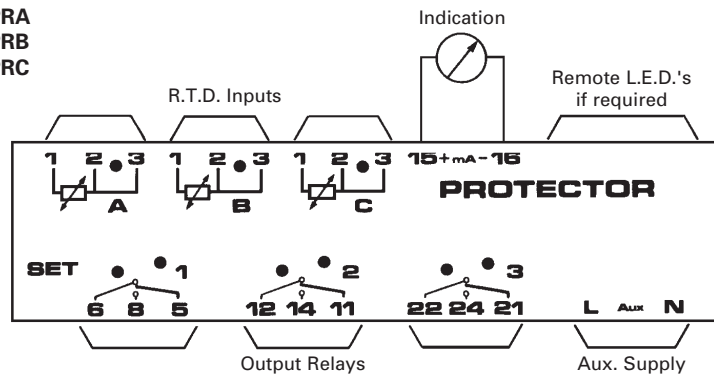

Provided by: K-Tech Inc. Ph:1 847 375 9524, Fx:1 847 375 9523
www.K-Tech.com info@k-tech.com



Hot Spot 6 Temperature Relay

The Hot Spot 6 protector is a temperature trip relay accepting up to six inputs from resistance temperature detector (RTD) elements and provides one user adjustable trip point which can be used to initiate alarms, cooling or shutdown when the monitored temperature exceeds the set limit. The relay is ideally suited for the protection of electric motor windings, transformers, generator windings and bearing temperature.

Operation

RTD temperature sensors are often fitted inside electric motors to detect hot spots in the windings or bearings. RTD sensors are popular because they offer a good accuracy for a reasonable price. The same sensors can be used inside transformers, generator sets, gas turbines or as part of a process control system. Hot spots can be caused by many conditions, such as overloads, over voltage, unbalanced supply, worn bearings, ineffective cooling, poor ventilation, shorted turns, insulation breakdown, single phasing etc.

The Hot Spot 6 protector continuously monitors the six RTD temperature sensors, and offers a user adjustable setpoint and relay contacts. This can be used to raise alarms, switch on cooling systems or shut down the effected equipment. The highest of the six temperatures is indicated with a red LED. This temperature is compared with the user adjustable setpoint. When the measured temperature exceeds the setpoint, the relay will de-energize, and the red LED illuminates to indicate the trip condition. When the temperature drops below the setpoint, the relay will reset to the energized condition, and a green LED will illuminate to indicate 'Safe' condition.

Features

- Up to 6 RTD inputs
- Adjustable setpoint
- Internal differential
- LED trip indication
- Automatic reset
- Single pole relay contacts

Benefits

- Unbalanced supply protection
- Sustained overload protection
- Single phasing protection
- Blocked ventilation protection
- Protection against ineffective cooling
- Protection of bearing temperature

Applications

- Switchgear
- Distribution systems
- Generator sets
- Control panels
- Process control
- Motor monitoring
- Transformers
- Overload protection

Approvals

- UL recognized

Product Codes

Relay	Protection	ANSI No.	Catalog No.
6 RTD inputs	1 setpoint	49	256-PCC

When ordering please supply the following information:

- System voltage, frequency and required options.
- The type of temperature sensor being used, e.g. Platinum PT100.
- The maximum temperature or meter scale, e.g. 100% = 1mA = 150°C
- The setpoint adjustment range, e.g. 0°C to 150°C.

Provided by: K-Tech Inc. Ph:1 847 375 9524, Fx:1 847 375 9523
www.K-Tech.com info@k-tech.com

250 Series DIN Rail and Wall Mounted Relays



Specification – Hot Spot 6 Temperature Relay

Input	Up to 6 resistance temperature detectors (RTD). Either 10Ω copper or 100Ω platinum minimum span 100°C
Nominal Voltage	AC: 110V, 120V, 220V, 230V, or 240V ± 20% DC: Consult Factory
System Frequency	50/60Hz
Voltage Burden	6VA maximum
Overload	1.2 x rating continuously
Set Point Repeatability	Within 1°C
Differential (Hysteresis)	4°C of nominal
Trip Level Adjustment	100°C (eg: 50 to 150°C, 100 to 200°C etc)
Time Delay	Typically 250ms
AC Auxiliary Supply Voltage	100V, 110V, 120V, 208V, 220V, 240V, 480V, ±20%
DC Auxiliary Supply Voltage	12V, 24V, 48V, 110V or 125V, ±15%. Max ripple 15%
Auxiliary Voltage Burden	4VA (max)
Output Relay	Single pole change over
Relay Contact Rating	AC: 240V 5A, non inductive DC: 24V, 5A resistive
Relay Mechanical Life	0.2 million operations at rated loads
Relay Reset	Automatic
Operating Temperature	0°C to +60°C (0°C to +40°C for UL models)
Storage Temperature	-20°C to + 70°C
Temperature Co-efficient	0.05% per °C
Interference Immunity	Electrical stress surge withstand and non-function to ANSI/IEEE C37 90a
Enclosure Style	DIN rail with wall mounting facility
Material	Flame retardant polycarbonate/ABS
Enclosure Integrity	IP50
Compliant With	EMC, LVD, Safety Standard IEC 414 UL File No: E113067 recognized up to 600V
Dimensions	150mm (5.9") wide x 70mm (2.8") high x 112mm (4.4") deep
Weight	1.0kg approx.

Dimensions

Model 256

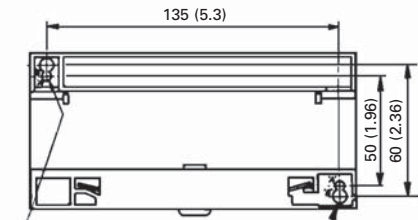
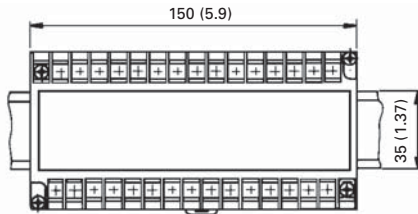

2 FIXING HOLE 'A' TO SUIT M4

2 FIXING HOLE 'A' TO SUIT M4

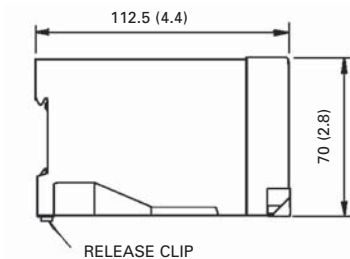

Connections

256-PCC

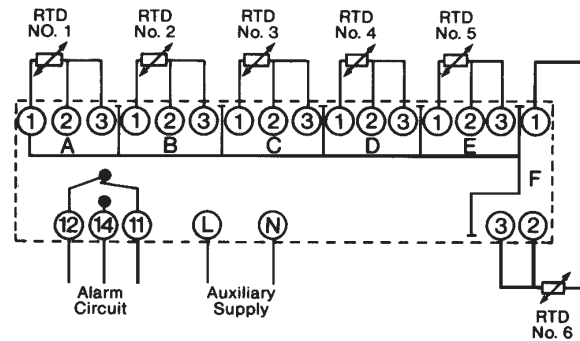

When used for less than 6 RTD inputs the unused terminals 1, 2 & 3 must be linked together.

Provided by: K-Tech Inc. Ph:1 847 375 9524, Fx:1 847 375 9523
www.K-Tech.com info@k-tech.com

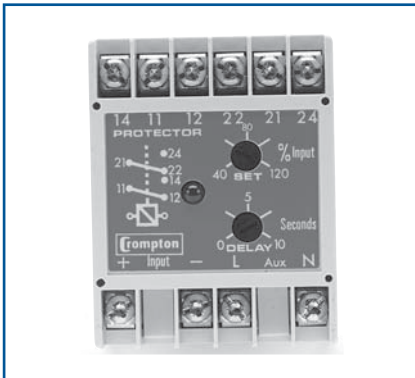

D.C. Millivolts / Thermocouple

The 250 series millivolt protectors provide continuous surveillance of high DC currents when used with current shunts, or can be used to monitor temperatures in conjunction with thermocouples. The protector incorporates a user adjustable trip and time delay which can be set to initiate an alarm when the input exceeds the desired level.

Operation

When used in conjunction with current shunts the millivolt protector can be used to monitor battery charging currents, current drain or over/under current. Monitoring of under / over temperature and detection of hotspots can be achieved in applications using thermocouples. All industry standard shunts, and all popular thermocouples are supported.

The millivolt protector relays offer user adjustable trip point (setpoint) and time delay settings. The time delay setting adjustment range is typically 0 to 10 seconds, although longer delays are available. As soon as the monitored signal moves outside of the setpoint limit, the time delay is activated, after which a trip will occur. The time delay prevents the relay from tripping for a predetermined period to prevent nuisance tripping. These products also feature an internal differential (hysteresis) setting of 1% to reduce nuisance tripping if the measured signal is noisy or unstable. These units require an auxiliary power supply.

Features

- High and low trip models
- Adjustable setpoint
- Adjustable time delay
- Internal differential
- LED trip indication
- Automatic reset
- Double pole relay contacts
- Supports all industry standard shunts and popular thermocouples

Benefits

- Under / Over temperature monitoring
- Under / Over current monitoring
- Monitoring of battery charging currents and current drain
- Detection of hotspots
- Nuisance tripping avoidance
- Customized options

Applications

- Switchgear
- Distribution systems
- Generator sets
- Control panels
- Process control
- Motor protection
- Transformers
- Overload protection

Approvals

- UL and CSA

'Over' High Trip Models

When the monitored signal exceeds the setpoint, the time delay is started. When the time has elapsed, the relay will energize and the red LED will illuminate to indicate the trip condition. The relay will automatically reset once the monitored signal falls below the setpoint minus the differential. When reset, the LED will extinguish and the relay de-energizes. The time delay is not active when resetting.

'Under' Low Trip Models

When the monitored signal falls below the setpoint, the time delay is started. When the time has elapsed, the relay will de-energize and the red LED will extinguish to indicate the trip condition. The relay will automatically reset once the monitored signal rises above the setpoint plus the differential. When reset, the LED will illuminate and the relay energizes. The time delay is not active when resetting.

Options

250 series protector relays offer various customized options to suit individual requirements. Please consult factory.

- Adjustment ranges - different adjustment ranges are possible for the setpoint and time delay controls.
- Differential - Internally fixed value between 1% and 15%.
- Relay operation - standard models are failsafe, but the relays can be customized to energize or de-energize on trip.
- Cold junction compensation available on request.

Product Codes

Relay	Protection	ANSI No.	Catalog No.
DC Millivolt	High trip 40 to 120%	74	252-PBT
DC Millivolt	Low trip 0 to 80%	74	252-PBS
Thermocouple	Type J, K, R, S and T. High trip 40 to 120%	49	252-PTO
Thermocouple	Type J, K, R, S and T. Low trip 0 to 80%	49	252-PTU

For models 252-PBS and 252-PBT specify millivolt input, auxiliary voltage and required options at time of ordering.

For models 252-PTO and 252-PTU specify thermocouple type, nominal temperature, auxiliary voltage and required options at time of ordering.

Provided by: K-Tech Inc. Ph:1 847 375 9524, Fx:1 847 375 9523
www.K-Tech.com info@k-tech.com

250 Series DIN Rail and Wall Mounted Relays

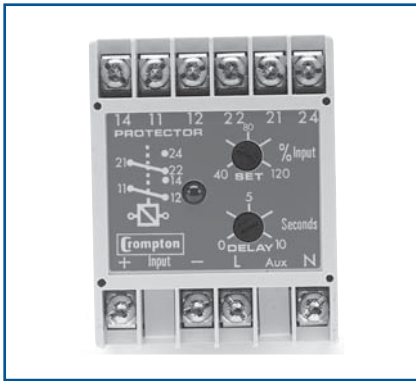

Specification – DC Millivolts / Thermocouple

DC Input	10mV, 50mV, 60mV, 75mV, 100mV, 150mV
Input Impedance	50KΩ
Source Impedance	100Ω maximum
Thermocouple	Types J, K, R, S, T 10 to 50mV
Thermocouple TBP	Thermocouple break protection upscale drive as standard
Thermocouple CJC	Cold junction compensation available on request
Thermocouple Overload	10 x rating continuously
Nominal Frequency	50/60Hz
Voltage Burden	3VA maximum
Voltage Overload	1.2 x rating continuously, 1.5 x rating for 10 seconds
Set Point Repeatability	>0.5% of full span
Differential (Hysteresis)	Preset at 1%. Values 1% to 15% available on request
Trip Level Adjustment	Low trip: 0 to 80% High trip: 40 to 120%
Time Delay Adjustable	0 to 10 seconds
AC Auxiliary Supply Voltage	100V, 110V, 120V, 208V, 220V, 240V, 480V, ±20%
DC Auxiliary Supply Voltage	12V, 24V, 48V, 110V or 125V, ±15%. Max ripple 15%
Auxiliary Voltage Burden	4VA (max)
Output Relay	Double pole change over
Relay Contact Rating	AC: 240V 5A, non inductive DC: 24V, 5A resistive
Relay Mechanical Life	0.2 million operations at rated loads
Relay Reset	Automatic
Operating Temperature	0°C to +60°C (0°C to +40°C for UL models)
Storage Temperature	-20°C to + 70°C
Temperature Co-efficient	0.05% per °C
Interference Immunity	Electrical stress surge withstand and non-function to ANSI/IEEE C37 90a
Enclosure Style	DIN rail with wall mounting facility
Material	Flame retardant polycarbonate/ABS
Enclosure Integrity	IP50
Compliant With	EMC, LVD, Safety Standard IEC 414 UL File No: E113067 recognized up to 600V CSA File No: LR52592 up to 150mV (252-PBS & 252-PBT only)
Dimensions	55mm (2.2") wide x 70mm (2.8") high x 112mm (4.4") deep
Weight	0.4Kg approx.

Connections

- 252-PBT
- 252-PBS
- 252-PTU
- 252-PTO

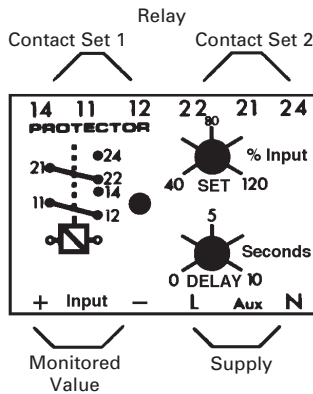

Dimensions

Model 252

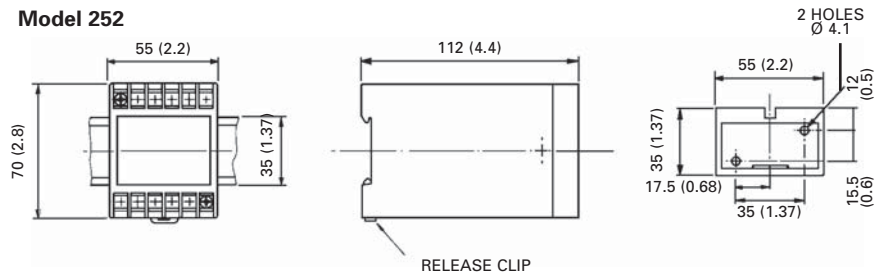

Provided by: K-Tech Inc. Ph:1 847 375 9524, Fx:1 847 375 9523
www.K-Tech.com info@k-tech.com

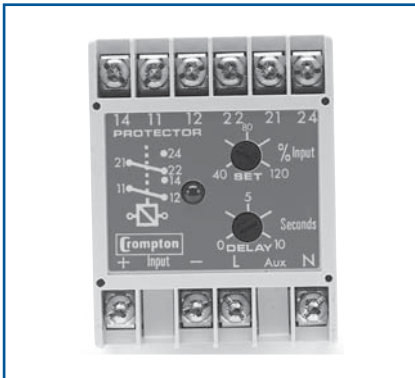

D.C. Transducer Trip

DC transducer protectors provide continuous surveillance of the DC process voltage or current signal. When the standard process signals move outside the setpoint limit the relay will operate. Combining the protection relay with a measuring transducer such as the Crompton 'Paladin' range can form specialized control products whenever self contained relays are not available.

Operation

The DC transducer protector relay offers user adjustable trip point (setpoint) and time delay settings. The time delay setting adjustment range is typically 0 to 10 seconds, although longer delays are available. As soon as the monitored signal moves outside of the setpoint limit, the time delay is activated, after which a trip will occur. The time delay prevents the relay from tripping for a predetermined period to prevent nuisance tripping. The products also feature an internal differential (hysteresis) setting of 1% to reduce nuisance tripping if the measured signal is noisy or unstable. These units require an auxiliary power supply.

Features

- High and low trip models
- Adjustable setpoint
- Adjustable time delay
- Internal differential
- LED trip indication
- Automatic reset
- Double pole relay contacts

Benefits

- Accepts standard process voltage or current signals
- Monitors forward/reverse Watts, VAR and VA
- Monitors under/over Watts, VAR and VA
- Power factor monitoring and control
- Nuisance tripping avoidance
- Customized options

Applications

- Switchgear
- Distribution systems
- Generator sets
- Control panels
- Process control
- Motor protection
- Transformers
- Overload protection

Approvals

- UL and CSA

'Over' High Trip Models

When the monitored signal exceeds the setpoint, the time delay is started. When the time has elapsed, the relay will energize and the red LED will illuminate to indicate the trip condition. The relay will automatically reset once the monitored signal falls below the setpoint minus the differential. When reset, the LED will extinguish and the relay de-energizes. The time delay is not active when resetting.

'Under' Low Voltage Models

When the monitored signal falls below the setpoint, the time delay is started. When the time has elapsed, the relay will de-energize and the red LED will extinguish to indicate the trip condition. The relay will automatically reset once the monitored signal rises above the setpoint plus the differential. When reset, the LED will illuminate and the relay energizes. The time delay is not active when resetting.

Options

250 series protector relays offer various customized options to suit individual requirements. Please consult factory.

- Adjustment ranges - different adjustment ranges are possible for the setpoint and time delay controls.
- Differential - Internally fixed value between 1% and 15%.
- Relay operation - standard models are fail safe, but the relays can be customized to energize or de-energize on trip.

Product Codes

Relay	Protection	ANSI No.	Catalog No.
DC Transducer	Low trip 0 to 80%	74	252-PBA
DC Transducer	High trip 40 to 120%	74	252-PBB
DC Transducer	High and low trip	74	253-PBV

Specify, input current/voltage, auxiliary voltage and required options at time of ordering.

Provided by: K-Tech Inc. Ph:1 847 375 9524, Fx:1 847 375 9523
www.K-Tech.com info@k-tech.com

250 Series DIN Rail and Wall Mounted Relays

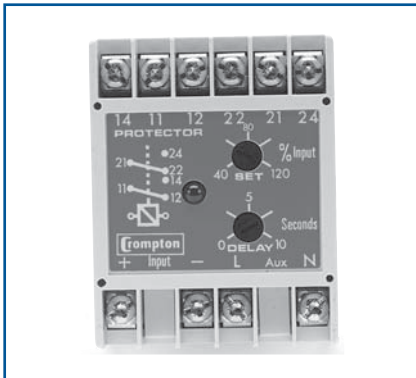

Specification – DC Transducer Trip

Nominal Input Current DC	0-1mA, 0-5mA, 0-10mA, 0-20mA, 4-20mA. Volt drop 1V
Nominal Input Voltage DC	1V to 50V, input resistance 10kΩ/V
Voltage Burden	3VA maximum
Overload	1.2 x rating continuously, 1.5 x rating for 10 seconds
Set Point Repeatability	>0.5% of full span
Differential (Hysteresis)	Preset at 1%. Values 1% to 15% available on request
Trip Level Adjustment	Low trip: 0 to 80% High trip: 40 to 120%
Time Delay Adjustable	0 to 10 seconds
AC Auxiliary Supply Voltage	100V, 110V, 120V, 208V, 220V, 240V, 480V, ±20%
DC Auxiliary Supply Voltage	12V, 24V, 48V, 110V or 125V, ±15%. Max ripple 15%
Auxiliary Voltage Burden	4VA (max)
Output Relay	Double pole change over
Relay Contact Rating	AC: 240V 5A, non inductive DC: 24V, 5A resistive
Relay Mechanical Life	0.2 million operations at rated loads
Relay Reset	Automatic
Operating Temperature	0°C to +60°C (0°C to +40°C for UL models)
Storage Temperature	-20°C to + 70°C
Temperature Co-efficient	0.05% per °C
Interference Immunity	Electrical stress surge withstand and non-function to ANSI/IEEE C37 90a
Enclosure Style	DIN rail with wall mounting facility
Material	Flame retardant polycarbonate/ABS
Enclosure Integrity	IP50
Compliant With	EMC, LVD, Safety Standard IEC 414 UL File No: E113067 recognized up to 600V CSA File No: LR52592 up to 240V AC
Model 252 Dimensions	55mm (2.2") wide x 70mm (2.8") high x 112mm (4.4") deep
Model 253 Dimensions	75mm (2.9") wide x 70mm (2.8") high x 112mm (4.4") deep
Weight	Model 252: 0.4Kg approx. Model 253: 0.6Kg approx

Connections

252-PBB
252-PBA

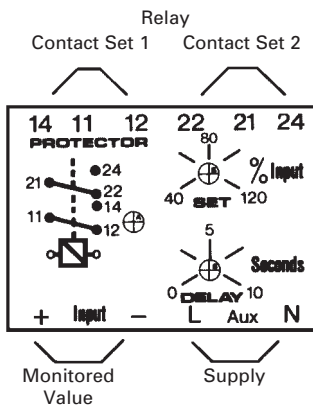

253-PBV

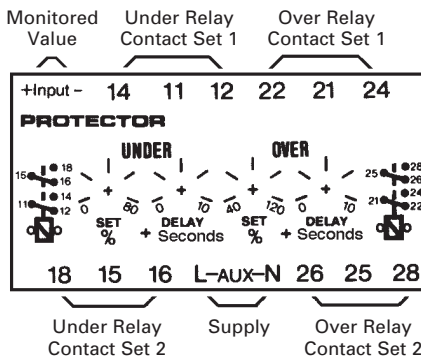

Dimensions

Model 252

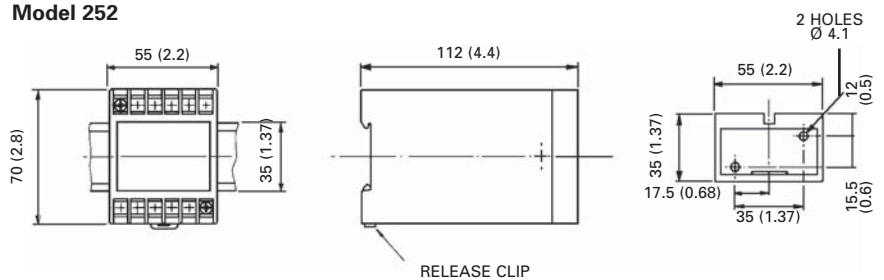

Model 253

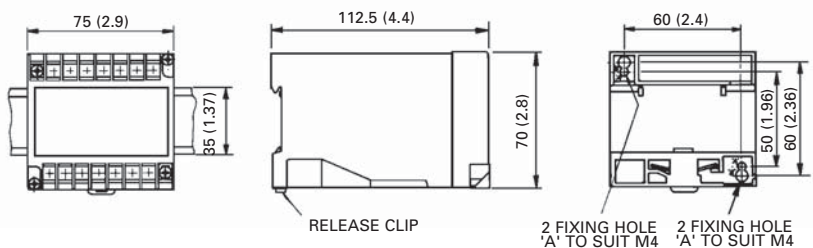

Provided by: K-Tech Inc. Ph:1 847 375 9524, Fx:1 847 375 9523
www.K-Tech.com info@k-tech.com



Speed Sensing

The 250 series speed sensing relay monitors rotating equipment and provides three output contacts which can be used to initiate alarm or shutdown signals. The relay also provides a tachometer output for speed indication. Speed sensing relays are ideally suited for engine and gas turbine monitoring and the protection of generator sets.

Operation

The speed sensing protector monitors the speed of rotation using a low cost magnetic pickup. Speed sensors are often used in generator set engines, gas turbines, motors, gear boxes or any rotating machines. The relay will detect under speed, over speed and stopped conditions, and the setpoint relays can be used to raise an alarm or shut down the equipment. The relay provides three user adjustable trip levels with LED relay state indication and a speed indicator output signal.

The product also offers an analog output that can be used to monitor or display the speed. The product operates from the 12V or 24V dc battery supply, and speed is measured and calculated from the number of sensor pulses per revolution. Since the sensor is magnetic, a rotating steel component can be used, such as the flywheel which has gear teeth. This will result in a large number of pulses per revolution, and lead to greater accuracy.

The protector continuously monitors the rotation speed, and updates the analog output signal. An output of 0.75 mA indicates normal speed (100%) while 1mA indicates 133% of nominal speed. The calibration point can easily be user adjusted. Three setpoint control adjustments allow setting of the desired speed limits for cranking, under speed and over speed.

Cranking Relay

The cranking relay detects if the engine is running or stopped. This relay can be used to ensure the cranking motor is disconnected once the engine has started running. Set the cranking setpoint just above the cranking motor speed. A red LED illuminates when the relay is energized, indicating a trip condition. The crank relay will only reset when the input frequency falls below 20% of the crank set point.

Under Speed Relay

The under speed relay detects when the normal running speed has been achieved. This can be used to enable the generator's electrical protection. It can also be used to trigger load shedding. A red LED illuminates when an under speed condition exists.

Over Speed Relay

The overspeed relay detects a stuck throttle or overshoot, a break in the sensor load will de-energize the over speed relay and can be used to shut down the engine. A red LED indicates over speed trip.

Fail Safe Operation

The relay will detect an open circuit speed sensor, and de-energize the overspeed relay.

Product Codes

Relay	Protection	ANSI No.	Catalog No.
Speed Sensing	Crank 10 to 50% Under speed 50 to 100% Over speed 100 to 130%	12/14	253-PH3

When ordering please supply the following information:

- The number of pulses per revolution, e.g. flywheel teeth = 30.
- The nominal running speed, e.g. 3600 RPM.
- The DC battery supply, e.g. 24 V dc.

The protector speed sensing relay provides three user adjustable trip levels with LED relay state indication and a speed indicator output signal. Please specify:

- SP1 - disengages the crank starter.
- SP2 - energizes protection or under-speed alarm.
- SP3 - alarms or trips on overspeed.

Features

- 1mA analog output
- 3 adjustable setpoints
- Adjustable time delay
- Internal differential
- LED trip indication
- Automatic reset
- 3 single pole relays
- Magnetic pick up input

Benefits

- Under/over speed monitoring
- Speed indicator output signal
- Zero reset cranking
- Nuisance tripping avoidance
- Customized options

Applications

- Marine panels
- Switchgear
- Distribution systems
- Generator sets
- Control panels
- Process control
- Motor protection
- Transformers
- Overload protection

Approvals

- UL recognized

250 Series DIN Rail and Wall Mounted Relays

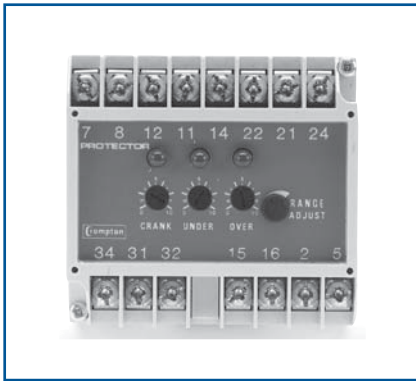

Specification – Speed Sensing

Pulse Input (Magnetic Input)	5V – 75V peak to peak
Frequency Input	0-1 to 0-10kHz
Overload	1.2 x rating continuously
Set Point Repeatability	>0.5% of full span
Differential (Hysteresis)	Preset at 2% (SP1 version resets at 20% of setting)
Trip Level Adjustment	SP1 (crank): 10% to 50% SP2 (under speed) : 50% to 100% SP3 (over speed) 100% to 130%
AC Auxiliary Supply Voltage	100V, 110V, 120V, 208V, 220V, 240V, 480V, ±20%
DC Auxiliary Supply Voltage	12V or 24V ±20%
Auxiliary Voltage Burden	3VA (max)
Analog Output	0.75mA for normal 100% speed. 1mA for 133% of nominal speed
Calibration Signal	0-1mA into 0-1000 ohms
Output Relay	3 single pole change over relays
Relay Contact Rating	AC: 240V 5A, non inductive DC: 24V, 5A resistive
Relay Mechanical Life	0.2 million operations at rated loads
Relay Reset	Automatic
Operating Temperature	0°C to +60°C (0°C to +40°C for UL models)
Storage Temperature	-20°C to + 70°C
Temperature Co-efficient	0.05% per °C
Interference Immunity	Electrical stress surge withstand and non-function to ANSI/IEEE C37 90a
Enclosure Style	DIN rail with wall mounting facility
Material	Flame retardant polycarbonate/ABS
Enclosure Integrity	IP50
Compliant With	EMC, LVD, Safety Standard IEC 414 UL File No: E113067 recognized up to 600V
Model 253 Dimensions	75mm (2.9") wide x 70mm (2.8") high x 112mm (4.4") deep
Weight	0.6Kg approx

Connections

253-PH3

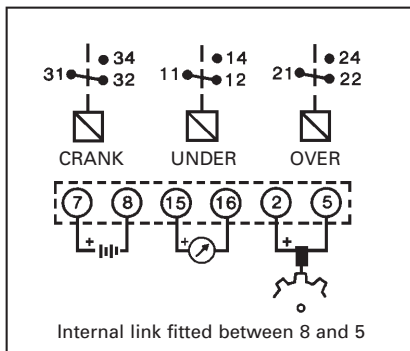

Dimensions

Model 253

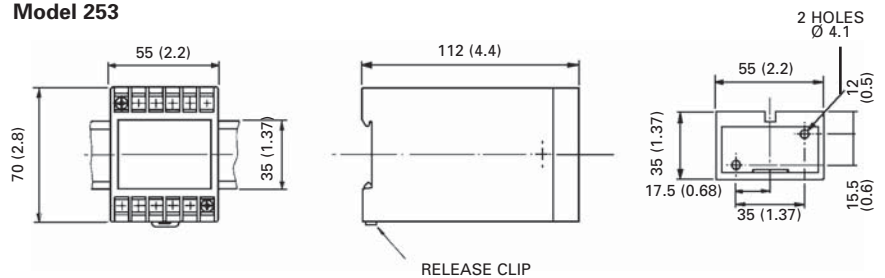

Provided by: K-Tech Inc. Ph:1 847 375 9524, Fx:1 847 375 9523
www.K-Tech.com info@k-tech.com