

## Features

### Relay module with forcibly guided contacts

- 7S.12 with 2 pole (1NO + 1 NC)
- 7S.14 with 4 pole (2 NO + 2 NC and 3 NO + 1 NC)
- 7S.16 with 6 pole (4 NO + 2 NC)

- For safety applications, with class A forcibly guided contact relays (EN 50205)
- For functional reliability in machinery and plant engineering according to EN 13849-1
- For railway applications; materials compliant with fire and smoke characteristics (UNI 11170-3); mechanical and climatic characteristics compliant with EN 61373 and EN 50155
- DC and AC supply versions
- 24 and 110 V DC versions with extended operating range (0.7...1.25)  $U_N$
- Coil status visual indication with LED
- 35 mm rail (EN 60715) mount

Screwless terminal



\* Single contact current  $\leq 6$  A,  
total NO contacts current  $\leq 12$  A

For outline drawing see page 6

**NEW** 7S.12....5110



• 2 pole (1 NO + 1 NC)

**NEW** 7S.14....0220/0310



• 4 pole (2 NO + 2 NC  
and 3 NO + 1 NC)

**NEW** 7S.16....0420



• 6 pole (4 NO + 2 NC)

### Contact specification

Contact configuration	1 NO + 1 NC	2 NO + 2 NC, 3 NO + 1 NC	4 NO + 2 NC
Rated current / Max. peak current A	6/15	6*/12	6*/12
Rated switching voltage V AC (50/60 Hz)	250	250	250
Rated load AC1 VA	1,500	1,500	1,500
Rated load AC15 (230 V AC) VA	700	500	500
Breaking capacity DC1: 30/110/220 V A	6/0.6/0.2	6/0.6/0.3	6/0.6/0.3
Breaking capacity DC13: 24 V A	1	1	1
Minimum switching load mW (V/mA)	60 (5/5)	60 (5/5)	60 (5/5)
Standard contact material	AgNi + Au (5 $\mu$ m)	AgNi with notched crown	AgNi with notched crown

### Coil specification

Nominal voltage ( $U_N$ )	V AC (50/60 Hz)	110...125 - 230...240	110...125 - 230...240	110...125 - 230...240
	V DC	12 - 24	12 - 24 - 110	12 - 24 - 110
Rated power VA (50 Hz) / W		2.3/1	2.3/1	2.3/1
Operating range	AC	(0.85...1.1) $U_N$	(0.85...1.1) $U_N$	(0.85...1.1) $U_N$
	DC	(0.8...1.2) $U_N$	(0.8...1.2) $U_N$	(0.8...1.2) $U_N$
	DC extended range (24 and 110 V only)	(0.7...1.25) $U_N$	(0.7...1.25) $U_N$	(0.7...1.25) $U_N$
Holding voltage AC/DC		0.45 $U_N$ /0.45 $U_N$	0.55 $U_N$ /0.55 $U_N$	0.55 $U_N$ /0.55 $U_N$
Must drop-out voltage AC/DC		0.1 $U_N$ /0.1 $U_N$	0.1 $U_N$ /0.1 $U_N$	0.1 $U_N$ /0.1 $U_N$

### Technical data

Mechanical life cycles		10 · 10 <sup>6</sup>	10 · 10 <sup>6</sup>	10 · 10 <sup>6</sup>
Electrical life at rated load AC1 cycles		100 · 10 <sup>3</sup>	100 · 10 <sup>3</sup>	100 · 10 <sup>3</sup>
Operate / release time ms		7/11	12/10	12/10
Insulation between coil and contacts (1.2/50 $\mu$ s) kV		6	6 (4 against 13-14)	6 (4 against 13-14)
Dielectric strength between open contacts V AC		1,500	1,500	1,500
Ambient temperature °C		-40...+70	-40...+70	-40...+70
Protection category		IP 20	IP 20	IP 20

Approvals (according to type)



**Ordering information**

Example: 7S series Relay module with forcibly guided contacts, 6 contact (4 NO + 2 NC) 6 A, supply voltage 24 V DC.

**7 S . 1 6 . 9 . 0 2 4 . 0 4 2 0**

**Series** \_\_\_\_\_  
**Type** \_\_\_\_\_  
 1 = 22.5 mm wide, cage-clamp terminals  
**Output** \_\_\_\_\_  
 2 = 2 contacts  
 4 = 4 contacts  
 6 = 6 contacts  
**Supply version** \_\_\_\_\_  
 8 = AC (50 /60 Hz)  
 9 = DC  
**Supply voltage** \_\_\_\_\_  
 See page 5

**Special versions**  
 0 = Standard  
**NO and NC contacts**  
 11 = 1 NO + 1 NC  
 22 = 2 NO + 2 NC  
 31 = 3 NO + 1 NC  
 42 = 4 NO + 2 NC  
**Contact material**  
 0 = AgNi  
 5 = AgNi+Au 5 µm

**Codes, Preferred selections for best availability are shown in bold.**

7S.12.9.012.5110	7S.14.9.012.0220	7S.16.9.012.0420
<b>7S.12.9.024.5110</b>	7S.14.9.012.0310	<b>7S.16.9.024.0420</b>
7S.12.8.120.5110	<b>7S.14.9.024.0220</b>	7S.16.9.110.0420
7S.12.8.230.5110	<b>7S.14.9.024.0310</b>	7S.16.8.120.0420
	7S.14.9.110.0220	7S.16.8.230.0420
	7S.14.9.110.0310	
	7S.14.8.120.0220	
	7S.14.8.120.0310	
	7S.14.8.230.0220	
	7S.14.8.230.0310	

Technical data

<b>Insulation according to EN 61810-1</b>				
Nominal voltage of supply system	V AC	230/400		
Rated insulation voltage	V AC	250		
Pollution degree		2		
<b>Insulation between coil and contact set</b>				
Type of Insulation		Reinforced *	Basic *	Reinforced *
Overvoltage category		III	III	II
Rated impulse voltage	kV (1.2/50 µs)	6	4	4
Dielectric strength	V AC	4,000	2,500	2,500
<b>Insulation between adjacent contacts</b>				
Type of Insulation		Reinforced *	Basic*	Reinforced *
Overvoltage category		III	III	II
Rated impulse voltage	kV (1.2/50 µs)	6	4	4
Dielectric strength	V AC	4,000	2,500	2,500
<b>Insulation between open contacts</b>				
Type of disconnection		Micro-disconnection		
Dielectric strength	V AC / kV (1.2/50 µs)	1,500 / 2.5		

\* Tables below indicate, for each 7S type, those contacts (R) meeting Reinforced Insulation Overvoltage category III, those contacts (R2) meeting Reinforced Insulation Overvoltage category II, and those contacts (B) meeting Basic Insulation Overvoltage category III.

<b>EMC specifications</b>			<b>Reference standard</b>		
Burst (5/50 ns)	on supply terminals		EN 61000-4-4	4 kV	
Surge (1.2/50 µs) on supply terminals	differential mode		EN 61000-4-5	1.5 kV	
<b>Terminals</b>			<b>solid cable</b>		<b>stranded cable</b>
Max. wire size		mm <sup>2</sup>	1 x 1.5		1 x 1.5
		AWG	1 x 14		1 x 16
Wire strip length		mm	9		
<b>Other data</b>			<b>7S.12</b>	<b>7S.14</b>	<b>7S.16</b>
Bounce time: NO/NC		ms	2/8	1/20	1/20
Vibration resistance (10...200) Hz: NO/NC		g	10/5	15/4	15/4
Shock resistance: NO/NC		g	20/6	25/13	25/13
Power lost to the environment	without contact current	W	0.8	0.8	0.8
	with rated current	W	1.4	2.3	2.8

Type of insulation between coil and contacts and between adjacent contacts

Code		
Type of Insulation	Overvoltage category	
R Reinforced	III	
B Basic	III	
R2 Reinforced	II	

7S.12....5110			
	Coil	13-14	21-22
Coil	—	R	R
13-14		—	B/R2
21-22			—

7S.14....0310					
	Coil	13-14	21-22	33-34	43-44
Coil	—	B	R	R	R
13-14		—	B	R	R
21-22			—	R	R
33-34				—	B/R2
43-44					—

7S.16....0420							
	Coil	13-14	21-22	31-32	43-44	53-54	63-64
Coil	—	B	R	R	R	R	R
13-14		—	B	R	R	R	R
21-22			—	R	R	R	R
31-32				—	B/R2	R	R
43-44					—	B/R2	R
53-54						—	B/R2
63-64							—

7S.14....0220					
	Coil	11-12	21-22	33-34	43-44
Coil	—	R	R	R	R
11-12		—	R	R	R
21-22			—	R	R
33-34				—	B/R2
43-44					—

Contact specifications

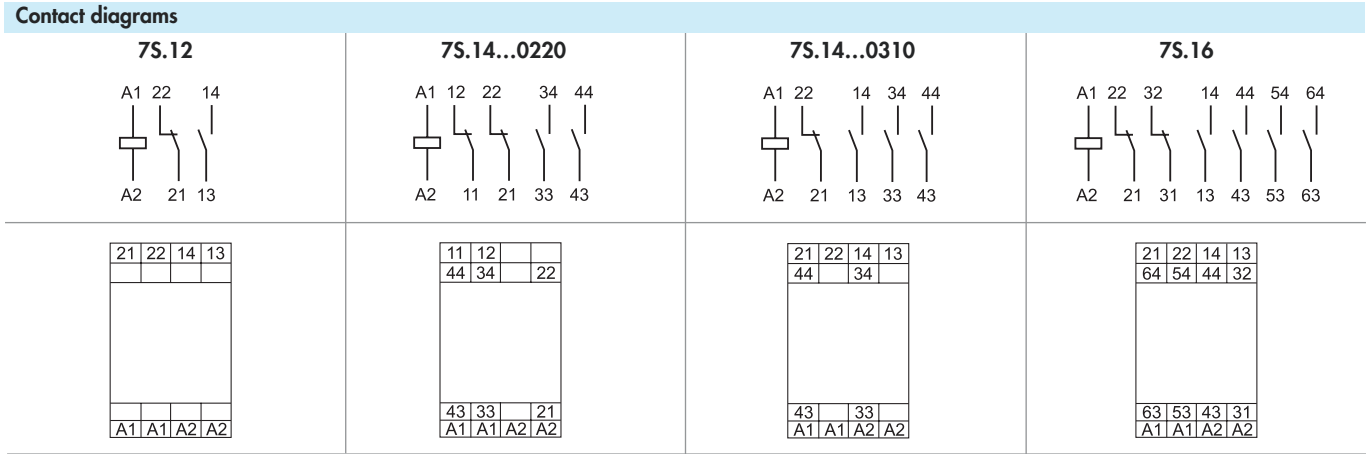

F 7S12 - Electrical life (AC) v contact current - 7S.12

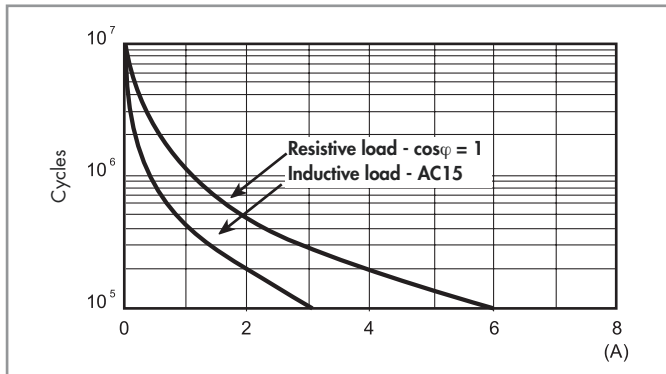

H 7S12 - Maximum DC breaking capacity - 7S.12

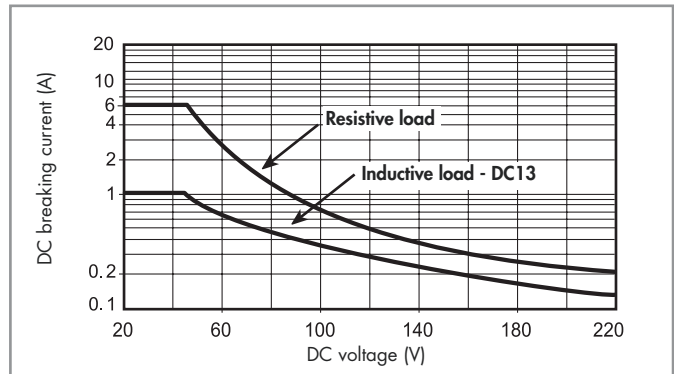

• When switching a load having voltage and current values under the curve, an electrical life of  $\geq 100 \cdot 10^3$  can be expected.

F 7S16 - Electrical life (AC) v contact current - 7S.14 / 7S.16

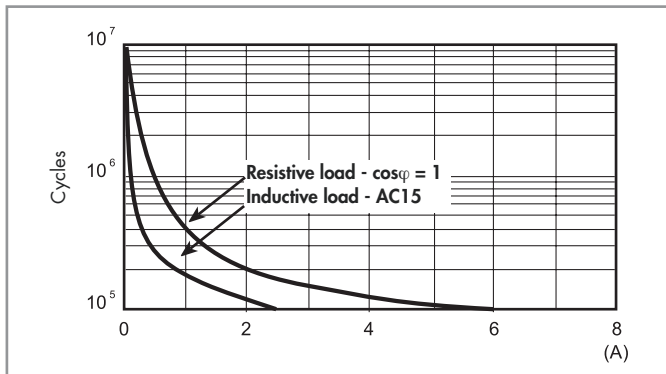

H 7S16 - Maximum DC breaking capacity - 7S.14 / 7S.16

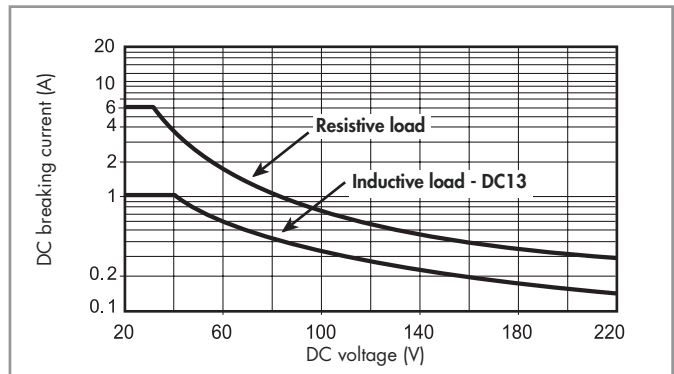

• When switching a load having voltage and current values under the curve, an electrical life of  $\geq 100 \cdot 10^3$  can be expected.

Coil specifications

DC coil data - type 7S.12

Nominal voltage	Coil code	Operating range		Rated input current at $U_N$	Rated power at $U_N$
		$U_{min}$	$U_{max}$		
$U_N$		V	V	$I_N$	W
V		V	V	mA	W
12	9.012	9.6	14.4	55	0.7
24	9.024	16.8	30	38.2	0.9

AC coil data - type 7S.12

Nominal voltage	Coil code	Operating range		Rated input current at $U_N$	Rated power at $U_N$
		$U_{min}$	$U_{max}$		
$U_N$		V	V	$I_N$	VA/W
V		V	V	mA	VA/W
110...125	8.120	93	138	9.5	1.1/1
230...240	8.230	195	264	9	2/0.8

DC coil data - type 7S.14 / 7S.16

Nominal voltage	Coil code	Operating range		Rated input current at $U_N$	Rated power at $U_N$
		$U_{min}$	$U_{max}$		
$U_N$		V	V	$I_N$	W
V		V	V	mA	W
12	9.012	9.6	14.4	56	0.7
24	9.024	16.8	30	28	0.7
110	9.110	77	138	9.2	0.7

AC coil data - type 7S.14 / 7S.16

Nominal voltage	Coil code	Operating range		Rated input current at $U_N$	Rated power at $U_N$
		$U_{min}$	$U_{max}$		
$U_N$		V	V	$I_N$	VA/W
V		V	V	mA	VA/W
110...125	8.120	93	138	8.9	1.1/0.9
230...240	8.230	195	264	8.5	2/0.8

R 7S - DC coil operating range v ambient temperature - 7S.12 / 7S.14 / 7S.16

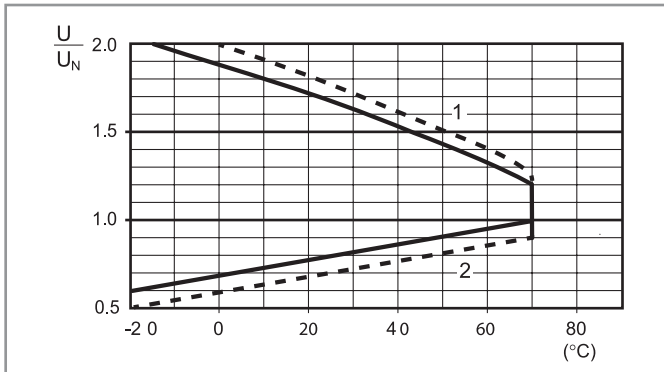

- 1 - Max. permitted coil voltage.
- 2 - Min. pick-up voltage with coil at ambient temperature.
- 24 and 110 V DC coils only (extended range)

R 7S - AC coil operating range v ambient temperature - 7S.12 / 7S.14 / 7S.16

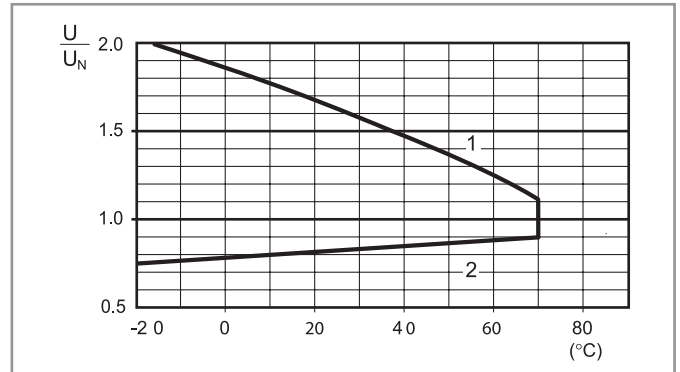

- 1 - Max. permitted coil voltage.
- 2 - Min. pick-up voltage with coil at ambient temperature.

# 7S Series - Relay module with forcibly guided contacts 6 A

## Outline drawings

7S  
Screwless terminal

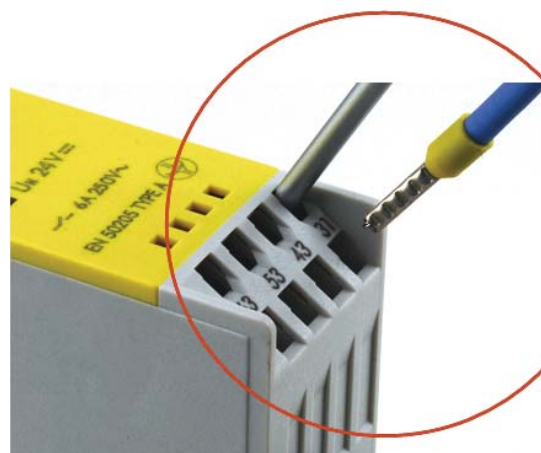
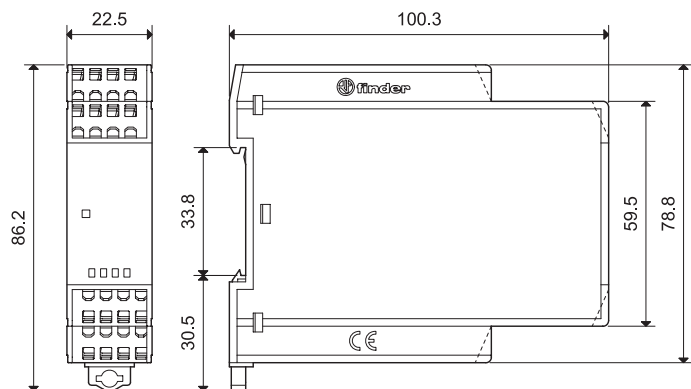

## Accessories



060.72

Sheet of marker tags, plastic, 72 tags, 6x12 mm 060.72